

EN Translation of the original operating and mounting instructions

GAM900S

Acceleration sensor for safety-rated applications

Baumer Germany GmbH & Co. KG
Bodenseelallee 7
DE-78333 Stockach
www.baumer.com

Printed in Germany · 10.22 · Version 1.08 · 81282108 · 11237695
Subject to modification in technic and design.
Errors and omissions excepted.

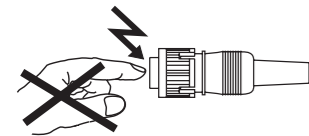

Mounting instructions

Avoid shocks and impacts on the housing as well as any deformation. Mounting tolerances may have an influence on the measured result.

Attach the acceleration sensor firmly (1.9 Nm) at its mounting bores using M4 screws. Proceed with alignment of coordinates (x-/x+/y-/y+/z-/z+). Particularly with user-specific configuration in deep pass filtering, an inclined mounting position will be indicated as offset in the acceleration signal.

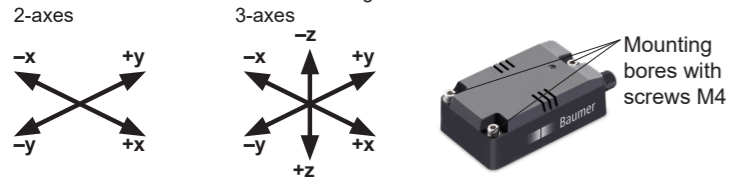

Dimensions

GAM900S - plastic housing, 1 x M12 connector

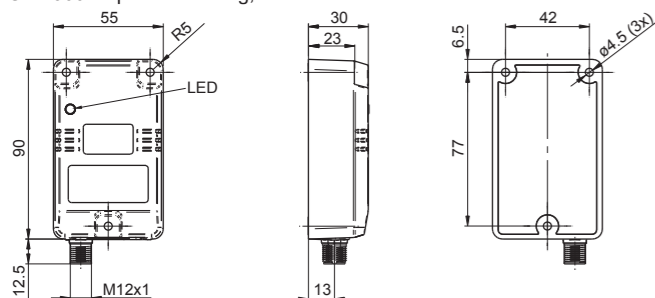

GAM900S - plastic housing, 2 x M12 connector

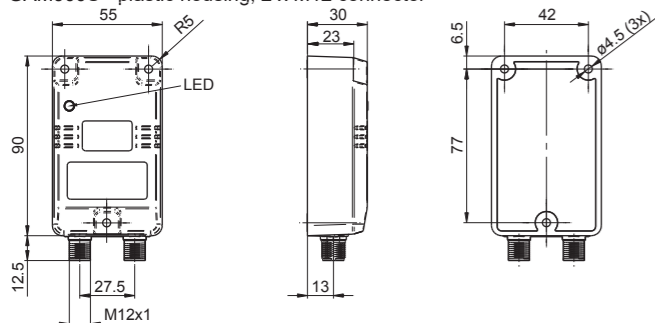

Safety instructions
Observe the legal obligations, directives and standards applicable for the use respectively intended use. Hence, the acceleration sensors of the GAM900S series are compliant with the standards of the EC type certification.

Only replace a defective by an identical product. The 8-digit reference number on the product label („item“) is mandatory here. The device must not be used when presenting any trace of damage. Do not operate the device beyond the limits specified in the data sheet. The applicable GAM900S (81138531) data sheet is available for download at www.baumer.com. Check all electrical connections prior to commissioning of the installation. Mounting, installation and e-connection or any other work performed at the acceleration sensor must be carried out by authorised experts only. Appropriate safety precautions must be taken to exclude any risk of personal injury and damage to operating equipment as a result of an acceleration sensor malfunction. Any failure in GAM900S operation is signaled by entry into „safe state“.

Product selection and installation
Selection and installation by authorised expert staff only.

Safety-relevant key characteristics	
Performance Level (ISO 13849)	PLd
Category (ISO 13849)	3
MTTF _d (ISO 13849)	393 years
DC _{avg} (ISO 13849)	86 %
TM (service life, ISO 13849)	20 years
Safety integrity level (IEC 61508 / EN 62061)	SIL2 / SIL CL2
PFH _d (IEC 61508)	2.5 E-09 1/h
PFD _{avg} (IEC 61508)	2.1 E-04
Error reaction time	<50 ms*

* The error reaction time does not include filtering delay in the acceleration information (customer-specific, optionally on request). Filter delay and balancing are defined by filter type and limit frequency and must be considered by the customer in safety certification of the installation. During filter balancing after initialisation (e.g. application of voltage supply), the safe limit verification is capable of value evaluation independent of the currently present acceleration.

Intended use of the device
The acceleration sensor is a precision instrument. It is intended to detect and monitor acceleration as well as to evaluate and supply the information in the form of electrical output signals for the downstream device. The acceleration sensor must not be used for any other purpose. Functionality is described in the data sheet and this mounting instruction. The customer is to verify whether the device is suitable for the intended application task.

Transport, storage and disposal
Only ever transport and store the acceleration sensor in its original packaging. Never drop the acceleration sensor – otherwise the device must no longer be used. Dispose of the components observing the legal regulations prevailing in your country.

GAM900S - aluminium housing, 1 x M12 connector

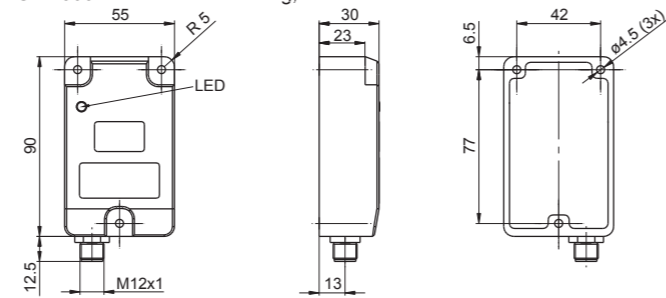

GAM900S - aluminium housing, 2 x M12 connector

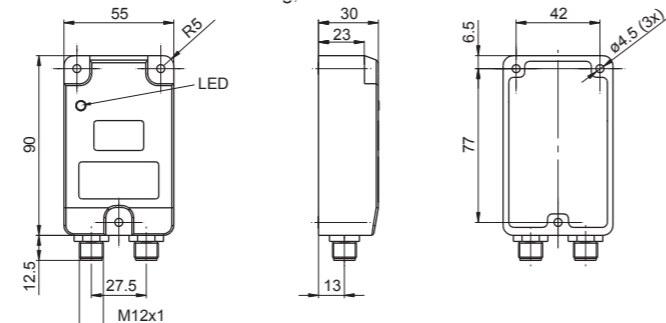

Safety functions
The safety function of the acceleration sensor is given through monitoring proper switching of relay 1 (safety relay) when exceeding the specified acceleration limit (user-defined by the ordering information in the data sheet). Standard release time is 1 second (see data sheet). Default configuration of other times on request. Switching operations of the safety relay, particularly at short release times, are seen by safety-related evaluation for safety function trigger. Acceleration sensors of the GAM900S series comply with safety function „relay switching at limit excess“ and all requirements of Performance Level PLd resp. safety integrity level SIL2 / SIL CL2 in line with ISO 13849 resp. IEC 61508 / EN 62061.

For safety reasons, relay evaluation by CO / NO contacts is mandatory („closed circuit principle“)

Product variant with series-connected safety relays (standard product and option -3502)

Safe state
Switching relay 1 is indicating the safe state.
- Contact CO / NO is open

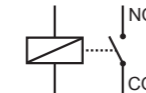

Following events will make the device enter the safe state:
- Exceeding the limit value (see ordering information in the data sheet)
- Failure (internal failure)
- In zero current state (without supply)

Standard operation
In standard operation (no failure and current acceleration within the limit), the following applies:
- Contact CO / NO is closed

Product variant with parallel outbound safety relays (option -3500 and -3501)

Both safety relays 1 and 1a must be evaluated individually and under safety aspects (see terminal assignment option -3500 or -3501). CO / NO contact behavior is identical to the abovementioned safety relays connected in series. In addition, both safety relays 1 and 1a provide outbound NC contact.

- Following applies to
- Safe state:
contact CO / NC closed
- Standard operation:
contact CO / NO closed

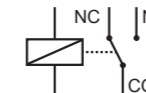

Note: Safety relay 1a configuration ever corresponds to the configuration of safety relay 1. Product variants with two M12 connectors feature additional, non-safety relevant relays that on request are configured by default according to customer specifications.

Maintenance/relay test
The customer is to ensure proper relay function by correspondingly documented tests **once a year**. Any other maintenance during the service life of the product is not required. Proper relay functionality can be tested using the test input or the CANopen restart command or by switching off the voltage supply. Customer is to verify proper switching of the relay contacts. Faulty relay switching after test initialization would call for device exchange.

Test input
Proper relay functionality is tested by twice a high signal applied at the respective pin. Signal level must exceed the voltage supply by 70 %. Signal period and pause between two high signals is between 1 and 3 seconds.

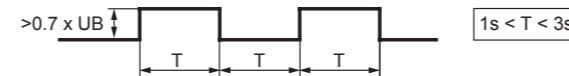

Details for CANopen communication and the restart command in particular can be found in the instruction manual.

Relay functionality
In standard operation (current acceleration within the limit), the following applies:
- Contact CO / NO is closed
- Contact CO / NC is open
Max. switching voltage: 30 V, max. switching current: 1.5 A. Switching of inductive load is not permitted.

Supply voltage UB / GND
The specified GAM900S voltage supply is 10...30 VDC. For protection against overvoltage, voltage supply must be backed by a **SELV / PELV-supply unit** compliant to EN 60950, which in the event of failure would supply a maximum voltage of 60 V.

E-connection
Do not perform any electrical modifications at the acceleration sensor or any wiring work while the device is live. Never plug or unplug the electrical connection while the acceleration sensor is live. Arrange for separate power supply of the acceleration sensor where working with consumers with high interference emissions.

Completely shield the acceleration sensor and connecting cable. Make sure the entire system is installed in line with EMC requirements. Ambient installations and cabling affect the electromagnetic compatibility of the acceleration sensor. Install acceleration sensor and supply cables separately or far away from cables with high interference emissions (frequency converters, contactors, etc). Use shielded connecting cables.

- GAM900S in plastic housing: Provide cable shield at the control unit.
- GAM900S in aluminium housing: Provide cable shield on both ends and connect with sensor housing via M12 connector.

Requirements according to EN 60204-1 need to be fulfilled when connected with cables longer than 20 m.

Terminal assignment

Standard / no option, connector M12, 12-pin

Connector 1	Pin	Description
	1	GND
	2	Test input
	3	UB
	4	Analog ground
	5	Analog output X
	6	Analog output Y
	7	Relay 1 / Safety contact NO*
	8	CAN Ground
	9	Relay 1 / Safety contact CO*
	10	n.c.
	11	CAN Low
	12	CAN High

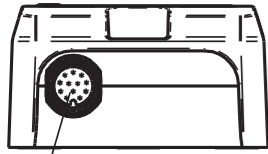
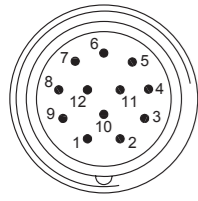

Connector 1

Standard / no option, connector 2 x M12, 12-pin

Connector 1	Pin	Description
	1	GND
	2	Test input
	3	UB
	4	Analog ground
	5	Analog output X
	6	Analog output Y
	7	Relay 1 / Safety contact NO*
	8	CAN Ground
	9	Relay 1 / Safety contact CO*
	10	Relay 1 / contact NC*
	11	CAN Low
	12	CAN High

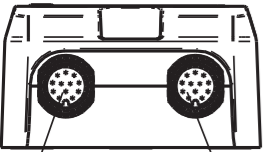
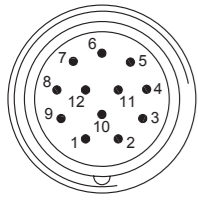

Connector 1

Connector 2	Pin	Description
	1	Relay 2 / Contact CO*
	2	Relay 3 / Contact NO*
	3	Relay 3 / Contact CO*
	4	Relay 3 / Contact NC*
	5	Relay 4 / Contact NO*
	6	Relay 4 / Contact CO*
	7	Relay 4 / Contact NC*
	8	CAN Ground
	9	Relay 2 / Contact NO*
	10	Relay 2 / Contact NC*
	11	CAN Low
	12	CAN High

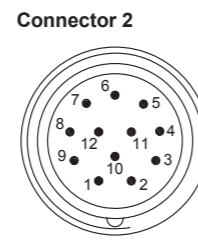

Standard / no option, connector 2 x M12, 5-pin (A-coded)

Male	Pin	Description
	1	Relay 1 / Safety contact CO*
	2	Relay 1a / Safety contact CO
	3	GND
	4	Test input
	5	UB

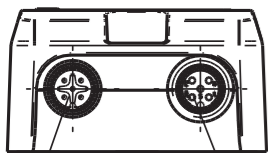

Male

Female	Pin	Description
	1	Relay 1 / Safety contact NO*
	2	Relay 1a / Safety contact NO
	3	CAN GND
	4	CAN High
	5	CAN Low

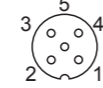

* Customer-specific relay configuration on request

Terminal assignment

Option -3500, Connector 2 x M12, 12-pin / Voltage supply and redundant safety relay at connector 2

Connector 1	Pin	Description
	1	GND
	2	Test input
	3	UB
	4	Analog ground
	5	Analog output X
	6	Analog output Y
	7	Relay 1 / Safety contact NO*
	8	CAN Ground
	9	Relay 1 / Safety contact CO*
	10	Relay 1 / Contact NC*
	11	CAN Low
	12	CAN High

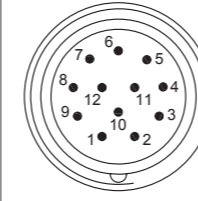

Connector 2	Pin	Description
	1	Relay 2 / Contact CO*
	2	Relay 1a / Safety contact NO
	3	Relay 1a / Safety contact CO
	4	Relay 1a / Contact NC
	5	n.c.
	6	GND
	7	UB
	8	CAN Ground
	9	Relay 2 / Contact NO*
	10	Relay 2 / Contact NC*
	11	CAN Low
	12	CAN High

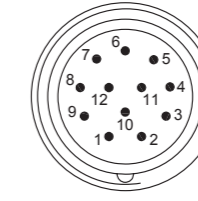

Option -3501, Connector 2 x M12, 12-pin / Safety relay parallel at connector 1 and 2

Connector 1	Pin	Description
	1	GND
	2	Test input
	3	UB
	4	Analog ground
	5	Analog output X
	6	Analog output Y
	7	Relay 1 / Safety contact NO*
	8	CAN Ground
	9	Relay 1 / Safety contact CO*
	10	Relay 1 / Contact NC*
	11	CAN Low
	12	CAN High

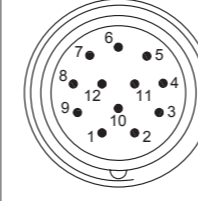

Connector 2	Pin	Description
	1	Relay 2 / contact CO*
	2	Relay 1a / Safety contact NO
	3	Relay 1a / Safety contact CO
	4	Relay 1a / Contact NC
	5	Relay 4 / Contact NO*
	6	Relay 4 / Contact CO*
	7	Relay 4 / Contact NC*
	8	CAN Ground
	9	Relay 2 / Contact NO*
	10	Relay 2 / Contact NC*
	11	CAN Low
	12	CAN High

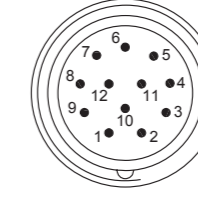

Option -3502, Connector 2 x M12, 12-pin / Voltage supply at connector 2

Connector 1	Pin	Description
	1	GND
	2	Test input
	3	UB
	4	Analog ground
	5	Analog output X
	6	Analog output Y
	7	Relay 1 / Safety contact NO*
	8	CAN Ground
	9	Relay 1 / Safety contact CO*
	10	n.c.
	11	CAN Low
	12	CAN High

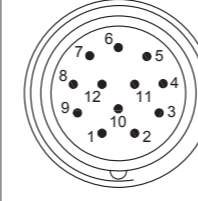

Connector 2	Pin	Description
	1	Relay 2 / Contact CO*
	2	Relay 3 / Contact NO*
	3	Relay 3 / Contact CO*
	4	Relay 3 / Contact NC*
	5	n.c.
	6	GND
	7	UB
	8	CAN Ground
	9	Relay 2 / Contact NO*
	10	Relay 2 / Contact NC*
	11	CAN Low
	12	CAN High

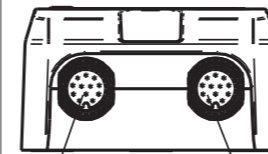
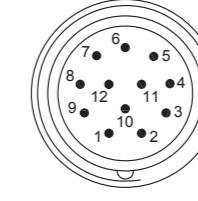

Connector 1

Connector 2

* Customer-specific relay configuration on request