

PMG10P - EtherNet/IP

Solid shaft $\varnothing 11$ mm with EURO flange B10 or housing foot B3 / EtherNet/IP / 13 bit ST / 16 bit MT
Speed switch, number of pulses and switching speed freely programmable

Overview

- Interface EtherNet/IP
- Magnetic sensing method
- Resolution: singleturn 13 bit, multiturn 16 bit
- Function display via LEDs
- Multiturn sensing with Energy Harvesting technology "MicroGen", without gear or battery
- Two-sided bearing system with hybrid bearings
- Special protection against corrosion CX (C5-M)



Picture similar

HUBNER
BERLIN
A Baumer Brand

microGen
Energy Harvesting

Technical data

Technical data - electrical ratings

Voltage supply	10...30 VDC
Short-circuit proof	Yes
Consumption w/o load	≤ 200 mA
Initializing time	≤ 500 ms after power on
Interface	EtherNet/IP
Function	Multiturn
Transmission rate	100 MBaud
Device address	HEX rotary switches in box or with "BOOTP/DHCP tool"
Steps per revolution	8192 / 13 bit
Number of revolutions	65536 / 16 bit
Additional outputs	Square-wave TTL/HTL, TTL/RS422
Sensing method	Magnetic
Interference immunity	EN 61000-6-2
Emitted interference	EN 61000-6-3
Programming interface	RS485 (≤ 600 m)
Programmable parameters	Bus system: see bus features Additional output (number of pulses), switch-off and switch-on speeds
Diagnostic function	Position or parameter error
Status indicator	DUO-LED and LEDs link/activity in bus connecting box 4 LEDs in device back side
Approval	CE UL approval / E217823 EAC

Technical data - electrical ratings (speed switch)

Switching accuracy	± 2 % (or 1 Digit)
Switching outputs	1 output (Open collector, solid state relay on request)

Technical data - electrical ratings (speed switch)

Output switching capacity	30 VDC; ≤ 100 mA
Switching delay time	≤ 20 ms
Technical data - mechanical design	
Size (flange)	$\varnothing 115$ mm
Shaft type	$\varnothing 11$ mm solid shaft
Flange	EURO flange B10 Housing foot B3
Protection EN 60529	IP 66/IP 67
Operating speed	≤ 6000 rpm
Range of switching speed	ns (off) = $\pm 2...6000$ rpm, factory setting 6000 rpm
Operating torque typ.	10 Ncm
Rotor moment of inertia	1 kgcm ²
Admitted shaft load	≤ 450 N axial ≤ 650 N radial
Material	Housing: aluminium alloy Shaft: stainless steel
Corrosion protection	IEC 60068-2-52 Salt mist for ambient conditions CX (C5-M) accord- ing to ISO 12944-2
Operating temperature	-40...+85 °C
Relative humidity	95 % non-condensing
Resistance	IEC 60068-2-6 Vibration 30 g, 10-2000 Hz IEC 60068-2-27 Shock 400 g, 1 ms
Weight approx.	2.7 kg (depending on version)
Connection	Bus connecting box Terminal box incremental

PMG10P - EtherNet/IP

Solid shaft $\varnothing 11$ mm with EURO flange B10 or housing foot B3 / EtherNet/IP / 13 bit ST / 16 bit MT
Speed switch, number of pulses and switching speed freely programmable

Optional

- Integrated speed switch programmable
- Additional output incremental programmable

PMG10P - EtherNet/IP

Solid shaft $\varnothing 11$ mm with EURO flange B10 or housing foot B3 / EtherNet/IP / 13 bit ST / 16 bit MT
Speed switch, number of pulses and switching speed freely programmable

Terminal assignment

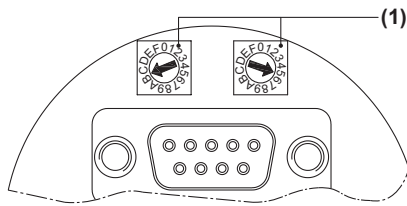

(1) IP address

Defined by HEX rotary switch.

Example: IP address B5_{hex}

Configuration via DHCP: 00_{hex}



View A1 (see dimension)

View into connector bus "voltage supply"

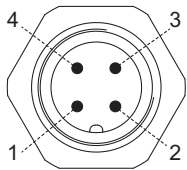

Connector M12 (male)
4-pin, A-coded

Pin	Connection
1	UB
2	dnu
3	GND
4	dnu

View A2 and A3 (see dimension)

View into connector bus „data transmission“

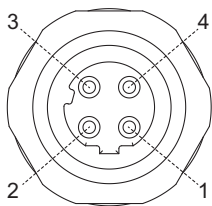

Connector M12 (female)
4-pin, D-coded

Pin	Connection
1	TxD+
2	RxD+
3	TxD-
4	RxD-

Terminal assignment

View B (see dimension)

Connecting terminal box
Programming interface / speed switch /
additional output II (HTL, TTL)

* Assignment depends on encoder version

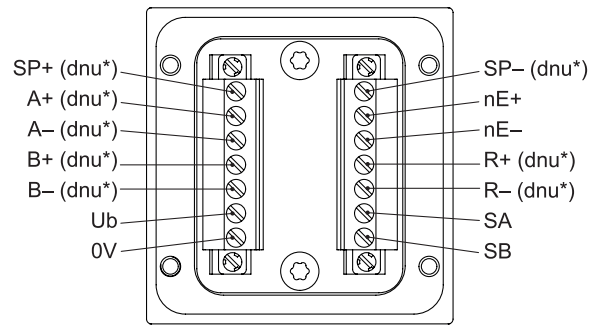

Terminal significance

Bus interface

Connection	Description
GND	Ground for UB
UB	Voltage supply 10...30 VDC
TxD+	Transmission data+
TxD-	Transmission data-
RxD+	Receiving data+
RxD-	Receiving data-
dnu	Do not use
Ub	Voltage supply
0V	Ground
A+	Output signal channel 1
A-	Output signal channel 1 inverted
B+	Output signal channel 2 (offset by 90° to channel 1)
B-	Output signal channel 2 inverted
R+	Zero pulse (reference signal)
R-	Zero pulse inverted
nE+	System OK+ / error output
nE-	System OK- / error output inverted
SP+	DSL_OUT1 / speed switch (open collector, solid state relay on request)
SP-	DSL_OUT2 / speed switch (0V, solid state relay on request)
SA	RS485+ / programming interface
SB	RS485- / programming interface
dnu	Do not use

PMG10P - EtherNet/IP

Solid shaft $\varnothing 11$ mm with EURO flange B10 or housing foot B3 / EtherNet/IP / 13 bit ST / 16 bit MT
Speed switch, number of pulses and switching speed freely programmable

EtherNet/IP features

Bus protocol	EtherNet/IP
Device profile	Encoder Device, type 22hex, according to CIP specification
Features	<ul style="list-style-type: none"> 100 MBaud Fast Ethernet IP address programmable Automatic IP address designation (DHCP) Rotating direction, resolution, total resolution and preset are programmable according to CIP specification
Process data	Position value, warning flag, error flag, Assembly Instances 1 and 2 according to CIP specification

Output signals

Additional output II (HTL/TTL)

At positive rotating direction (*see dimension*)

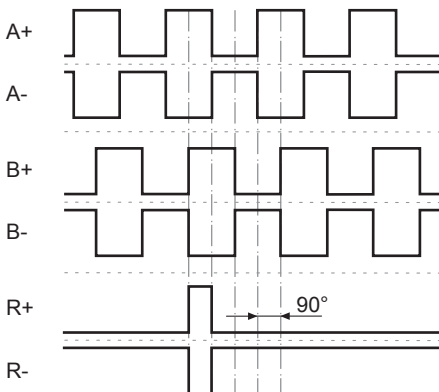

Trigger level

Incremental HTL/TTL

Electrically isolated:
The output TTL/HTL ($V_{in} = V_{out}$) at the additional output II is electrically isolated and requires a separate power supply.

Trigger level	TTL/RS422
High / Low	≥ 2.5 V / ≤ 0.5 V
Transmission length	≤ 550 m @ 100 kHz
Output frequency	≤ 600 kHz
Trigger level	TTL/HTL ($V_{in} = V_{out}$)
High / Low	≥ 2.5 V / ≤ 0.5 V (TTL) $\geq U_b - 3$ V / ≤ 1.5 V (HTL)
Transmission length	≤ 550 m @ 100 kHz (TTL) ≤ 350 m @ 100 kHz (HTL)
Output frequency	≤ 600 kHz (TTL); ≤ 350 kHz (HTL)

Switching characteristics speed switch

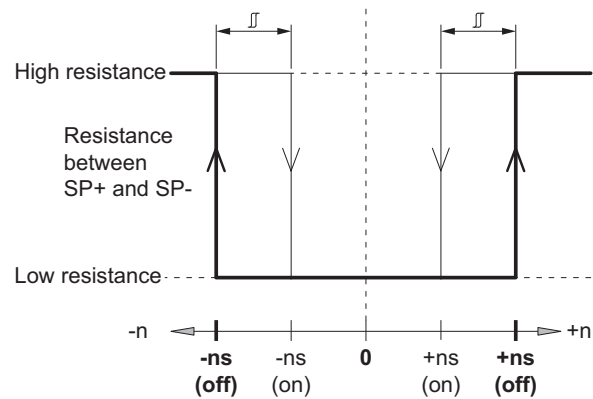

n	Speed
+ns (off)	Switch-off speed at shaft rotation in positive rotating direction (<i>see dimension</i>).
-ns (off)	Switch-off speed at shaft rotation in negative rotating direction (<i>see dimension</i>).
	Switching hysteresis Δ : 10...100 % (factory setting = 10 % min. 1 Digit)
+ns (on)	Switch-on speed at shaft rotation in positive rotating direction (<i>see dimension</i>).
-ns (on)	Switch-on speed at shaft rotation in negative rotating direction (<i>see dimension</i>).

PMG10P - EtherNet/IP

Solid shaft $\varnothing 11$ mm with EURO flange B10 or housing foot B3 / EtherNet/IP / 13 bit ST / 16 bit MT
Speed switch, number of pulses and switching speed freely programmable

Dimensions

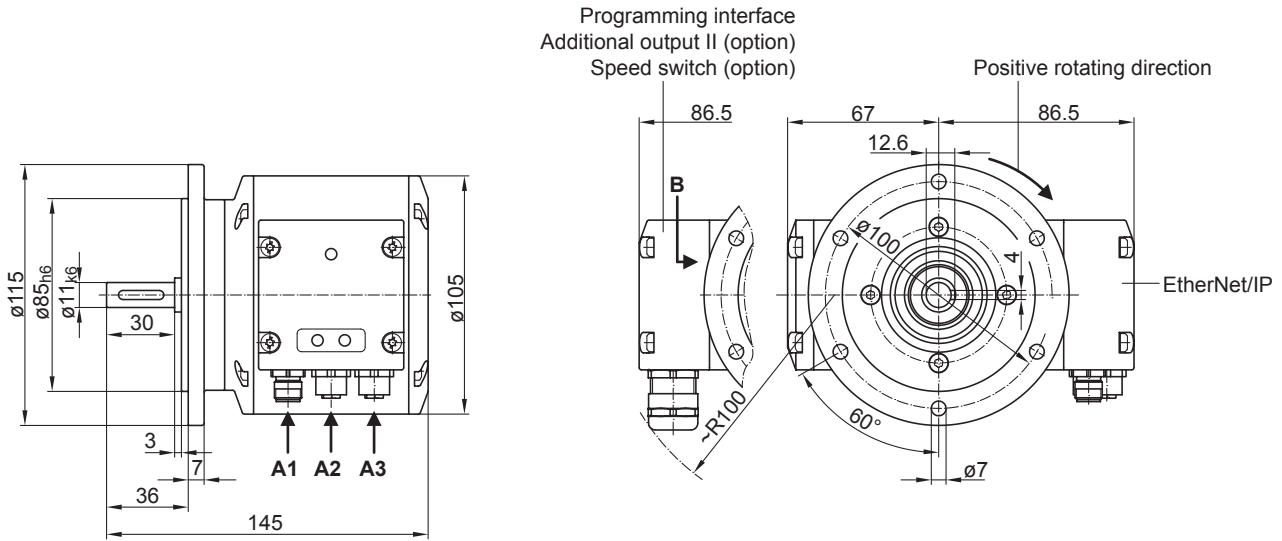

Version with Euro flange (B10)

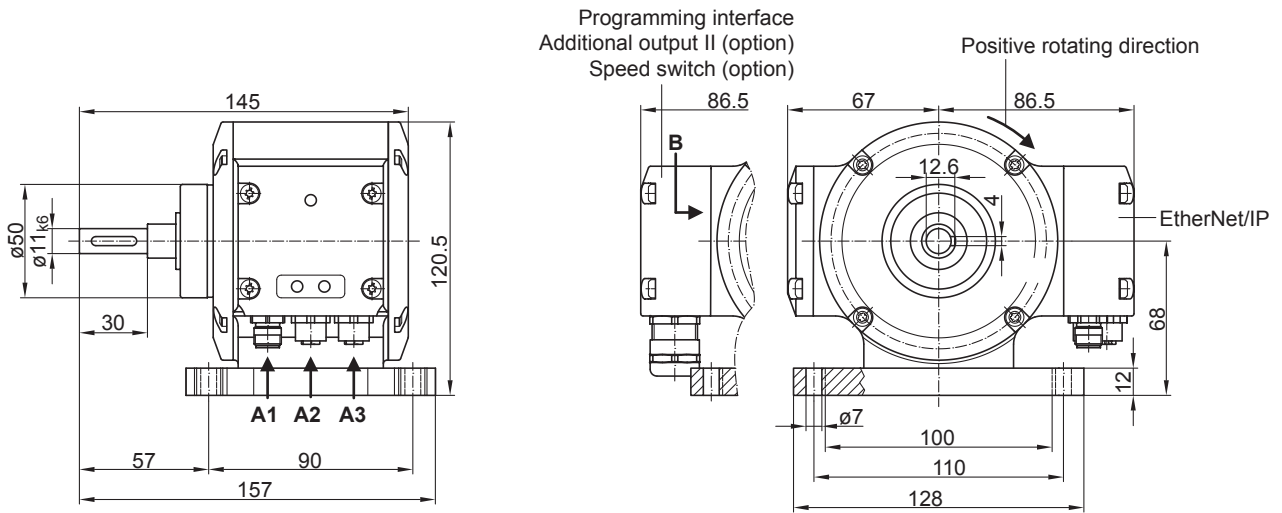

Version with housing foot (B3)

PMG10P - EtherNet/IP

Solid shaft ø11 mm with EURO flange B10 or housing foot B3 / EtherNet/IP / 13 bit ST / 16 bit MT
 Speed switch, number of pulses and switching speed freely programmable

Ordering reference

	PMG10P	#	-	S	H	#	.	1	G	EN	.	3	#	0	0	#	.	A
Product	Absolute encoder	PMG10P																
Digital speed switch	With ⁽¹⁾			D														
	Without			-														
Shaft type	Solid shaft				S													
Flange (Solid shaft)	EURO flange B10, hybrid bearings					H												
Protection class	IP 66 and IP 67, optimized for dusty, abrasive environment									D								
	IP 66 and IP 67, optimized for oily, wet environment									L								
Solid shaft	Ø11 mm, featherkey 4 mm							1										
Connection	Bus connecting box with 3 connectors M12, radial + terminal box with 1 cable gland M20, radial									G								
Supply voltage (field bus)	10...30 VDC, EtherNet/IP										EN							
Resolution singleturn position	13 Bit												3					
Resolution multiturn position	No multiturn signal													0				
	16 Bit													6				
Resolution speed	No speed signal														0			
Resolution supplement I	No additional output I															0		
Resolution supplement II	No additional output II																0	
	1024 ppr TTL/HTL push-pull (Vin=Vout), 6 channels, electrically isolated ⁽²⁾																5	
	1024 ppr TTL (RS422), 6 channels ⁽²⁾																6	
Operating temperature	-40...+85 °C																	

(1) Switching speed 6000 rpm / factory setting, programmable

(2) Factory setting, programmable

Accessories

Mounting accessories

	Spring disk coupling K 35 (shaft ø6...12 mm)
	Spring disk coupling K 50 (shaft ø11...16 mm)
	Spring disk coupling K 60 (shaft ø11...22 mm)
11238694	CAM12.WS13-11238694

Programming accessories

11190106	Z-PA.SDL.1 - WLAN-Adapter
----------	---------------------------