



Optical sensors Series FHDK 04

The smallest diffuse sensor with defined sensing distance and background suppression in the world

Sensor Solutions

Motion Control

Vision Technologies

Process Instrumentation

Diffuse sensor FHDK 04

4 x 45 x 6 mm small and high-precision optics

Highlights

- Extremely small (4 x 45 x 6 mm)
- Defined sensing distance and highly efficient background suppression
- Small light spot (1,8 mm) permits detection of very small objects
- Suppression of interference when several sensors are used side by side
- Fixed sensing distance prevents unintentional misadjustment of the sensor
- No adjustment necessary
- Simple installation
- Compatible with  **IO-Link**

Your benefits

- Accurate and repeatable detection of objects. Detection occurs almost independently of:
 - surface structure
 - color
- Detection of very small objects
- Reliable suppression of objects located outside the defined sensing distance
- Insensitive to:
 - ambient light
 - dirt

The details of background suppression

Diffuse sensors with background suppression evaluate the angle of the reflected light. With two receiver diodes, it is possible to establish whether the object is located within the sensing distance (T1) or whether it is an interfering object in the background (T2).

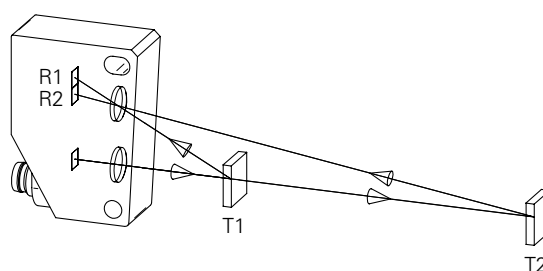

Illustration of the principle

FHDK 04 sensors in automation technology



Transfer systems

By installing the sensor directly in the extrusion frame, detection of the object carrier or other articles is protected and wastes no precious space. Mounting adapters simplify rapid installation.

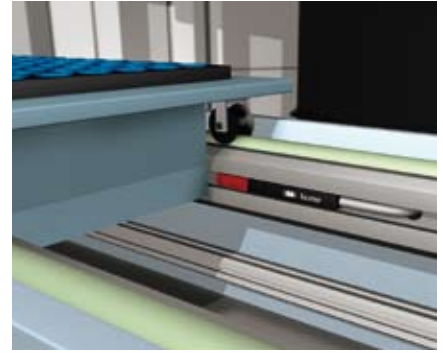

Material detection

The separated material transported from the vibration conveyor is accurately detected regardless of its color, surface and soiling. The sensor is easily installed. Time-consuming adjustments such as teach-in procedures are unnecessary.

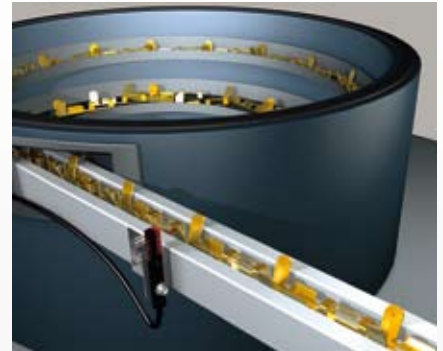

Tablet detection

Several FHDK 04s can be mounted one beside the other without interference between the sensors. Even small objects such as tablets or similar items can be efficiently detected with little space requirement.



Typical fields of application

- Transfer systems
- Handling/robotics industry
- Special machines
- Laboratory automation
- Semiconductor industry
- Pharmaceutical packaging machines

Other miniature and fiber-optic sensors

Baumer provides the right sensor solution for every application. For example, our *MINOS* series offers small dimensions as well as adjustable sensing distances in cable and plug variants. Numerous different combinations of fiber-optic sensors and optical fibers are available depending on the field of application.



Photoelectric sensor *MINOS*



Plastic fiber-optic sensor

The most important technical properties

Function	Diffuse sensor with background suppression
Light source	Pulsed LED
Spot size (at the focus) at 50 mm	1,8 mm
Soiling/adjustment indicator	Flashing reception indicator
Interference suppression	Yes
Response time	< 0,5 ms
Output circuit	Push-pull
Dimensions (WxHxD)	4 x 45 x 6 mm
Protection class	IP 65
Temperature range	-10...+50 °C

The right solution for every connection



Sensing distance 30 mm

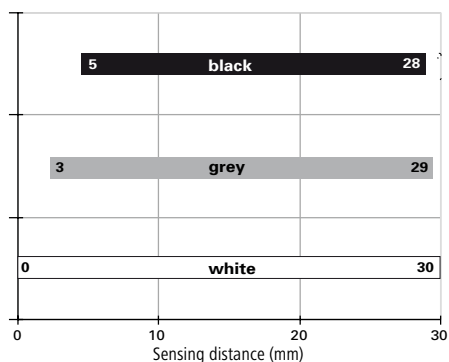

Sensing distance 50 mm

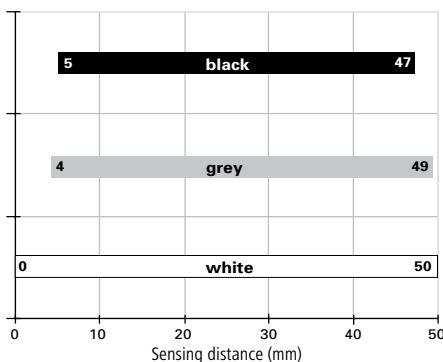

Dimension drawing

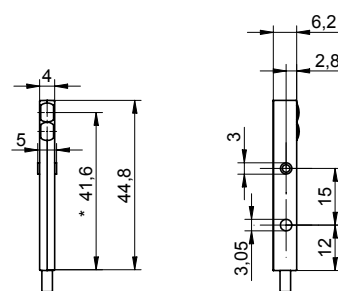

* Transmitter axis

Ordering information	Sensing distance	Function
FHDK 04G6101	30 mm	Light operate (PNP), dark operate (NPN)
FHDK 04G6101/KS35A	30 mm	Light operate (PNP), dark operate (NPN)
FHDK 04G6111	30 mm	Dark operate (PNP), light operate (NPN)
FHDK 04G6111/KS35A	30 mm	Dark operate (PNP), light operate (NPN)
FHDK 04G6102	50 mm	Light operate (PNP), dark operate (NPN)
FHDK 04G6102/KS35A	50 mm	Light operate (PNP), dark operate (NPN)
FHDK 04G6112	50 mm	Dark operate (PNP), light operate (NPN)
FHDK 04G6112/KS35A	50 mm	Dark operate (PNP), light operate (NPN)

Mounting kit

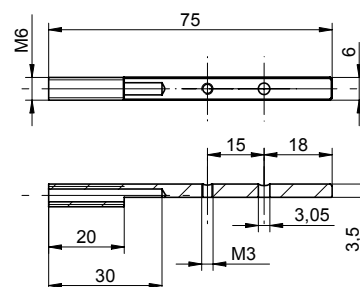

Part number: 10163196

Mounting adapter

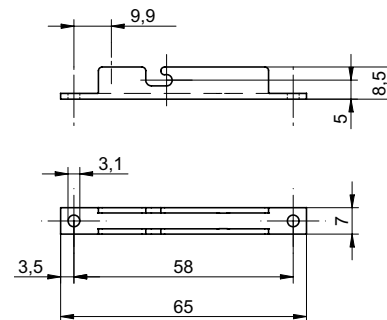

Part number: 10163299

More info on Series 04 at www.baumerelectric.com/en/206.html

Baumer

Baumer International

Baumer Group · International Sales
 P.O. Box · Hummelstrasse 17 · CH-8501 Frauenfeld
 Phone +41 (0)52 728 1122
 Fax +41 (0)52 728 1144
sales@baumergroup.com
www.baumergroup.com

Find your local partner
www.baumergroup.com/worldwide