

**Overview**

- M12, male, A-coded, 3-poles; PUR, 300 cm; M8, female, A-coded, 3-poles
- Dragchain capable; suitable for robotics  $\pm 180$  °/m
- Head A: IP65, IP66K, IP67; Head B: IP65, IP66K, IP67
- Cable: good resistance against chemicals, flames, oils
- Halogen free



**Technical data**

**Side A**

Head A: Connection	M12
Head A: Angle cable outlet	0°
Head A: Gender	Male
Head A: Coding	A
Head A: No. of poles	3
Head A: LED	No
Head A: Width across flats	AF13
Head A: Tightening torque	0.6 Nm
Head A: Knurled nut material	Zinc-pressure die casting, surface Ni
Head A: Body color	Black
Labeling sleeve side A	Yes

**Side B**

Head B: Connection	M8
Head B: Angle cable outlet	90°
Head B: Gender	Female
Head B: Coding	A
Head B: No. of poles	3
Head B: LED	No
Head B: Width across flats	AF9
Head B: Tightening torque	0.4 Nm
Head B: Knurled nut material	Zinc-pressure die casting, surface Ni
Head B: Body color	Black
Head B: Gasket material	FKM
Labeling sleeve side B	Yes

**Cables**

Cable length	300 cm
Length tolerance	+ 10 cm
Shielded	No
Conductor structure	32 × 0.1 mm
AWG	24
External sheath: Material	PUR
External sheath: Color	Black
Cable diameter	4.1 mm ± 5%
Wire cross section	0.25 mm <sup>2</sup>

**Electrical data**

Operating voltage	max. 50 V AC / 60 V DC
-------------------	------------------------

**Electrical data**

Operating voltage (only UL listed)	30 V AC/DC
Nominal voltage	300 V
Contact resistance	max. 30 mOhm
Operating current per contact	max. 4 A

**Mechanical data**

Head A: Degree of protection	IP65, IP66K, IP67
Head B: Degree of protection	IP65, IP66K, IP67
Bending radius (mobile)	min. 10 × outer diameter
Bending radius (fixed)	min. 5 × outer diameter
No. of bending cycles (C-track)	approx. 10000000 Cycles
Torsion speed	max. 35 cycles/min
Torsion stress in °	± 180 °/m
No. of torsion cycles	approx. 2000000 Cycles
Acceleration (C-track)	max. 10 m/s <sup>2</sup>
Travel speed (C-track)	max. 3 m/s

**Environmental conditions**

Temperature range (mobile)	- 25 ...+ 80 °C
Temperature range (fixed)	- 25 ...+ 80 °C
Cable: Temperature range (fixed)	- 40 ...+ 80 °C
Dragchain capable	Yes
Head A: Chemical resistance	No
Head A: Flame resistance	HB (UL 94)
Head A: Oil resistance	ASTM 1 oil, mineral oils, limited to hydraulic oils
Head A: Acid and alkali resistant	No
Head A: Pollution degree	3
Head B: Chemical resistance	No
Head B: Flame resistance	HB (UL 94)
Head B: Oil resistance	ASTM 1 oil, mineral oils, limited to hydraulic oils

**Technical data**

**Environmental conditions**

Head B: Acid and alkali resistant	No
Head B: Pollution degree	3
Cable: Chemical resistance	Good (DIN EN 60811-404)
Cable: Flame resistance	Conform UL 1581 §1090 (H), CSA FT2, IEC 60332-2-2

**Environmental conditions**

Cable: Oil resistance	Good (DIN EN 60811-404)
Cable: Silicone-free	Yes

**Commercial data**

Eclass	27060311
--------	----------

**Side A**

**Technical drawing**



**Side B**

**Technical drawing**

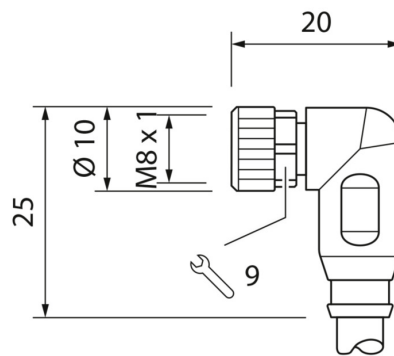

**Coding**

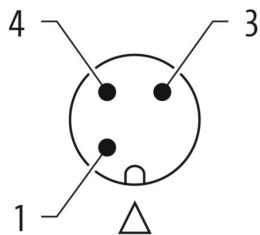

**Coding**

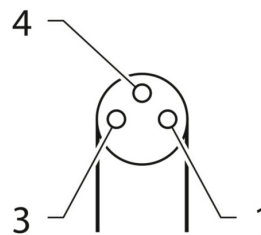

**Connection diagram**



**Dimension drawing**

