

**Overview**

- M12, male, A-coded, 3-poles; PUR, 1500 cm; M8, female, A-coded, 3-poles
- Dragchain capable; suitable for robotics  $\pm 180^\circ/\text{m}$
- Head A: IP65, IP66K, IP67; Head B: IP65, IP66K, IP67
- Cable: good resistance against chemicals, flames, oils
- Halogen free

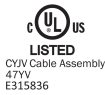
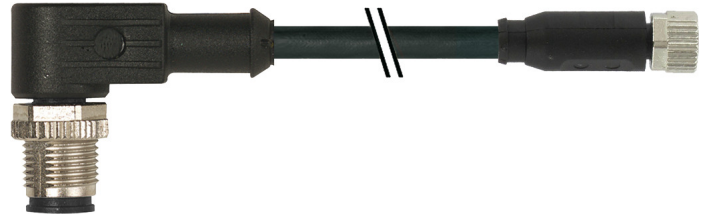

**Technical data**

**Side A**

|                              |                                       |
|------------------------------|---------------------------------------|
| Head A: Connection           | M12                                   |
| Head A: Angle cable outlet   | 90°                                   |
| Head A: Gender               | Male                                  |
| Head A: Coding               | A                                     |
| Head A: No. of poles         | 3                                     |
| Head A: LED                  | No                                    |
| Head A: Width across flats   | SW13                                  |
| Head A: Tightening torque    | 0.6 Nm                                |
| Head A: Knurled nut material | Zinc-pressure die casting, surface Ni |
| Head A: Body color           | Black                                 |
| Labeling sleeve side A       | Yes                                   |

**Side B**

|                              |                                       |
|------------------------------|---------------------------------------|
| Head B: Connection           | M8                                    |
| Head B: Angle cable outlet   | 0°                                    |
| Head B: Gender               | Female                                |
| Head B: Coding               | A                                     |
| Head B: No. of poles         | 3                                     |
| Head B: LED                  | No                                    |
| Head B: Width across flats   | SW9                                   |
| Head B: Tightening torque    | 0.4 Nm                                |
| Head B: Knurled nut material | Zinc-pressure die casting, surface Ni |
| Head B: Body color           | Black                                 |
| Labeling sleeve side B       | Yes                                   |

**Cables**

|                           |                      |
|---------------------------|----------------------|
| Cable length              | 1500 cm              |
| Length tolerance          | $\pm 22.5$ cm        |
| Shielded                  | No                   |
| Conductor structure       | 32 $\times$ 0.1 mm   |
| AWG                       | 24                   |
| External sheath: Material | PUR                  |
| External sheath: Color    | Black                |
| Cable diameter            | 4.1 mm $\pm$ 5%      |
| Wire cross section        | 0.25 mm <sup>2</sup> |

**Electrical data**

|                                    |                        |
|------------------------------------|------------------------|
| Operating voltage                  | max. 50 V AC / 60 V DC |
| Operating voltage (only UL listed) | 30 V AC/DC             |

**Electrical data**

|                               |              |
|-------------------------------|--------------|
| Nominal voltage               | 300 V        |
| Contact resistance            | max. 30 mOhm |
| Operating current per contact | max. 4 A     |

**Mechanical data**

|                                 |                                 |
|---------------------------------|---------------------------------|
| Head A: Degree of protection    | IP65, IP66K, IP67               |
| Head B: Degree of protection    | IP65, IP66K, IP67               |
| Bending radius (mobile)         | min. 10 $\times$ outer diameter |
| Bending radius (fixed)          | min. 5 $\times$ outer diameter  |
| No. of bending cycles (C-track) | approx. 10000000 Cycles         |
| Torsion speed                   | max. 35 cycles/min              |
| Torsion stress in °             | $\pm 180^\circ/\text{m}$        |
| No. of torsion cycles           | approx. 2000000 Cycles          |
| Acceleration (C-track)          | max. 10 m/s <sup>2</sup>        |
| Travel speed (C-track)          | max. 3 m/s                      |

**Environmental conditions**

|                                   |   |
|-----------------------------------|---|
| Temperature range (mobile)        | - 25 ...+ 80 °C                                     |
| Temperature range (fixed)         | - 25 ...+ 80 °C                                     |
| Cable: Temperature range (fixed)  | - 40 ...+ 80 °C                                     |
| Dragchain capable                 | Yes   |
| Head A: Chemical resistance       | No  |
| Head A: Flame resistance          | HB (UL 94)  |
| Head A: Oil resistance            | ASTM 1 oil, mineral oils, limited to hydraulic oils |
| Head A: Acid and alkali resistant | No  |
| Head A: Pollution degree          | 3   |
| Head B: Chemical resistance       | No  |
| Head B: Flame resistance          | HB (UL 94)  |
| Head B: Oil resistance            | ASTM 1 oil, mineral oils, limited to hydraulic oils |
| Head B: Acid and alkali resistant | No  |
| Head B: Pollution degree          | 3   |

**Technical data**

**Environmental conditions**

|                            |   |
|----------------------------|---|
| Cable: Chemical resistance | Good (DIN EN 60811-404)                           |
| Cable: Flame resistance    | Conform UL 1581 §1090 (H); CSA FT2; IEC 60332-2-2 |

**Environmental conditions**

|                       |                         |
|-----------------------|-------------------------|
| Cable: Oil resistance | Good (DIN EN 60811-404) |
| Cable: Silicone-free  | Yes                     |

**Side A**

**Technical drawing**

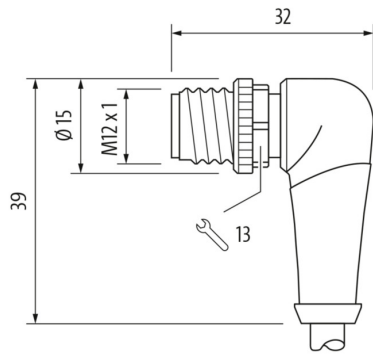

**Side B**

**Technical drawing**

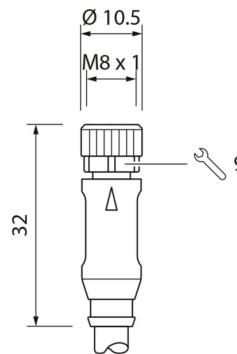

**Coding**

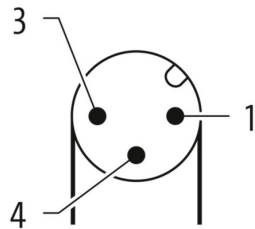

**Coding**

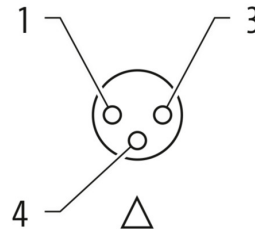

**Connection diagram**

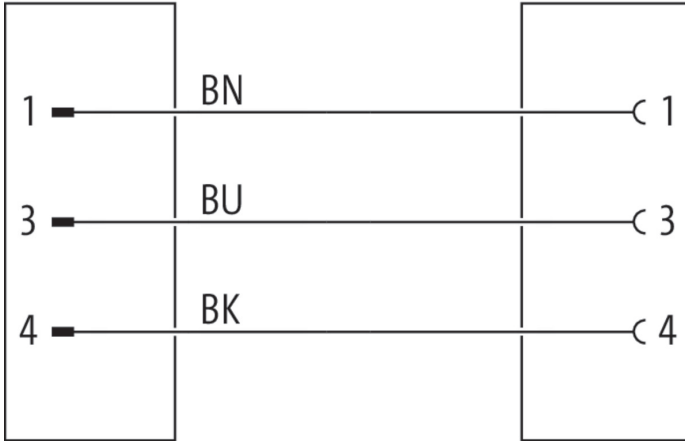

**Dimension drawing**

