

Overview

- M12, male, A-coded, 4-poles; PUR, 2000 cm; M12, female, A-coded, 4-poles
- Dragchain capable; suitable for robotics $\pm 180^\circ/\text{m}$
- Head A: IP65, IP66K, IP67; Head B: IP65, IP66K, IP67
- Cable: good resistance against chemicals, flames, oils
- Halogen free

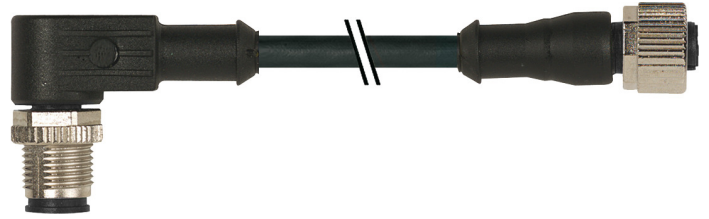

Technical data

Side A		Cable	
Head A: Connection	M12	Cable: Temperature range (mobile)	- 25 ...+ 80 °C
Head A: Angle cable outlet	90°	Cable: Temperature range (fixed)	- 40 ...+ 80 °C
Head A: Gender	Male	Operating voltage (only UL listed)	30 V AC/DC
Head A: Coding	A	Shielded	No
Head A: No. of poles	4	Bending radius (fixed)	22.5 mm
Head A: LED	No	Number of wires	4
Head A: Width across flats	AF13	Number and diameter of wires	4x0.34
Head A: Tightening torque	0.6 Nm	Length tolerance	± 30 cm
Head A: Knurled nut material	Zinc-pressure die casting, surface Ni	Cable length	2000 cm
Head A: Body color	Black	Acceleration (C-track)	max. 10 m/s ²
Labeling sleeve side A	Yes	AWG	22
Side B		Bending radius (fixed)	min. 5 × outer diameter
Head B: Connection	M12	Torsion speed	max. 35 cycles/min
Head B: Angle cable outlet	0°	Bending radius (mobile)	min. 10 × outer diameter
Head B: Gender	Female	Cable type	3
Head B: Coding	A	Cable weight	approx. 36.3 g/m
Head B: No. of poles	4	Conductor structure	42 × 0.1 mm
Head B: LED	No	Cable diameter	4.5 mm $\pm 5\%$
Head B: Width across flats	AF13	Conductor: Material	Copper, bare
Head B: Tightening torque	0.6 Nm	External sheath: Material	PUR
Head B: Knurled nut material	Zinc-pressure die casting, surface Ni	Insulation: Material	PP
Head B: Body color	Black	No. of bending cycles (C-track)	approx. 10000000 Cycles
Head B: Gasket material	FKM	Nominal voltage	300 V
Labeling sleeve side B	Yes	No. of torsion cycles	approx. 2000000 Cycles
Cables		Paired stranding	No
Cable length	2000 cm	Single wire diameter	0.1 mm
Length tolerance	± 30 cm	Cable: Test voltage	2.5 kV
Shielded	No	Torsion stress in °	$\pm 180^\circ/\text{m}$
Conductor structure	42 × 0.1 mm	Total stranding	4 wires strand
AWG	22	Travel speed (C-track)	max. 3 m/s
External sheath: Material	PUR	Traversing path (horizontal)	max. 10 m
External sheath: Color	Black	Wire cross section	0.34 mm ²
Cable diameter	4.5 mm $\pm 5\%$	Wire processing	No
Wire cross section	0.34 mm ²	Wire diameter incl. isolation	1.25 mm $\pm 5\%$
Cable			
External sheath: Shore hardness	90 ± 5 A		

Technical data

Cable

External sheath: Color Black

Electrical data

Operating voltage max. 250 V AC/DC

Operating voltage (only UL listed) 30 V AC/DC

Nominal voltage 300 V

Contact resistance max. 30 mOhm

Operating current per contact max. 4 A

Mechanical data

Head A: Degree of protection IP65, IP66K, IP67

Head B: Degree of protection IP65, IP66K, IP67

Bending radius (mobile) min. 10 × outer diameter

Bending radius (fixed) min. 5 × outer diameter

No. of bending cycles (C-track) approx. 10000000 Cycles

Torsion speed max. 35 cycles/min

Torsion stress in ° ± 180 °/m

No. of torsion cycles approx. 2000000 Cycles

Acceleration (C-track) max. 10 m/s²

Travel speed (C-track) max. 3 m/s

Environmental conditions

Temperature range (mobile) - 25 ...+ 80 °C

Temperature range (fixed) - 25 ...+ 80 °C

Environmental conditions

Cable: Temperature range (fixed) - 40 ...+ 80 °C

Dragchain capable Yes

Head A: Chemical resistance No

Head A: Flame resistance HB (UL 94)

Head A: Oil resistance ASTM 1 oil, mineral oils, limited to hydraulic oils

Head A: Acid and alkali resistant No

Head A: Pollution degree 3

Head B: Chemical resistance No

Head B: Flame resistance HB (UL 94)

Head B: Oil resistance ASTM 1 oil, mineral oils, limited to hydraulic oils

Head B: Acid and alkali resistant No

Head B: Pollution degree 3

Cable: Chemical resistance Good (DIN EN 60811-404)

Cable: Flame resistance Conform UL 1581 §1090 (H), CSA FT2, IEC 60332-2-2

Cable: Oil resistance Good (DIN EN 60811-404)

Cable: Silicone-free Yes

Commercial data

Eclass 27060311

Side A

Technical drawing

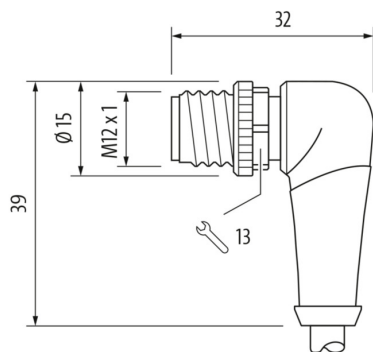

Side A

Coding

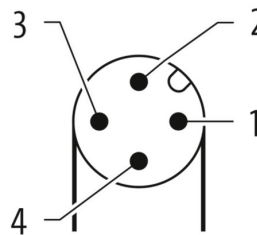

Side B

Technical drawing



Dimension drawing



Coding



Connection diagram

