

Overview

- M12, male, A-coded; 5-poles; TPE-S, 500 cm, free cable end
- Dragchain capable; suitable for robotics $\pm 180^\circ/\text{m}$; suitable for food & beverage
- Head A: IP65, IP68, IP69K
- ECOLAB tested
- Halogen free

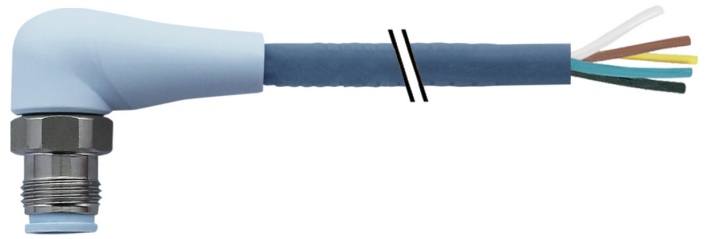

Technical data

Side A

Head A: Connection	M12
Head A: Angle cable outlet	90°
Head A: Gender	Male
Head A: Coding	A
Head A: No. of poles	5
Head A: LED	No
Head A: Width across flats	AF14
Head A: Tightening torque	0.6 Nm
Head A: Knurled nut material	Stainless steel (V4A)
Head A: Body color	Blue
Labeling sleeve side A	No

Side B

Head B: Connection	Open-ended wires
Labeling sleeve side B	No

Cables

Cable length	500 cm
Length tolerance	± 7.5 cm
Stripping length	20 mm
Shielded	No
Conductor structure	42 x 0.1 mm
AWG	22
External sheath: Material	TPE-S
External sheath: Color	Blue
Cable diameter	5 mm $\pm 5\%$
Wire cross section	0.34 mm ²

Cable

Cable: Temperature range (mobile)	- 25 ...+ 105 °C
Cable: Temperature range (fixed)	- 40 ...+ 105 °C
Operating voltage (only UL listed)	30 V AC/DC
Shielded	No
Bending radius (fixed)	25 mm
Number of wires	5
Number and diameter of wires	5x0.34
Length tolerance	± 7.5 cm

Cable

Cable length	500 cm
Acceleration (C-track)	max. 10 m/s ²
AWG	22
Bending radius (fixed)	min. 5 x outer diameter
Torsion speed	max. 35 cycles/min
Bending radius (mobile)	min. 10 x outer diameter
Cable weight	approx. 35.2 g/m
Wire 1: Color	BN
Wire 2: Color	BK
Wire 3: Color	BU
Wire 4: Color	WH
Wire 5: Color	GY
Conductor structure	42 x 0.1 mm
Cable diameter	5 mm $\pm 5\%$
Conductor: Material	Copper, bare
External sheath: Material	TPE-S
Insulation: Material	PP
No. of bending cycles (C-track)	approx. 4000000 Cycles
Nominal voltage	300 V AC
No. of torsion cycles	approx. 2000000 Cycles
Paired stranding	No
Single wire diameter	0.1 mm
Cable: Test voltage	3 kV
Torsion stress in °	$\pm 180^\circ/\text{m}$
Total stranding	5 wires strand around core-filler
Travel speed (C-track)	max. 3 m/s
Traversing path (horizontal)	max. 10 m
Wire cross section	0.34 mm ²
Wire processing	No
Wire diameter incl. isolation	1.27 mm $\pm 5\%$
External sheath: Color	Blue

Electrical data

Operating voltage	max. 125 V AC/DC
Operating voltage (only UL listed)	30 V AC/DC
Nominal voltage	300 V AC
Contact resistance	max. 30 mOhm

Technical data

Electrical data

Operating current per contact max. 4 A

Mechanical data

Head A: Degree of protection IP65, IP68, IP69K

Bending radius (mobile) min. 10 × outer diameter

Bending radius (fixed) min. 5 × outer diameter

No. of bending cycles (C-track) approx. 4000000 Cycles

Torsion speed max. 35 cycles/min

Torsion stress in ° ± 180 °/m

No. of torsion cycles approx. 2000000 Cycles

Acceleration (C-track) max. 10 m/s²

Travel speed (C-track) max. 3 m/s

Environmental conditions

Temperature range (mobile) - 25 ...+ 105 °C

Temperature range (fixed) - 40 ...+ 105 °C

Cable: Temperature range (fixed) - 40 ...+ 105 °C

Environmental conditions

Dragchain capable Yes

Head A: Chemical resistance Chemical resistance tested according to ECOLAB. If other media are used, the material resistance must be tested according to the application.

Head A: Flame resistance HB (UL 94)

Head A: Oil resistance ASTM 1 oil, mineral oils, limited to hydraulic oils

Head A: Acid and alkali resistant ECOLAB tested

Head A: Pollution degree 3

Cable: Chemical resistance ECOLAB material resistance test passed

Cable: Acid and alkali resistant Good (FDA 21 178.3620, 178.3297, 177.1520, EU 10/2011)

Cable: Silicone-free Yes

Commercial data

Eclass 27060311

Side A

Technical drawing

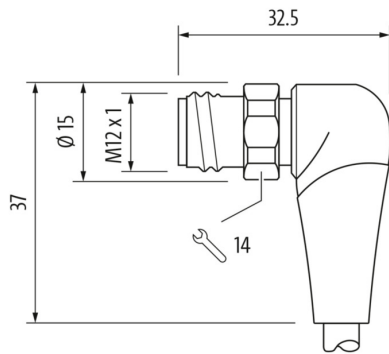

Side A

Coding

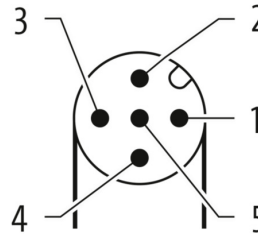

Side B

Technical drawing

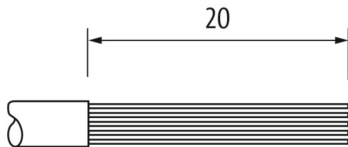

Connection diagram

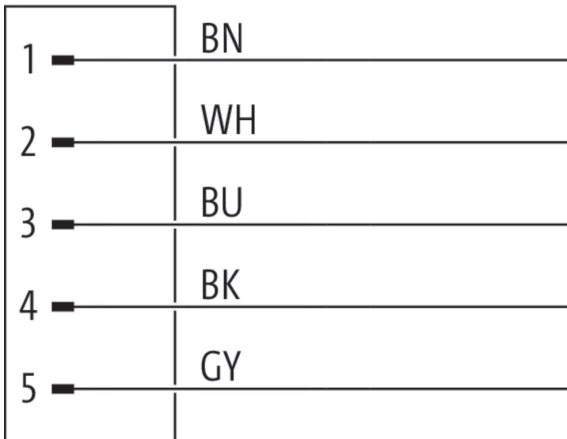

Dimension drawing

