

**Overview**

- M12, male, A-coded; 5-poles; TPE-S, 300 cm, free cable end
- Dragchain capable; suitable for robotics  $\pm 180^\circ/\text{m}$ ; suitable for food & beverage
- Head A: IP65, IP68, IP69K
- ECOLAB tested
- Halogen free

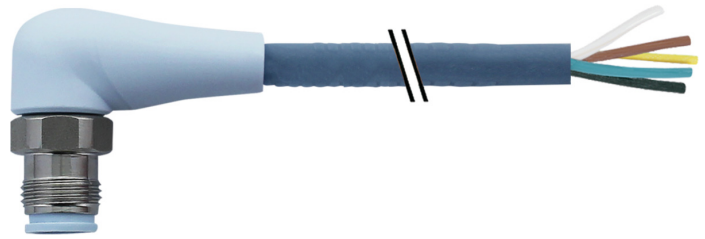

**Technical data**

**Side A**

Head A: Connection	M12
Head A: Angle cable outlet	90°
Head A: Gender	Male
Head A: Coding	A
Head A: No. of poles	5
Head A: LED	No
Head A: Width across flats	AF14
Head A: Tightening torque	0.6 Nm
Head A: Knurled nut material	Stainless steel (V4A)
Head A: Body color	Blue
Labeling sleeve side A	No

**Side B**

Head B: Connection	Open-ended wires
Labeling sleeve side B	No

**Cables**

Cable length	300 cm
Length tolerance	+ 10 cm
Stripping length	20 mm
Shielded	No
Conductor structure	42 × 0.1 mm
AWG	22
External sheath: Material	TPE-S
External sheath: Color	Blue
Cable diameter	5 mm ± 5%
Wire cross section	0.34 mm <sup>2</sup>

**Cable**

Cable: Temperature range (mobile)	- 25 ...+ 105 °C
Cable: Temperature range (fixed)	- 40 ...+ 105 °C
Operating voltage (only UL listed)	30 V AC/DC
Shielded	No
Bending radius (fixed)	25 mm
Number of wires	5
Number and diameter of wires	5x0.34
Length tolerance	+ 10 cm

**Cable**

Cable length	300 cm
Acceleration (C-track)	max. 10 m/s <sup>2</sup>
AWG	22
Bending radius (fixed)	min. 5 × outer diameter
Torsion speed	max. 35 cycles/min
Bending radius (mobile)	min. 10 × outer diameter
Cable weight	approx. 35.2 g/m
Wire 1: Color	BN
Wire 2: Color	BK
Wire 3: Color	BU
Wire 4: Color	WH
Wire 5: Color	GY
Conductor structure	42 × 0.1 mm
Cable diameter	5 mm ± 5%
Conductor: Material	Copper, bare
External sheath: Material	TPE-S
Insulation: Material	PP
No. of bending cycles (C-track)	approx. 4000000 Cycles
Nominal voltage	300 V AC
No. of torsion cycles	approx. 2000000 Cycles
Paired stranding	No
Single wire diameter	0.1 mm
Cable: Test voltage	3 kV
Torsion stress in °	± 180 °/m
Total stranding	5 wires strand around core-filler
Travel speed (C-track)	max. 3 m/s
Traversing path (horizontal)	max. 10 m
Wire cross section	0.34 mm <sup>2</sup>
Wire processing	No
Wire diameter incl. isolation	1.27 mm ± 5%
External sheath: Color	Blue

**Electrical data**

Operating voltage	max. 125 V AC/DC
Operating voltage (only UL listed)	30 V AC/DC
Nominal voltage	300 V AC
Contact resistance	max. 30 mOhm

**Technical data**

**Electrical data**

Operating current per contact max. 4 A

**Mechanical data**

Head A: Degree of protection IP65, IP68, IP69K  
 Bending radius (mobile) min. 10 × outer diameter  
 Bending radius (fixed) min. 5 × outer diameter  
 No. of bending cycles (C-track) approx. 4000000 Cycles  
 Torsion speed max. 35 cycles/min  
 Torsion stress in ° ± 180 °/m  
 No. of torsion cycles approx. 2000000 Cycles  
 Acceleration (C-track) max. 10 m/s<sup>2</sup>  
 Travel speed (C-track) max. 3 m/s

**Environmental conditions**

Temperature range (mobile) - 25 ...+ 105 °C  
 Temperature range (fixed) - 40 ...+ 105 °C  
 Cable: Temperature range (fixed) - 40 ...+ 105 °C

**Environmental conditions**

Dragchain capable Yes  
 Head A: Chemical resistance Chemical resistance tested according to ECOLAB. If other media are used, the material resistance must be tested according to the application.  
 Head A: Flame resistance HB (UL 94)  
 Head A: Oil resistance ASTM 1 oil, mineral oils, limited to hydraulic oils  
 Head A: Acid and alkali resistant ECOLAB tested  
 Head A: Pollution degree 3  
 Cable: Chemical resistance ECOLAB material resistance test passed  
 Cable: Acid and alkali resistant Good (FDA 21 178.3620, 178.3297, 177.1520, EU 10/2011)  
 Cable: Silicone-free Yes

**Commercial data**

Eclass 27060311

**Side A**

**Technical drawing**

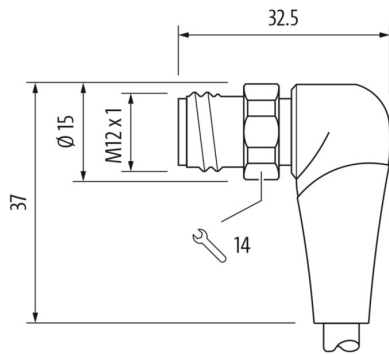

**Side A**

**Coding**

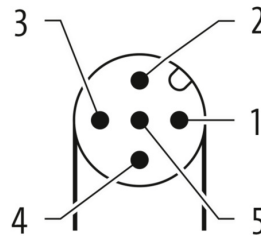

**Side B**

**Technical drawing**

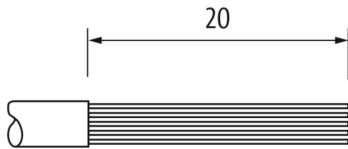

**Connection diagram**

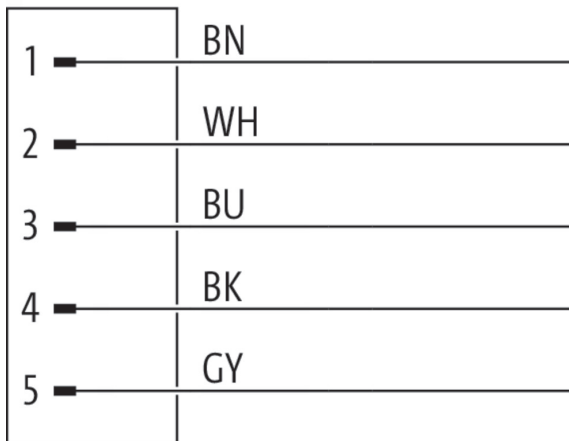

**Dimension drawing**

