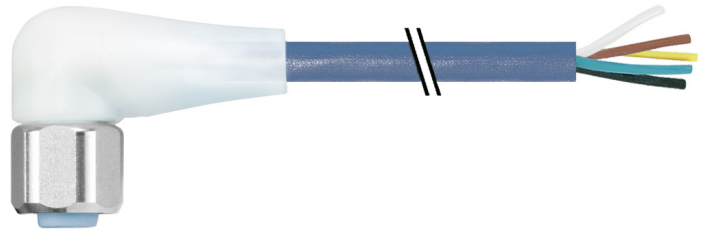

**Overview**

- M12, female, A-coded; 5-poles; TPE-S, 2500 cm, free cable end
- Dragchain capable; suitable for robotics  $\pm 180^\circ/\text{m}$ ; suitable for food & beverage
- Head A: IP65, IP68, IP69K
- ECOLAB tested
- Halogen free

**Technical data**
**Side A**

Head A: Connection	M12
Head A: Angle cable outlet	90°
Head A: Gender	Female
Head A: Coding	A
Head A: No. of poles	5
Head A: LED	Yes
Head A: LED switching status	PNP
Head A: Width across flats	AF14
Head A: Tightening torque	0.6 Nm
Head A: Knurled nut material	Stainless steel (V4A)
Head A: Body color	Transparent
Head A: Gasket material	EPDM
Labeling sleeve side A	No

**Side B**

Head B: Connection	Open-ended wires
Labeling sleeve side B	No

**Cables**

Cable length	2500 cm
Length tolerance	$\pm 37.5$ cm
Stripping length	20 mm
Shielded	No
Conductor structure	42 $\times$ 0.1 mm
AWG	22
External sheath: Material	TPE-S
External sheath: Color	Blue
Cable diameter	5 mm $\pm$ 5%
Wire cross section	0.34 mm <sup>2</sup>

**Cable**

Cable: Temperature range (mobile)	- 25 ...+ 105 °C
Cable: Temperature range (fixed)	- 40 ...+ 105 °C
Shielded	No
Bending radius (fixed)	25 mm
Number of wires	5
Number and diameter of wires	5x0.34
Length tolerance	$\pm 37.5$ cm

**Cable**

Cable length	2500 cm
Acceleration (C-track)	max. 10 m/s <sup>2</sup>
AWG	22
Bending radius (fixed)	min. 5 $\times$ outer diameter
Torsion speed	max. 35 cycles/min
Bending radius (mobile)	min. 10 $\times$ outer diameter
Cable weight	approx. 35.2 g/m
Conductor structure	42 $\times$ 0.1 mm
Cable diameter	5 mm $\pm$ 5%
Conductor: Material	Copper, bare
External sheath: Material	TPE-S
Insulation: Material	PP
No. of bending cycles (C-track)	approx. 4000000 Cycles
Nominal voltage	300 V AC
No. of torsion cycles	approx. 2000000 Cycles
Paired stranding	No
Single wire diameter	0.1 mm
Cable: Test voltage	3 kV
Torsion stress in °	$\pm 180^\circ/\text{m}$
Total stranding	5 wires strand around core-filler
Travel speed (C-track)	max. 3 m/s
Traversing path (horizontal)	max. 10 m
Wire cross section	0.34 mm <sup>2</sup>
Wire processing	No
Wire diameter incl. isolation	1.27 mm $\pm$ 5%
External sheath: Color	Blue

**Electrical data**

Operating voltage	24 V DC $\pm$ 25 %
Nominal voltage	300 V AC
Contact resistance	max. 30 mOhm
Operating current per contact	max. 4 A

**Mechanical data**

Head A: Degree of protection	IP65, IP68, IP69K
Bending radius (mobile)	min. 10 $\times$ outer diameter
Bending radius (fixed)	min. 5 $\times$ outer diameter

**Technical data**

**Mechanical data**

No. of bending cycles (C-track)	approx. 4000000 Cycles
Torsion speed	max. 35 cycles/min
Torsion stress in °	± 180 °/m
No. of torsion cycles	approx. 2000000 Cycles
Acceleration (C-track)	max. 10 m/s <sup>2</sup>
Travel speed (C-track)	max. 3 m/s

**Environmental conditions**

Temperature range (mobile)	- 25 ...+ 85 °C
Temperature range (fixed)	- 40 ...+ 85 °C
Cable: Temperature range (fixed)	- 40 ...+ 105 °C
Dragchain capable	Yes
Head A: Chemical resistance	Chemical resistance tested according to ECOLAB. If other media are used, the material resistance must be tested according to the application.

**Environmental conditions**

Head A: Flame resistance	HB (UL 94)
Head A: Oil resistance	ASTM 1 oil, mineral oils, limited to hydraulic oils
Head A: Acid and alkali resistant	ECOLAB tested
Head A: Pollution degree	3
Cable: Chemical resistance	ECOLAB material resistance test passed
Cable: Acid and alkali resistant	Good (FDA 21 178.3620, 178.3297, 177.1520, EU 10/2011)
Cable: Silicone-free	Yes

**Commercial data**

Eclass	27060311
--------	----------

**Side A**

**Technical drawing**

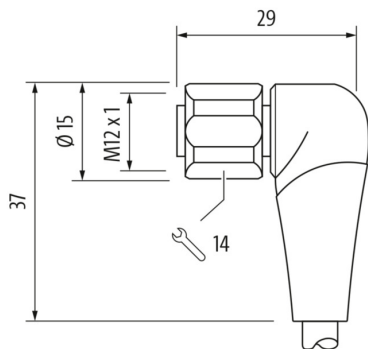

**Side B**

**Technical drawing**

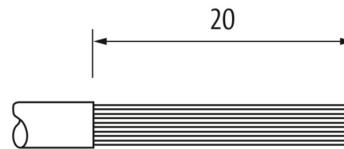

**Coding**

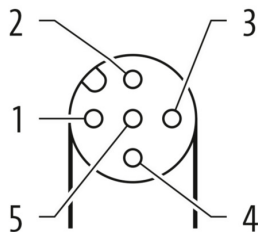

**Connection diagram**

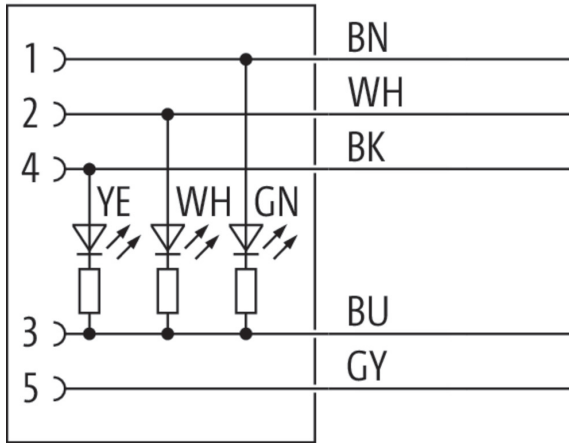

**Dimension drawing**

