

Overview

- M12, female, A-coded; 5-poles; TPE-S, 2500 cm, shielded, free cable end
- Dragchain capable; suitable for robotics $\pm 180^\circ/\text{m}$; suitable for food & beverage
- Head A: IP65, IP68, IP69K
- ECOLAB tested
- Halogen free

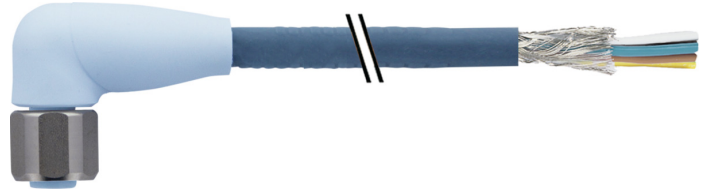

Technical data

Side A		Cable	
Head A: Connection	M12	Number and diameter of wires	5x0.34
Head A: Angle cable outlet	90°	Length tolerance	± 37.5 cm
Head A: Gender	Female	Cable length	2500 cm
Head A: Coding	A	Acceleration (C-track)	max. 10 m/s ²
Head A: No. of poles	5	AWG	22
Head A: LED	No	Bending radius (fixed)	min. 5 × outer diameter
Head A: Width across flats	AF14	Torsion speed	max. 35 cycles/min
Head A: Tightening torque	0.6 Nm	Bending radius (mobile)	min. 10 × outer diameter
Head A: Knurled nut material	Stainless steel (V4A)	Cable weight	approx. 51.7 g/m
Head A: Body color	Blue	Conductor structure	42 × 0.1 mm
Head A: Gasket material	EPDM	Cable diameter	5.9 mm $\pm 5\%$
Labeling sleeve side A	No	Conductor: Material	Copper, bare
Side B		External sheath: Material	TPE-S
Head B: Connection	Open-ended wires	Insulation: Material	PP
Labeling sleeve side B	No	Shielding: Material	Copper, tinned
Cables		No. of bending cycles (C-track)	approx. 4000000 Cycles
Cable length	2500 cm	Nominal voltage	300 V AC
Length tolerance	± 37.5 cm	No. of torsion cycles	approx. 2000000 Cycles
Stripping length	20 mm	Paired stranding	No
Shielded	Yes	Single wire diameter	0.1 mm
Conductor structure	42 × 0.1 mm	Cable: Test voltage	3 kV
AWG	22	Torsion stress in °	$\pm 180^\circ/\text{m}$
External sheath: Material	TPE-S	Total stranding	5 wires strand around core-filler
External sheath: Color	Blue	Travel speed (C-track)	max. 3 m/s
Cable diameter	5.9 mm $\pm 5\%$	Traversing path (horizontal)	max. 10 m
Wire cross section	0.34 mm ²	Wire cross section	0.34 mm ²
Cable		Wire processing	No
Cable: Temperature range (mobile)	- 25 ...+ 105 °C	Wire diameter incl. isolation	1.27 mm $\pm 5\%$
Cable: Temperature range (fixed)	- 40 ...+ 105 °C	External sheath: Color	Blue
Operating voltage (only UL listed)	30 V AC/DC	Electrical data	
Shielded	Yes	Operating voltage	max. 60 V AC/DC
Shielding: Covering	approx. 85 %	Operating voltage (only UL listed)	30 V AC/DC
Bending radius (fixed)	29.5 mm	Nominal voltage	300 V AC
Number of wires	5	Contact resistance	max. 30 mOhm

The product features and technical data specified do not express or imply any warranty. Technical modifications subject to change. 2024-05-22

Technical data

Electrical data

Operating current per contact max. 4 A

Mechanical data

Head A: Degree of protection IP65, IP68, IP69K
 Bending radius (mobile) min. 10 × outer diameter
 Bending radius (fixed) min. 5 × outer diameter
 No. of bending cycles (C-track) approx. 4000000 Cycles
 Torsion speed max. 35 cycles/min
 Torsion stress in ° ± 180 °/m
 No. of torsion cycles approx. 2000000 Cycles
 Acceleration (C-track) max. 10 m/s²
 Travel speed (C-track) max. 3 m/s

Environmental conditions

Temperature range (mobile) - 25 ...+ 105 °C
 Temperature range (fixed) - 40 ...+ 105 °C
 Cable: Temperature range (fixed) - 40 ...+ 105 °C

Environmental conditions

Dragchain capable Yes
 Head A: Chemical resistance Chemical resistance tested according to ECOLAB. If other media are used, the material resistance must be tested according to the application.
 Head A: Flame resistance HB (UL 94)
 Head A: Oil resistance ASTM 1 oil, mineral oils, limited to hydraulic oils
 Head A: Acid and alkali resistant ECOLAB tested
 Head A: Pollution degree 3
 Cable: Chemical resistance ECOLAB material resistance test passed
 Cable: Acid and alkali resistant Good (FDA 21 178.3620, 178.3297, 177.1520, EU 10/2011)
 Cable: Silicone-free Yes

Commercial data

Eclass 27060311

Side A

Coding

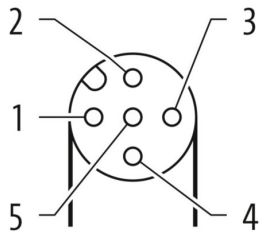

Side B

Technical drawing

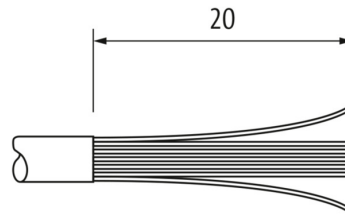

Connection diagram

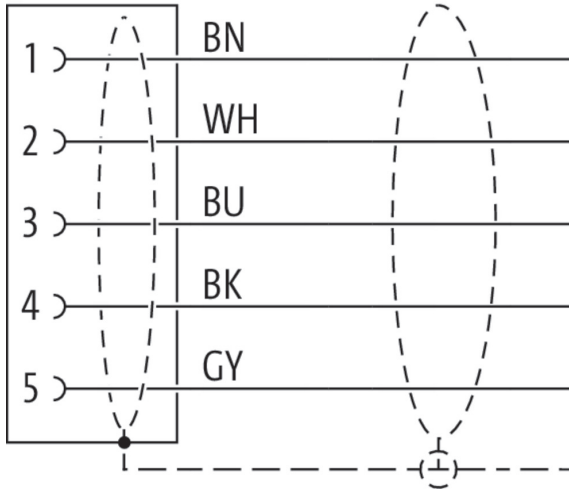

Dimension drawing

