

Overview

- M12, female, A-coded, 8-poles; PUR, 500 cm, shielded, free cable end
- Dragchain capable
- Head A: IP65, IP66K, IP67
- Cable: good resistance against chemicals, flames, oils
- Halogen free



Technical data

Side A

Head A: Connection	M12
Head A: Angle cable outlet	0°
Head A: Gender	Female
Head A: Coding	A
Head A: No. of poles	8
Head A: LED	No
Head A: Width across flats	AF13
Head A: Tightening torque	0.6 Nm
Head A: Knurled nut material	Zinc-pressure die casting, surface Ni
Head A: Body color	Black
Head A: Gasket material	FKM
Labeling sleeve side A	Yes

Side B

Head B: Connection	Open-ended wires
Labeling sleeve side B	Yes

Cables

Cable length	500 cm
Length tolerance	± 7.5 cm
Stripping length	60 mm
Shielded	Yes
Conductor structure	32 × 0.1 mm
AWG	24
External sheath: Material	PUR
External sheath: Color	Black
Cable diameter	7 mm ± 5%
Wire cross section	0.25 mm ²

Cable

Cable: Temperature range (mobile)	- 25 ...+ 80 °C
Cable: Temperature range (fixed)	- 40 ...+ 80 °C
Operating voltage (only UL listed)	30 V AC/DC
Shielded	Yes
Shielding: Covering	approx. 80 %
Bending radius (fixed)	35 mm
Number of wires	8

Cable

Number and diameter of wires	8x0.25
Length tolerance	± 7.5 cm
Cable length	500 cm
Acceleration (C-track)	max. 5 m/s ²
AWG	24
Bending radius (fixed)	min. 5 × outer diameter
Torsion speed	max. 35 cycles/min
Bending radius (mobile)	min. 10 × outer diameter
Cable type	3
Cable weight	approx. 66 g/m
Conductor structure	32 × 0.1 mm
Cable diameter	7 mm ± 5%
Conductor: Material	Copper, bare
External sheath: Material	PUR
Insulation: Material	PP
Shielding: Material	Copper, tinned
No. of bending cycles (C-track)	approx. 500000 Cycles
Nominal voltage	300 V
No. of torsion cycles	approx. 2000000 Cycles
Paired stranding	No
Single wire diameter	0.1 mm
Cable: Test voltage	2 kV AC core-core ; 2 kV AC core-shield
Torsion stress in °	± 30 °/m
Total stranding	8 wires strand around core-filler
Travel speed (C-track)	max. 3.3 m/s
Traversing path (horizontal)	max. 5 m
Wire cross section	0.25 mm ²
Wire processing	No
Wire diameter incl. isolation	1.2 mm ± 5%
External sheath: Color	Black

Electrical data

Operating voltage	max. 30 V AC/DC
Operating voltage (only UL listed)	30 V AC/DC
Nominal voltage	300 V
Contact resistance	max. 30 mOhm

Technical data

Electrical data

Operating current per contact max. 2 A

Mechanical data

Head A: Degree of protection IP65, IP66K, IP67
 Bending radius (mobile) min. 10 × outer diameter
 Bending radius (fixed) min. 5 × outer diameter
 No. of bending cycles (C-track) approx. 5000000 Cycles
 Torsion speed max. 35 cycles/min
 Torsion stress in ° ± 30 °/m
 No. of torsion cycles approx. 2000000 Cycles
 Acceleration (C-track) max. 5 m/s²
 Travel speed (C-track) max. 3.3 m/s

Environmental conditions

Temperature range (mobile) - 25 ...+ 80 °C
 Temperature range (fixed) - 25 ...+ 80 °C

Environmental conditions

Cable: Temperature range (fixed) - 40 ...+ 80 °C
 Dragchain capable Yes
 Head A: Chemical resistance No
 Head A: Flame resistance HB (UL 94)
 Head A: Oil resistance ASTM 1 oil, mineral oils, limited to hydraulic oils
 Head A: Acid and alkali resistant No
 Head A: Pollution degree 3
 Cable: Chemical resistance Good (DIN EN 60811-404)
 Cable: Flame resistance Conform UL 1581 §1090 (H), CSA FT2, IEC 60332-2-2
 Cable: Oil resistance Good (DIN EN 60811-404)
 Cable: Silicone-free Yes

Commercial data

Eclass 27060311

Side A

Technical drawing



Side B

Technical drawing

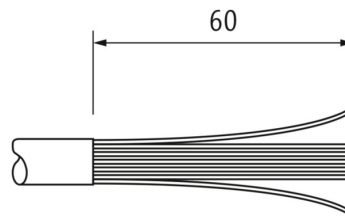

Coding

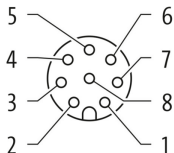

Connection diagram

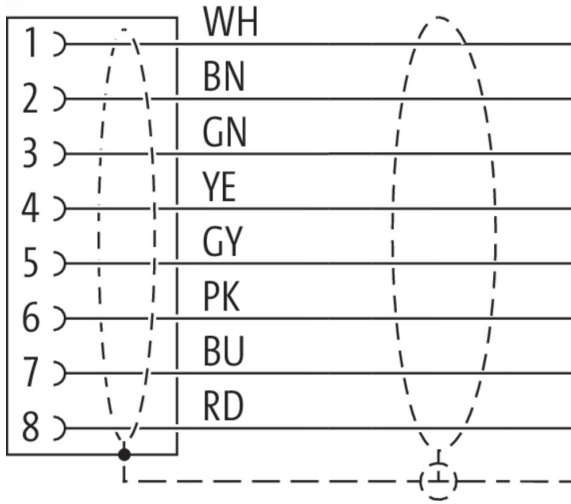

Dimension drawing

