

Overview

- M12, male, D-coded, 4-poles; PUR, 2000 cm, shielded; RJ45, male, D-coded, 4-poles
- Dragchain capable, CAT5, 100 Mbit/s
- Head A: IP67; Head B: IP20
- Cable: good resistance against flames, oils
- Halogen free

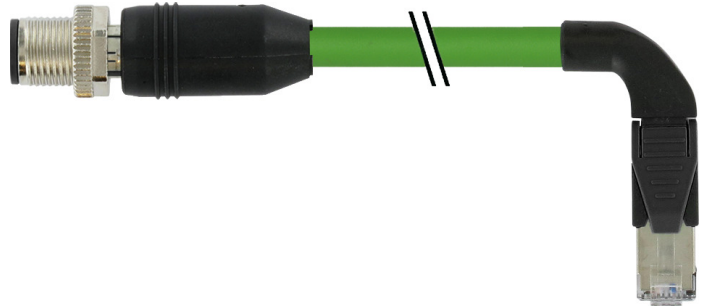

Technical data

Side A

Head A: Connection	M12
Head A: Angle cable outlet	0°
Head A: Gender	Male
Head A: Coding	D
Head A: No. of poles	4
Head A: LED	No
Head A: Width across flats	AF13
Head A: Tightening torque	0.6 Nm
Head A: Knurled nut material	Zinc-pressure die casting, surface Ni
Head A: Body color	Black
Labeling sleeve side A	Yes

Side B

Head B: Connection	RJ45
Head B: Angle cable outlet	90°
Head B: Gender	Male
Head B: No. of poles	4
Head B: LED	No
Head B: Body color	Black
Labeling sleeve side B	Yes

Cables

Cable length	2000 cm
Length tolerance	± 30 cm
Shielded	Yes
Conductor structure	7 × 0.254 mm
AWG	22
External sheath: Material	PUR
External sheath: Color	Green
Cable diameter	6.7 mm ± 5%
Wire cross section	0.355 mm ²

Cable

Cable: Temperature range (mobile)	- 30 ...+ 70 °C
Cable: Temperature range (fixed)	- 40 ...+ 80 °C
Shielded	Yes
Shielding: Covering	approx. 85 %

Cable

Characteristic impedance	100 Ohm ± 15%
Signal delay	5.1 ns/m
Transmission rate	100 MBit/s
Bending radius (fixed)	33.5 mm
Number of wires	4
Number and diameter of wires	4x0.355
Length tolerance	± 30 cm
Cable length	2000 cm
Acceleration (C-track)	max. 2 m/s ²
AWG	22
Bending radius (fixed)	min. 5 × outer diameter
Bending radius (mobile)	min. 12 × outer diameter
Cable weight	approx. 69.3 g/m
Wire 1: Color	WH
Wire 2: Color	YE
Wire 3: Color	BU
Wire 4: Color	OG
Conductor structure	7 × 0.254 mm
Cable diameter	6.7 mm ± 5%
Insulation resistance	min. 5 MOhm x m
Conductor: Material	Copper, bare
External sheath: Material	PUR
Insulation: Material	PE
Shielding: Material	Copper, tinned; PET aluminium coated
No. of bending cycles (C-track)	approx. 3000000 Cycles
Nominal voltage	300 V
Paired stranding	No
Single wire diameter	0.254 mm
Cable: Test voltage	2 kV AC core-core ; 2 kV AC core-shield
Total stranding	4 wires strand around core-filler
Travel speed (C-track)	max. 3.3 m/s
Traversing path (horizontal)	max. 5 m
Wire cross section	0.355 mm ²
Wire processing	No
Wire diameter incl. isolation	1.4 mm ± 5%

Technical data

Cable

External sheath: Color	Green
Protocols	CAT5e

Electrical data

Operating voltage	max. 60 V DC
Nominal voltage	300 V
Contact resistance	max. 30 mOhm
Operating current per contact	max. 1.5 A

Mechanical data

Head A: Degree of protection	IP67
Head B: Degree of protection	IP20
Bending radius (mobile)	min. 12 × outer diameter
Bending radius (fixed)	min. 5 × outer diameter
No. of bending cycles (C-track)	approx. 3000000 Cycles
Acceleration (C-track)	max. 2 m/s ²
Travel speed (C-track)	max. 3.3 m/s

Environmental conditions

Temperature range (mobile)	- 25 ... + 70 °C
Temperature range (fixed)	- 25 ... + 80 °C
Cable: Temperature range (fixed)	- 40 ... + 80 °C

Environmental conditions

Dragchain capable	Yes
Head A: Chemical resistance	No
Head A: Flame resistance	HB (UL 94)
Head A: Oil resistance	ASTM 1 oil, mineral oils, limited to hydraulic oils
Head A: Acid and alkali resistant	No
Head A: Pollution degree	3
Head B: Chemical resistance	No
Head B: Flame resistance	HB (UL 94)
Head B: Oil resistance	ASTM 1 oil, mineral oils, limited to hydraulic oils
Head B: Acid and alkali resistant	No
Head B: Pollution degree	3
Cable: Flame resistance	Conform UL 1581 §1090, §1100 (FT2), IEC 60332-1-2 Std.
Cable: Oil resistance	Conform IEC 60811-2-1, ASTM IRM 901, ICEA S-82-552 Std.
Cable: Silicone-free	Yes

Commercial data

Eclass	27061801
--------	----------

Side A

Technical drawing

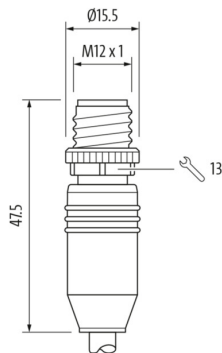

Side A

Coding

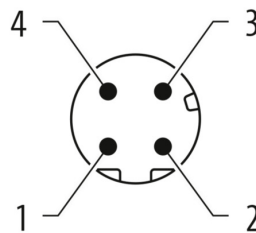

Side B

Technical drawing

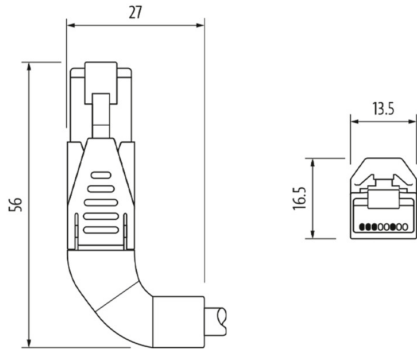

Dimension drawing



Coding



Connection diagram

