

Overview

- M12, male, L-coded, 5-poles; PUR, 2500 cm; M12, female, L-coded, 5-poles
- Dragchain capable; suitable for robotics ± 180 °/m
- Head A: IP65, IP67; Head B: IP65, IP67
- Cable: good resistance against chemicals, flames, oils
- Halogen free

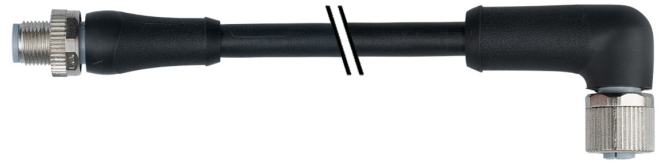

Technical data

Side A

Head A: Connection	M12
Head A: Angle cable outlet	0°
Head A: Gender	Male
Head A: Coding	L
Head A: No. of poles	5
Head A: LED	No
Head A: Width across flats	AF17
Head A: Tightening torque	0.6 Nm
Head A: Knurled nut material	Zinc-pressure die casting, surface Ni
Head A: Body color	Black
Labeling sleeve side A	Yes

Side B

Head B: Connection	M12
Head B: Angle cable outlet	90°
Head B: Gender	Female
Head B: Coding	L
Head B: No. of poles	5
Head B: LED	No
Head B: Width across flats	AF17
Head B: Tightening torque	0.6 Nm
Head B: Knurled nut material	Zinc-pressure die casting, surface Ni
Head B: Body color	Black
Head B: Gasket material	FKM
Labeling sleeve side B	Yes

Cables

Cable length	2500 cm
Length tolerance	± 37.5 cm
Shielded	No
Conductor structure	84 \times 0.15 mm
AWG	16
External sheath: Material	PUR
External sheath: Color	Black
Cable diameter	8.7 mm \pm 5%
Wire cross section	1.5 mm ²

Electrical data

Operating voltage	max. 63 V DC
Nominal voltage	1000 V AC

Electrical data

Contact resistance	max. 30 mOhm
Operating current per contact	max. 12 A

Mechanical data

Head A: Degree of protection	IP65, IP67
Head B: Degree of protection	IP65, IP67
Bending radius (mobile)	min. 10 \times outer diameter
Bending radius (fixed)	min. 7.5 \times outer diameter
No. of bending cycles (C-track)	approx. 5000000 Cycles
Torsion speed	max. 35 cycles/min
Torsion stress in °	± 180 °/m
No. of torsion cycles	approx. 2000000 Cycles
Acceleration (C-track)	max. 5 m/s ²
Travel speed (C-track)	max. 3.3 m/s

Environmental conditions

Temperature range (mobile)	- 20 ...+ 80 °C
Temperature range (fixed)	- 25 ...+ 80 °C
Cable: Temperature range (fixed)	- 50 ...+ 80 °C
Dragchain capable	Yes
Head A: Chemical resistance	No
Head A: Flame resistance	V-2 (UL 94)
Head A: Acid and alkali resistant	No
Head A: Pollution degree	3
Head B: Chemical resistance	No
Head B: Flame resistance	V-2 (UL 94)
Head B: Acid and alkali resistant	No
Head B: Pollution degree	3
Cable: Chemical resistance	Good (DIN EN 60811-404)
Cable: Flame resistance	Conform UL 1581 VW-1, CSA FT1, IEC 60332-1, IEC 60332-2-2
Cable: Oil resistance	Good (DIN EN 60811-404)
Cable: Silicone-free	Yes

Technical data

Commercial data

Eclass 27060311

Side A

Technical drawing

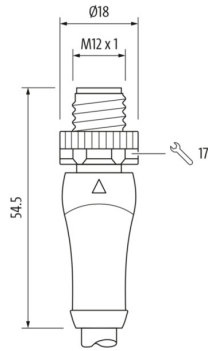

Side B

Technical drawing

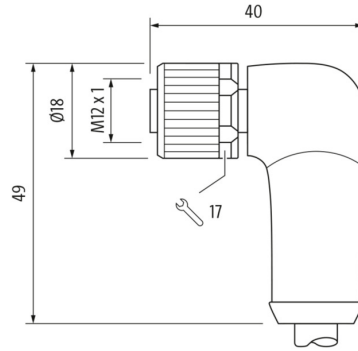

Coding

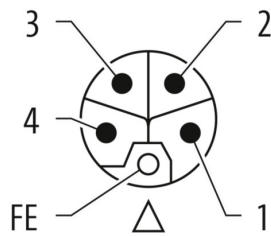

Coding

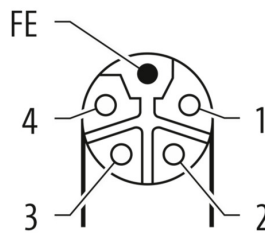

Connection diagram



Dimension drawing

