

产品一览

- 压向力测量范围：0...200 N
- 线性误差 < 0.2 %
- 传感器主体采用不锈钢制成，防护等级达IP68
- 全焊接设计
- 抗疲劳强度高，可承受相对振幅为100%的动态载荷



技术数据

基本参数

Measuring range	0 ... 200 N
Non-linearity	< 0,2 %
Repeatability	< 0,1 %
Temperature effect zero	< 0,2 % / 10K
Zero point deviation	< 20 %
Type	按钮式
Mechanical mounting	4 x M3 螺钉 / 不紧固

机械参数

Overload	150 %
Breaking load	200 %
Fatigue strength	> 1000万次 · 范围0...100% FS
Nominal displacement	18 µm
Weight	65 g
Material sensor body	不锈钢1.4542

机械参数

Electrical connection	M8 · 4针 · 公头
-----------------------	--------------

电气参数

Nominal sensitivity	1 mV/V
Bridge resistance	1000 Ω
Supply voltage	0,5 ... 12 VDC
Signal polarity positive	压向力

环境条件

Operating temperature range	-40 ... 85 °C
Storage temperature range	-40 ... 85 °C

Protection class EN 60529, ISO20653	IP 68
-------------------------------------	-------

认证和标准

UL listed	E217824
-----------	---------

尺寸图 (mm)

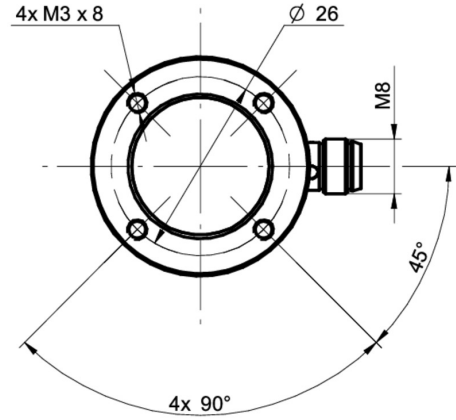
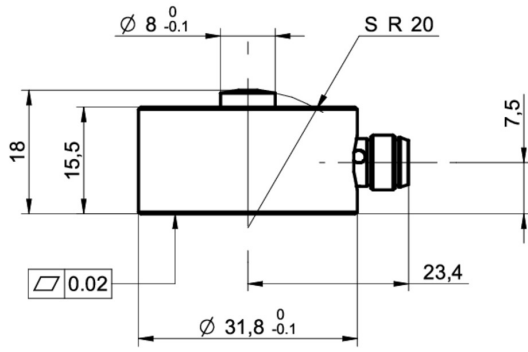

电气连接

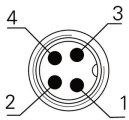

- 1 +Vs
- 2 Sig +
- 3 -Vs
- 4 Sig -