

EAL580-SC0.5WEC.13160.A

Solid shaft with clamping flange, optical multiturn encoders 13 bit ST / 16 bit MT, EtherCAT

Article number: 11200300

Overview

- Absolute encoder multiturn
- Optical sensing method
- Resolution: singleturn 13 bit, multiturn 16 bit
- Clamping flange
- LED status display
- EtherCAT
- Maximum resistant against magnetic fields



Technical data

Technical data - electrical ratings

Voltage supply	10...30 VDC
Reverse polarity protection	Yes
Consumption w/o load	≤100 mA (24 VDC)
Interface	EtherCAT
Function	Multiturn
Steps per revolution	8192 / 13 bit
Number of revolutions	65536 / 16 bit
Total resolution	29 bit
Absolute accuracy	±0.01 ° (ST 18 bit / MT 13 bit) ±0.025 ° (ST 13 bit / MT 16 bit)
Sensing method	Optical
Interference immunity	EN 61000-6-2
Emitted interference	EN 61000-6-4
Status indicator	4x LED integrated in housing
Approval	UL approval / E63076

Technical data - mechanical design

Size (flange)	ø58 mm
---------------	--------

Technical data - mechanical design

Shaft type	ø10 x 20 mm, solid shaft with flat
Protection EN 60529	IP 65
Operating speed	≤10000 rpm (mechanical) ≤6000 rpm (electric)
Starting acceleration	≤1000 U/s ²
Starting torque	≤0.03 Nm (+25 °C, IP 65)
Rotor moment of inertia	20 gcm ²
Material	Housing: zinc diecast Flange: aluminium
Operating temperature	-40...+85 °C (see general information)
Relative humidity	95 % non-condensing
Resistance	EN 60068-2-6 Vibration ±0.75 mm - 10-58 Hz, 10 g - 58-2000 Hz EN 60068-2-27 Shock 100 g, 2 ms
Weight approx.	500 g
Connection	Flange connector 3xM12

EAL580-SC0.5WEC.13160.A

Solid shaft with clamping flange, optical multiturn encoders 13 bit ST / 16 bit MT, EtherCAT

Article number: 11200300

General information

Self-heating interrelated to speed, protection, attachment method and ambient conditions as well electronics and supply voltage must be considered for precise thermal dimensioning. Self-heating is supposed to approximate 4 K (IP 54 protection) respectively 6 K (IP 65 / IP 67 protection) per 1000 rpm. Operating the encoder close to the maximum limits requires measuring the real prevailing temperature at the encoder flange.

Terminal assignment

Voltage supply

Pin	Assigned	Significance
1	UB	Voltage supply
2	d.u.	Do not connect
3	GND	Ground
4	d.u.	Do not connect



1 x flange connector M12 (male), A-coded

EtherCAT (data line)

Pin	Assigned	Significance
1	TxD+	Transmission data+
2	RxD+	Receiving data+
3	TxD-	Transmission data-
4	RxD-	Receiving data-



2 x flange connector M12 (female), D-coded

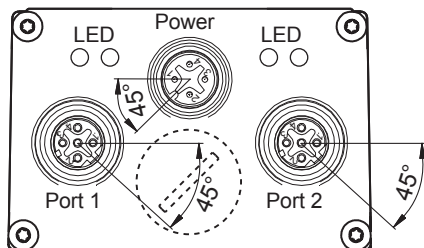

EtherCAT features

Bus protocol	EtherCAT
Device profile	Encoder-Profil CANopen® CiA 406 Vers. 4.0.2 from 18.08.2016
Operating modes	Free Run, Synchronous with SM3 Event, DC Mode (Distributed Clocks)
Cycle time	Min. 62.5 µs
Features	<ul style="list-style-type: none"> - Gear factor (round shaft) and endless loop mode - Time stamp (time of position data acquisition) - Plausibility check of the configurable parameters - Comprehensive diagnostic functions - Preset button for position - File Access over EtherCAT (FoE)
Process data	<ul style="list-style-type: none"> - Position value 32 bits input data with/without speed 32 bits - Extensive process data mapping
LED status indicator	2x Link/Activity, RUN, ERR

EAL580-SC0.5WEC.13160.A

Solid shaft with clamping flange, optical multiturn encoders 13 bit ST / 16 bit MT, EtherCAT

Article number: 11200300

Dimensions

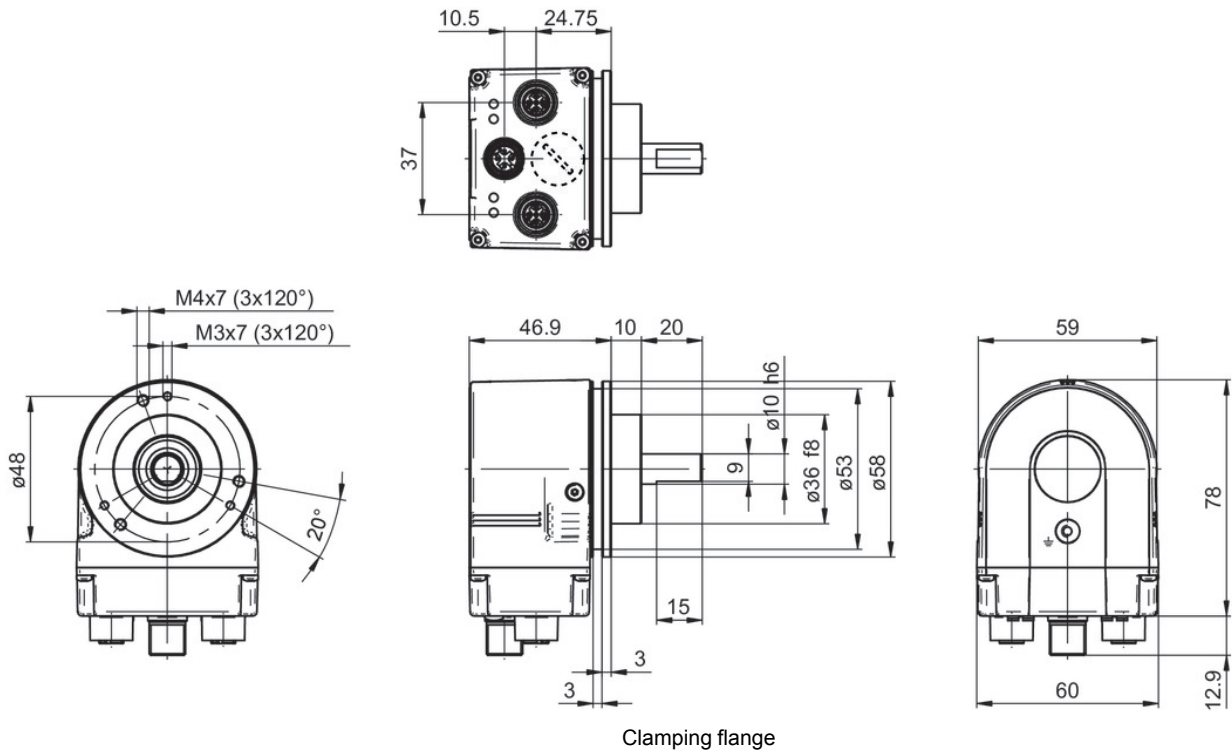

Accessories**Mounting accessories**

11101781	Double loops coupling (D1=10 / D2=10)
11050507	Bellows coupling (D1=06 / D2=10)
11065923	Coupling CPS25 (L=19, D1=10 / D2=10)
11065922	Coupling CPS25 (L=19, D1=10 / D2=06)
10141132	Spring washer coupling (D1=6 / D2=10)
10141133	Spring washer coupling (D1=10 / D2=10)
11069337	Coupling CPS37 (L=24, D1=10 / D2=06)
11069340	Coupling CPS37 (L=24, D1=10 / D2=10)
11053277	Bellows coupling (D1=10 / D2=10)
11101893	Spring encoder arm
11177167	Self-tapping grounding screw (Z 119.100)
11065545	Set of eccentric fixings type A