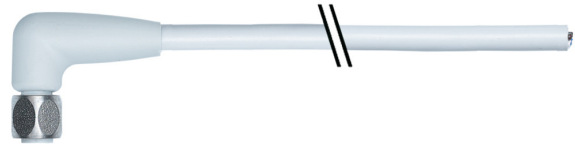

**Overview**

- M8, female, A-coded; 4-poles; TPE, 500 cm, free cable end
- Dragchain capable, suitable for robotics, suitable for food & beverage
- Head A: IP65, IP66K, IP67, IP69
- Cable: Good resistance against chemicals, flames and oils
- Halogen free

**Technical data**
**Side A**

Head A: Connection	M8
Head A: Angle cable outlet	90°
Head A: Gender	Female
Head A: Coding	A
Head A: No. of poles	4
Head A: Tightening torque	0.6 Nm
Head A: Knurled nut material	Stainless steel (V4A)
Head A: Gasket material	EPDM

**Side B**

Head B: Connection	Open-ended wires
--------------------	------------------

**Cables**

Cable length	500 cm
Stripping length	0 mm
Conductor structure	42 × 0.1 mm
AWG	22
External sheath: Material	TPE
External sheath: Color	Gray
Cable diameter	4.6 mm ± 5%
Wire cross section	0.34 mm <sup>2</sup>

**Electrical data**

Operating voltage	240 V
-------------------	-------

**Electrical data**

Nominal voltage	240 V
Contact resistance	≤ 5 mOhm
Operating current per contact	max. 4 A

**Mechanical data**

Head A: Degree of protection	IP65, IP67, IP68, IP69
Bending radius (mobile)	min. 10 × outer diameter
Bending radius (fixed)	min. 5 × outer diameter
No. of bending cycles (C-track)	≥ 4000000 Cycles
Acceleration (C-track)	≤ 10 m/s <sup>2</sup>
Travel speed (C-track)	≤ 3 m/s

**Environmental conditions**

Temperature range (mobile)	- 25 ...+ 105 °C
Temperature range (fixed)	- 40 ...+ 105 °C
Cable: Temperature range (fixed)	- 25 ...+ 105 °C
Dragchain capable	Yes
Head A: Pollution degree	3
Cable: Chemical resistance	Good

**Side A**

**Technical drawing**

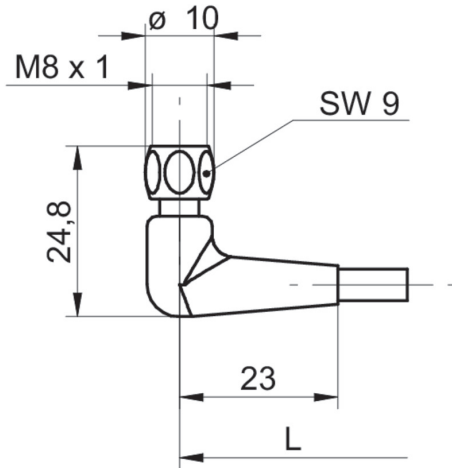

**Connection diagram**

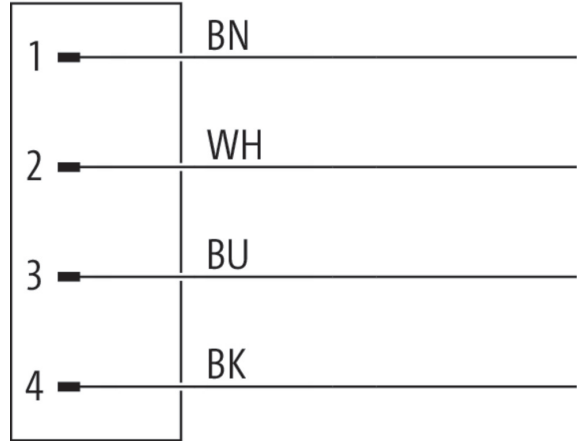

**Coding**

