

HMG10-T - DeviceNet

Through hollow shaft

DeviceNet / 13 bit ST / 16 bit MT / Speed switch

Overview

- Interface DeviceNet
- Magnetic sensing method
- Resolution: singleturn 13 bit, multiturn 16 bit
- Function display via LEDs
- Multiturn sensing with Energy Harvesting technology "MicroGen", without gear or battery
- Two-sided bearing system with hybrid bearings
- Special protection against corrosion CX (C5-M)



Picture similar

HUBNER
BERLIN
A Baumer Brand

microGen
Energy Harvesting

Technical data

Technical data - electrical ratings

Voltage supply	10...30 VDC
Short-circuit proof	Yes
Consumption w/o load	≤200 mA
Initializing time	≤ 500 ms after power on
Interface	DeviceNet
Function	Multiturn
Transmission rate	125 ... 500 kBaud
Device address	Rotary switches in bus connecting box
Steps per revolution	8192 / 13 bit
Number of revolutions	65536 / 16 bit
Additional outputs	Square-wave TTL/HTL, TTL/RS422
Sensing method	Magnetic
Interference immunity	EN 61000-6-2
Emitted interference	EN 61000-6-3
Programmable parameters	Steps per revolution Number of revolutions Preset, scaling, rotating direction
Diagnostic function	Position or parameter error
Status indicator	DUO-LED (bus connecting box) 4 LEDs in device back side
Approval	CE UL approval / E217823 EAC

Technical data - electrical ratings (speed switch)

Switching accuracy	± 2 % (or 1 Digit)
Switching outputs	1 output (Open collector, solid state relay on request)

Technical data - electrical ratings (speed switch)

Output switching capacity	30 VDC; ≤100 mA
Switching delay time	≤20 ms
Technical data - mechanical design	
Size (flange)	ø105 mm
Shaft type	ø16...20 mm (through hollow shaft)
Flange	Support plate, 360° freely positionable
Protection EN 60529	IP 66/IP 67
Operating speed	≤6000 rpm
Range of switching speed	ns (off) = ±2...6000 rpm
Operating torque typ.	10 Ncm
Rotor moment of inertia	950 gcm ²
Admitted shaft load	≤450 N axial ≤650 N radial
Material	Housing: aluminium alloy Shaft: stainless steel
Corrosion protection	IEC 60068-2-52 Salt mist for ambient conditions CX (C5-M) according to ISO 12944-2
Operating temperature	-40...+85 °C
Relative humidity	95 % non-condensing
Resistance	IEC 60068-2-6 Vibration 30 g, 10-2000 Hz IEC 60068-2-27 Shock 400 g, 1 ms
Weight approx.	2.2 kg (depending on version)
Connection	Bus connecting box Terminal box incremental

Optional

- Integrated speed switch
- Additional output incremental with zero pulse

HMG10-T - DeviceNet

Through hollow shaft

DeviceNet / 13 bit ST / 16 bit MT / Speed switch

Terminal assignment

DeviceNet - View A (see dimension)

View inside bus connecting box DeviceNet

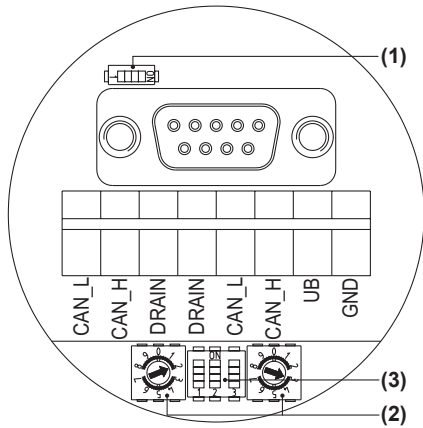

Terminals of the same significance are internally connected and identical in their functions. Max. load on the internal terminal connections UB-UB and GND-GND is 1 A each.

Terminating resistor (1)

ON = Last user

OFF = User x

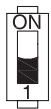

User address (2)

Defined by rotary switch.

Example: User address 23

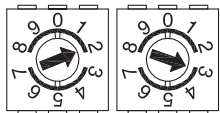

DeviceNet - Transmission rate (3)

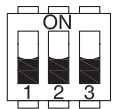

Transmission rate	Setting DIP switches		
	1	2	3
125 kBaud*	X	OFF	OFF
250 kBaud	X	OFF	ON
500 kBaud	X	ON	OFF
125 kBaud	X	ON	ON

X = Without function

* Factory setting

Terminal assignment

View A1 and A2 (see dimension)

View into connector DeviceNet

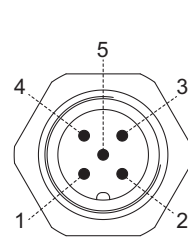

Connector M12 (male, A1)
5-pin, A-coded

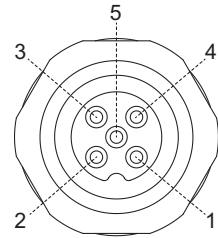

Connector M12 (female, A2)
5-pin, A-coded

Pin	Connection
1	DRAIN
2	UB
3	GND
4	CAN_H
5	CAN_L

Terminals of the same significance are internally connected and identical in their functions. Max. load on the internal terminal connections GND-GND is 1 A each.

View B (see dimension)

Connecting terminal terminal box

Speed switch /

additional output II (HTL, TTL)

* Assignment depends on encoder version

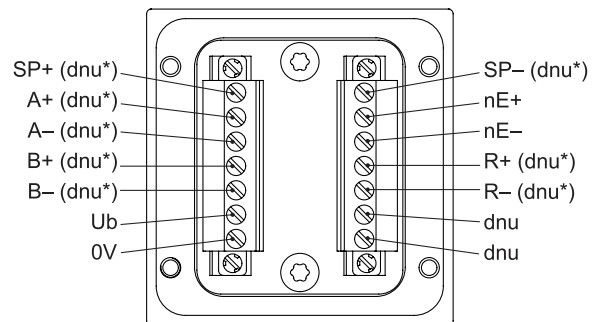

Terminal significance

DeviceNet

Connection	Description
GND	Ground for UB
UB	Voltage supply 10...30 VDC
CAN_H	CAN Bus signal (dominant HIGH)
CAN_L	CAN Bus signal (dominant LOW)
DRAIN	Shield connection

Terminal significance

Ub	Voltage supply
0V	Ground
A+	Output signal channel 1
A-	Output signal channel 1 inverted
B+	Output signal channel 2 (offset by 90° to channel 1)
B-	Output signal channel 2 inverted
R+	Zero pulse (reference signal)
R-	Zero pulse inverted
nE+	System OK+ / error output
nE-	System OK- / error output inverted
SP+	DSL_OUT1 / speed switch (open collector, solid state relay on request)
SP-	DSL_OUT2 / speed switch (0V, solid state relay on request)
dnu	Do not use

DeviceNet features

Bus protocol	DeviceNet
Device profile	Device Profil for Encoders V 1.0
Operating modes	<ul style="list-style-type: none"> ■ I/O-Polling ■ Cyclic ■ Change of State
Preset value	The „Preset“ parameter can be used to set the encoder to a predefined value that corresponds to a specific axis position of the system. The offset of encoder zero point and mechanical zero point is stored in the encoder.
Parameter functions	<p>Rotating direction: The relationship between the rotating direction and rising or falling output code values can be set in the operating parameter.</p> <p>Scaling: The parameter values set the number of steps per turn and the overall resolution.</p>
Diagnostic	<p>The encoder supports the following error warnings:</p> <ul style="list-style-type: none"> ■ Position and parameter error
Factory setting	User address 00

Output signals

Additional output II (HTL/TTL)

At positive rotating direction (see dimension)

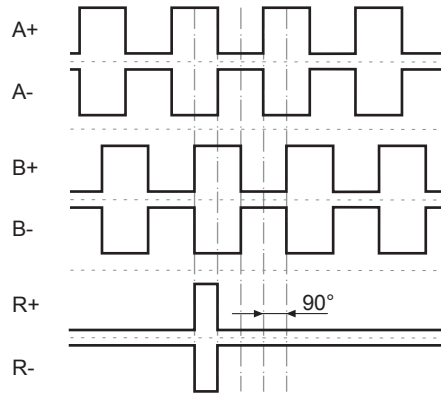

Trigger level

Incremental HTL/TTL

Electrically isolated:

The output TTL/HTL ($V_{in} = V_{out}$) at the additional output II is electrically isolated and requires a separate power supply.

Trigger level	TTL/RS422
High / Low	$\geq 2.5 \text{ V} / \leq 0.5 \text{ V}$
Transmission length	$\leq 550 \text{ m @ } 100 \text{ kHz}$
Output frequency	$\leq 600 \text{ kHz}$
Trigger level	TTL/HTL ($V_{in} = V_{out}$)
High / Low	$\geq 2.5 \text{ V} / \leq 0.5 \text{ V (TTL)}$ $\geq U_b - 3 \text{ V} / \leq 1.5 \text{ V (HTL)}$
Transmission length	$\leq 550 \text{ m @ } 100 \text{ kHz (TTL)}$ $\leq 350 \text{ m @ } 100 \text{ kHz (HTL)}$
Output frequency	$\leq 600 \text{ kHz (TTL); } \leq 350 \text{ kHz (HTL)}$

Switching characteristics

Speed switch

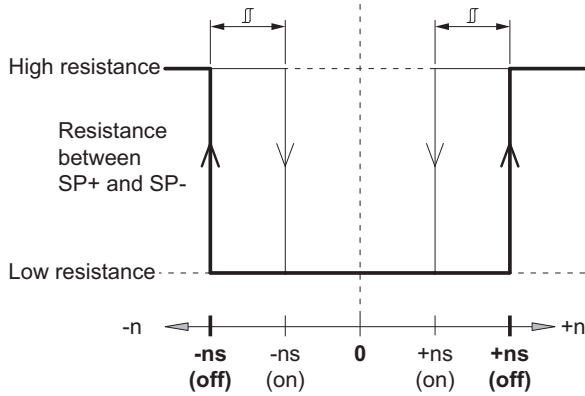

n	Speed
+ns (off)	Switch-off speed at shaft rotation in positive rotating direction (<i>see dimension</i>).
-ns (off)	Switch-off speed at shaft rotation in negative rotating direction (<i>see dimension</i>).
	Switching hysteresis Δ: 10...100 % (factory setting = 10 % min. 1 Digit)
+ns (on)	Switch-on speed at shaft rotation in positive rotating direction (<i>see dimension</i>).
-ns (on)	Switch-on speed at shaft rotation in negative rotating direction (<i>see dimension</i>).

HMG10-T - DeviceNet

Through hollow shaft

DeviceNet / 13 bit ST / 16 bit MT / Speed switch

Dimensions

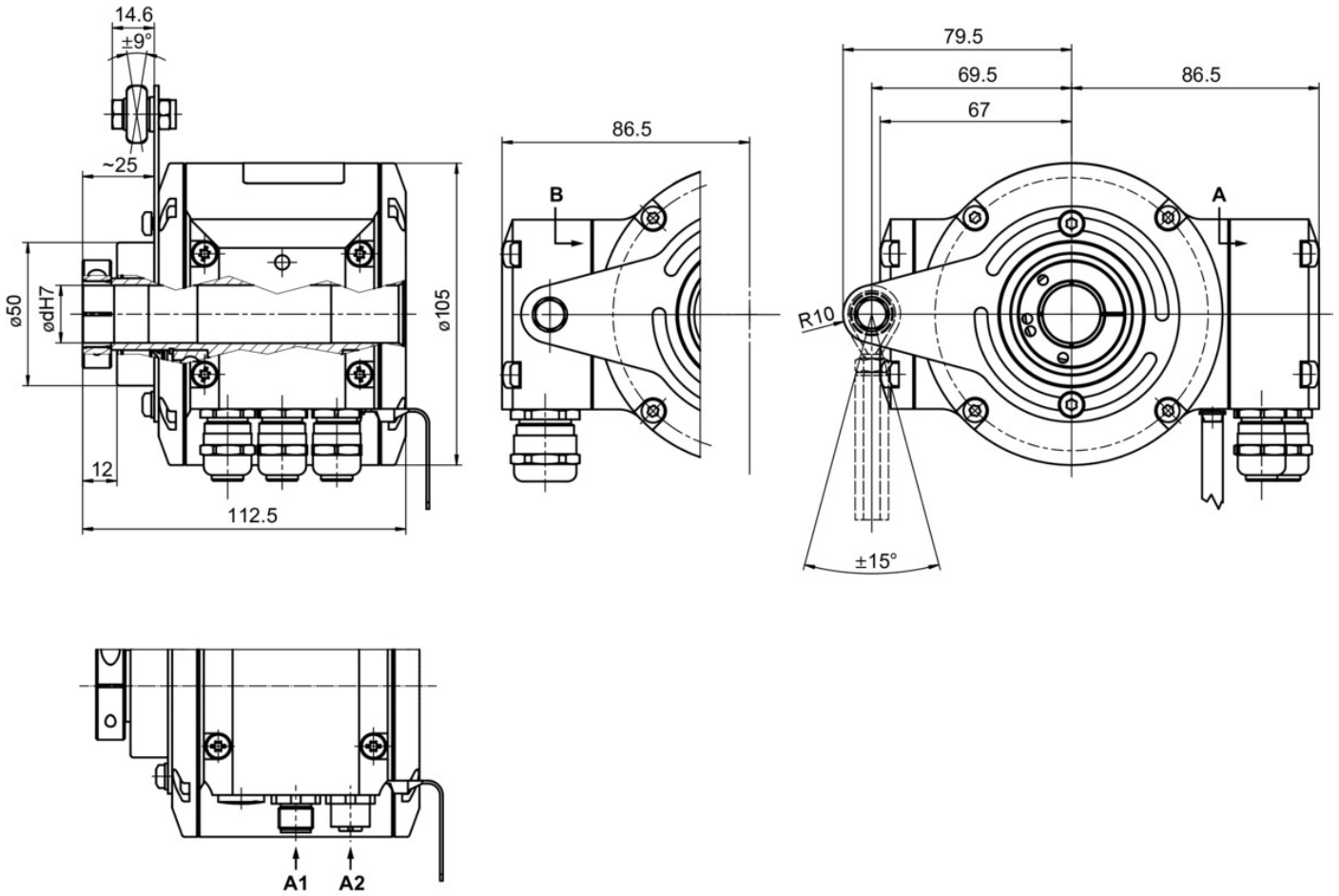

Through hollow shaft with terminal box

HMG10-T - DeviceNet

Through hollow shaft

DeviceNet / 13 bit ST / 16 bit MT / Speed switch

Ordering reference

	HMG10	#	-	T	H	#	.	#	#	DN	3	.	#	0	0	#	A
Product	HMG10																
Absolute encoder	HMG10																
Digital speed switch																	
Without	-																
With	D																
Shaft type																	
Through hollow shaft	T																
Flange (Hollow shaft)																	
Support (Support plate) for torque arm, hybrid bearings	H																
Protection class																	
IP 66 and IP 67, optimized for dusty, abrasive environment	D																
IP 66 and IP 67, optimized for oily, wet environment	L																
Through hollow shaft																	
Ø16 mm, clamping ring, A end	C																
Ø20 mm, clamping ring, A end	F																
Ø16 mm, keyway	P																
Connection																	
Bus connecting box with 3 cable glands M16, radial	5																
Bus connecting box with 2 connectors M12, radial	1																
Bus connecting box with 3 cable glands M16, radial + terminal box with 1 cable gland M20, radial	F																
Bus connecting box with 2 connectors M12, radial + terminal box with 1 cable gland M20, radial	Z																
Supply voltage (field bus)																	
10...30 VDC, DeviceNet	DN																
Resolution singleturn position																	
13 Bit	3																
Resolution multiturn position																	
No multiturn signal	0																
16 Bit	6																
Resolution speed																	
No speed signal	0																
Resolution supplement I																	
No additional output I	0																
Resolution supplement II																	
No additional output II	0																
512 ppr TTL/HTL push-pull (Vin=Vout), 6 channels, electrically isolated	1																
512 ppr TTL (RS422), 6 channels	2																
1024 ppr TTL/HTL push-pull (Vin=Vout), 6 channels, electrically isolated	5																
1024 ppr TTL (RS422), 6 channels	6																
2048 ppr TTL/HTL push-pull (Vin=Vout), 6 channels, electrically isolated	9																
2048 ppr TTL (RS422), 6 channels	4																
3072 ppr TTL/HTL push-pull (Vin=Vout), 6 channels, electrically isolated	7																
3072 ppr TTL (RS422), 6 channels	8																
4096 ppr TTL/HTL push-pull (Vin=Vout), 6 channels, electrically isolated	K																
4096 ppr TTL (RS422), 6 channels	J																
5000 ppr TTL/HTL push-pull (Vin=Vout), 6 channels, electrically isolated	G																
5000 ppr TTL (RS422), 6 channels	H																
8192 ppr TTL/HTL push-pull (Vin=Vout), 6 channels, electrically isolated	Q																
8192 ppr TTL (RS422), 6 channels	P																
Operating temperature																	
-40...+85 °C																	

HMG10-T - DeviceNet

Through hollow shaft

DeviceNet / 13 bit ST / 16 bit MT / Speed switch

Ordering reference

(1) Please specify the exact switching speed in addition to the part number (factory setting).

It may happen that not all variants of the type code can be combined. Any restrictions can be found in the web configurator at www.baumer.com or on request.

Accessories

Mounting accessories

11043628	Torque arm M6, length 67...70 mm
11004078	Torque arm M6, length 120...130 mm (≥ 71 mm)
11002915	Torque arm M6, length 425...460 mm (≥ 131 mm)
11054917	Torque arm M6 insulated, length 67...70 mm
11072795	Torque arm M6 insulated, length 120...130 mm (≥ 71 mm)
11082677	Torque arm M6 insulated, length 425...460 mm (≥ 131 mm)
11077197	Mounting kit for torque arm size M6 and earthing strap