

HMG10P-T - DeviceNet

Through hollow shaft / DeviceNet / 13 bit ST / 16 bit MT

Speed switch, number of pulses and switching speed freely programmable

Overview

- Interface DeviceNet
- Magnetic sensing method
- Resolution: singleturn 13 bit, multiturn 16 bit
- Function display via LEDs
- Multiturn sensing with Energy Harvesting technology "MicroGen", without gear or battery
- Two-sided bearing system with hybrid bearings
- Special protection against corrosion CX (C5-M)



Picture similar

HUBNER
BERLIN
A Baumer Brand

microGen
Energy Harvesting

Technical data

Technical data - electrical ratings

Voltage supply	10...30 VDC
Short-circuit proof	Yes
Consumption w/o load	≤200 mA
Initializing time	≤ 500 ms after power on
Interface	DeviceNet
Function	Multiturn
Transmission rate	125 ... 500 kBaud
Device address	Rotary switches in bus connecting box
Steps per revolution	8192 / 13 bit
Number of revolutions	65536 / 16 bit
Additional outputs	Square-wave TTL/HTL, TTL/RS422
Sensing method	Magnetic
Interference immunity	EN 61000-6-2
Emitted interference	EN 61000-6-3
Programming interface	RS485 (≤600 m)
Programmable parameters	Bus system: see bus features Additional output (number of pulses), switch-off and switch-on speeds
Diagnostic function	Position or parameter error
Status indicator	DUO-LED (bus connecting box) 4 LEDs in device back side
Approval	CE UL approval / E217823 EAC

Technical data - electrical ratings (speed switch)

Switching accuracy	± 2 % (or 1 Digit)
Switching outputs	1 output (Open collector, solid state relay on request)

Technical data - electrical ratings (speed switch)

Output switching capacity	30 VDC; ≤100 mA
Switching delay time	≤20 ms
Technical data - mechanical design	
Size (flange)	ø105 mm
Shaft type	ø16...20 mm (through hollow shaft)
Flange	Support plate, 360° freely positionable
Protection EN 60529	IP 66/IP 67
Operating speed	≤6000 rpm
Range of switching speed	ns (off) = ±2...6000 rpm, factory setting 6000 rpm
Operating torque typ.	10 Ncm
Rotor moment of inertia	950 gcm ²
Admitted shaft load	≤450 N axial ≤650 N radial
Material	Housing: aluminium alloy Shaft: stainless steel
Corrosion protection	IEC 60068-2-52 Salt mist for ambient conditions CX (C5-M) accord- ing to ISO 12944-2
Operating temperature	-40...+85 °C
Relative humidity	95 % non-condensing
Resistance	IEC 60068-2-6 Vibration 30 g, 10-2000 Hz IEC 60068-2-27 Shock 400 g, 1 ms
Weight approx.	2.2 kg (depending on version)
Connection	Bus connecting box Terminal box incremental

HMG10P-T - DeviceNet

Through hollow shaft / DeviceNet / 13 bit ST / 16 bit MT

Speed switch, number of pulses and switching speed freely programmable

Optional

- Integrated speed switch programmable
- Additional output incremental programmable

HMG10P-T - DeviceNet

Through hollow shaft / DeviceNet / 13 bit ST / 16 bit MT

Speed switch, number of pulses and switching speed freely programmable

Terminal assignment

DeviceNet - View A (see dimension)

View inside bus connecting box DeviceNet

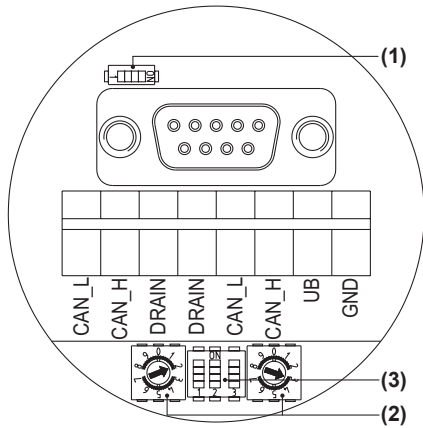

Terminals of the same significance are internally connected and identical in their functions. Max. load on the internal terminal connections UB-UB and GND-GND is 1 A each.

Terminating resistor (1)

ON = Last user

OFF = User x

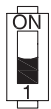

User address (2)

Defined by rotary switch.

Example: User address 23

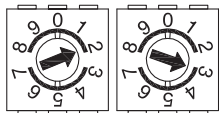

DeviceNet - Transmission rate (3)

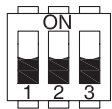

Transmission rate	Setting DIP switches		
	1	2	3
125 kBaud*	X	OFF	OFF
250 kBaud	X	OFF	ON
500 kBaud	X	ON	OFF
125 kBaud	X	ON	ON

X = Without function

* Factory setting

Terminal assignment

View A1 and A2 (see dimension)

View into connector DeviceNet

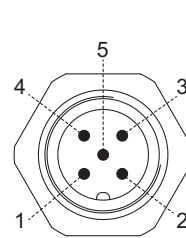

Connector M12 (male, A1)
5-pin, A-coded

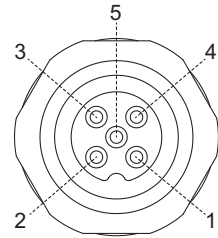

Connector M12 (female, A2)
5-pin, A-coded

Pin	Connection
1	DRAIN
2	UB
3	GND
4	CAN_H
5	CAN_L

Terminals of the same significance are internally connected and identical in their functions. Max. load on the internal terminal connections GND-GND is 1 A each.

View B (see dimension)

Connecting terminal terminal box

Programming interface / speed switch / additional output II (HTL, TTL)

* Assignment depends on encoder version

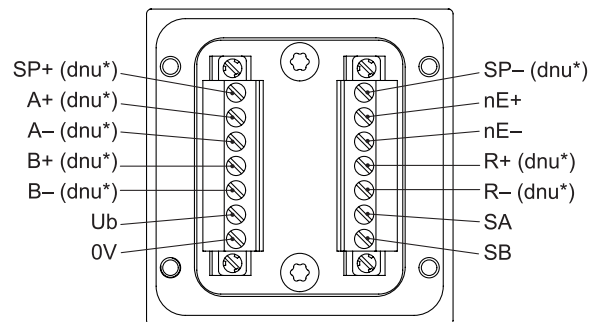

Terminal significance

DeviceNet

Connection	Description
GND	Ground for UB
UB	Voltage supply 10...30 VDC
CAN_H	CAN Bus signal (dominant HIGH)
CAN_L	CAN Bus signal (dominant LOW)
DRAIN	Shield connection

HMG10P-T - DeviceNet

Through hollow shaft / DeviceNet / 13 bit ST / 16 bit MT

Speed switch, number of pulses and switching speed freely programmable

Terminal significance

Ub	Voltage supply
0V	Ground
A+	Output signal channel 1
A-	Output signal channel 1 inverted
B+	Output signal channel 2 (offset by 90° to channel 1)
B-	Output signal channel 2 inverted
R+	Zero pulse (reference signal)
R-	Zero pulse inverted
nE+	System OK+ / error output
nE-	System OK- / error output inverted
SP+	DSL_OUT1 / speed switch (open collector, solid state relay on request)
SP-	DSL_OUT2 / speed switch (0V, solid state relay on request)
SA	RS485+ / programming interface
SB	RS485- / programming interface
dnu	Do not use

DeviceNet features

Bus protocol	DeviceNet
Device profile	Device Profil for Encoders V 1.0
Operating modes	<ul style="list-style-type: none"> ■ I/O-Polling ■ Cyclic ■ Change of State
Preset value	The „Preset“ parameter can be used to set the encoder to a predefined value that corresponds to a specific axis position of the system. The offset of encoder zero point and mechanical zero point is stored in the encoder.
Parameter functions	<p>Rotating direction: The relationship between the rotating direction and rising or falling output code values can be set in the operating parameter.</p> <p>Scaling: The parameter values set the number of steps per turn and the overall resolution.</p>
Diagnostic	<p>The encoder supports the following error warnings:</p> <ul style="list-style-type: none"> ■ Position and parameter error
Factory setting	User address 00

Output signals

Additional output II (HTL/TTL)

At positive rotating direction (see dimension)

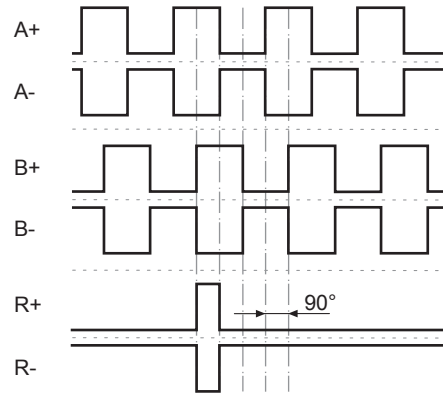

Trigger level

Incremental HTL/TTL

Electrically isolated:

The output TTL/HTL ($V_{in} = V_{out}$) at the additional output II is electrically isolated and requires a separate power supply.

Trigger level	TTL/RS422
High / Low	$\geq 2.5 \text{ V} / \leq 0.5 \text{ V}$
Transmission length	$\leq 550 \text{ m @ } 100 \text{ kHz}$
Output frequency	$\leq 600 \text{ kHz}$
Trigger level	TTL/HTL ($V_{in} = V_{out}$)
High / Low	$\geq 2.5 \text{ V} / \leq 0.5 \text{ V (TTL)}$ $\geq U_b - 3 \text{ V} / \leq 1.5 \text{ V (HTL)}$
Transmission length	$\leq 550 \text{ m @ } 100 \text{ kHz (TTL)}$ $\leq 350 \text{ m @ } 100 \text{ kHz (HTL)}$
Output frequency	$\leq 600 \text{ kHz (TTL); } \leq 350 \text{ kHz (HTL)}$

HMG10P-T - DeviceNet

Through hollow shaft / DeviceNet / 13 bit ST / 16 bit MT

Speed switch, number of pulses and switching speed freely programmable

Switching characteristics speed switch

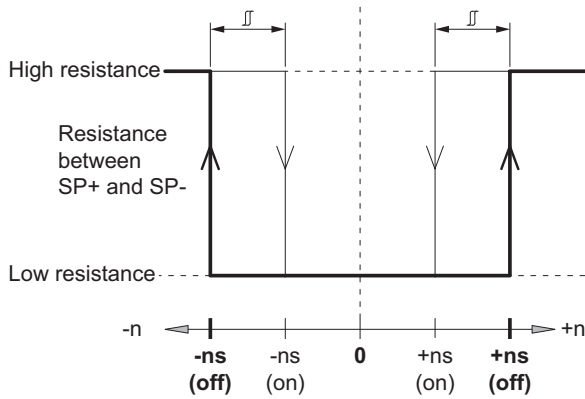

n	Speed
+ns (off)	Switch-off speed at shaft rotation in positive rotating direction (<i>see dimension</i>).
-ns (off)	Switch-off speed at shaft rotation in negative rotating direction (<i>see dimension</i>).
	Switching hysteresis Δ : 10...100 % (factory setting = 10 % min. 1 Digit)
+ns (on)	Switch-on speed at shaft rotation in positive rotating direction (<i>see dimension</i>).
-ns (on)	Switch-on speed at shaft rotation in negative rotating direction (<i>see dimension</i>).

HMG10P-T - DeviceNet

Through hollow shaft / DeviceNet / 13 bit ST / 16 bit MT

Speed switch, number of pulses and switching speed freely programmable

Dimensions

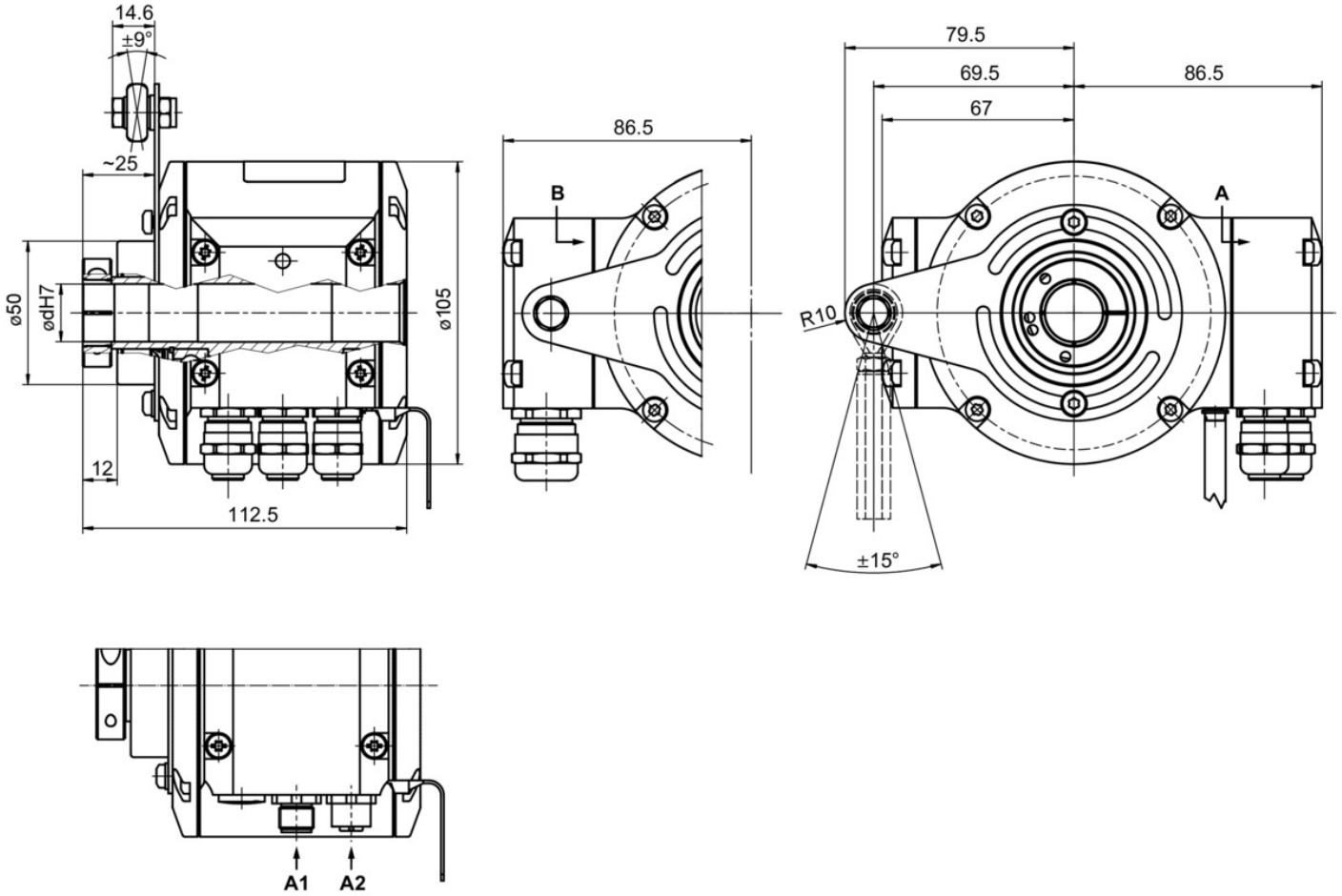

Through hollow shaft with terminal box

HMG10P-T - DeviceNet

Through hollow shaft / DeviceNet / 13 bit ST / 16 bit MT

Speed switch, number of pulses and switching speed freely programmable

Ordering reference

	HMG10P	#	-	T	H	#	.	#	#	DN	3	.	#	0	0	#	A
Product	HMG10P																
Absolute encoder	HMG10P																
Digital speed switch																	
Without	-																
With	D																
Shaft type																	
Through hollow shaft	T																
Flange (Hollow shaft)																	
Support (Support plate) for torque arm, hybrid bearings	H																
Protection class																	
IP 66 and IP 67, optimized for dusty, abrasive environment	D																
IP 66 and IP 67, optimized for oily, wet environment	L																
Through hollow shaft																	
Ø16 mm, clamping ring, A end	C																
Ø20 mm, clamping ring, A end	F																
Ø16 mm, keyway	P																
Connection																	
Bus connecting box with 3 cable glands M16, radial + terminal box with 1 cable gland M20, radial	F																
Bus connecting box with 2 connectors M12, radial + terminal box with 1 cable gland M20, radial	Z																
Supply voltage (field bus)																	
10...30 VDC, DeviceNet	DN																
Resolution singleturn position																	
13 Bit	3																
Resolution multiturn position																	
No multiturn signal	0																
16 Bit	6																
Resolution speed																	
No speed signal	0																
Resolution supplement I																	
No additional output I	0																
Resolution supplement II																	
No additional output II	0																
1024 ppr TTL/HTL push-pull (Vin=Vout), 6 channels, electrically isolated	5																
1024 ppr TTL (RS422), 6 channels	6																
Operating temperature																	
-40...+85 °C	A																

- (1) Switching speed 6000 rpm / factory setting, programmable
 (2) Factory setting, programmable

HMG10P-T - DeviceNet

Through hollow shaft / DeviceNet / 13 bit ST / 16 bit MT

Speed switch, number of pulses and switching speed freely programmable

Accessories

Mounting accessories

11043628	Torque arm M6, length 67...70 mm
11004078	Torque arm M6, length 120...130 mm (≥ 71 mm)
11002915	Torque arm M6, length 425...460 mm (≥ 131 mm)
11054917	Torque arm M6 insulated, length 67...70 mm
11072795	Torque arm M6 insulated, length 120...130 mm (≥ 71 mm)
11082677	Torque arm M6 insulated, length 425...460 mm (≥ 131 mm)
11077197	Mounting kit for torque arm size M6 and earthing strap
11077087	Mounting and dismounting set

Connectors and cables

11191145	Programming cable for the HMG10P/PMG10P bus interfaces series
----------	---

Programming accessories

11190106	Z-PA.SDL.1 - WLAN-Adapter
----------	---------------------------