

## IFRD 18N17T3/S14

Inductive sensors special versions - high temperature

Article number: 10150450

### Overview

- 6 mm
- NPN make function (NO)
- connector M12
- -25 ... 100 °C
- IP 69K



Picture similar



### Technical data

#### General data

Mounting type	Quasi-flush
Special type	Full metal housing (<kursiv>Duro-Prox</kursiv>) High temperature

Nominal sensing distance  
Sn 6 mm

Hysteresis 2 ... 20 % of Sr

#### Electrical data

Switching frequency	100 Hz
Voltage supply range +Vs	10 ... 30 VDC
Current consumption max. (no load)	14 mA
Output circuit	NPN make function (NO)
Voltage drop Vd	< 2 VDC

#### Electrical data

Output current	< 100 mA
Short circuit protection	Yes
Reverse polarity protection	Yes

#### Mechanical data

Type	Cylindrical threaded
Material (sensing face)	Stainless steel 1.4404 (V4A)
Housing material	Stainless steel 1.4404 (V4A)
Operating pressure static	< 20 bar
Dimension	18 mm
Housing length	60 mm
Connection types	Connector M12

#### Ambient conditions

Operating temperature	-25 ... +100 °C
Protection class	IP 69K

### Remarks

- Higher noise immunity (EMC), (EN 61000-6-2)

## IFRD 18N17T3/S14

Inductive sensors special versions - high temperature

Article number: 10150450

### Dimension drawing

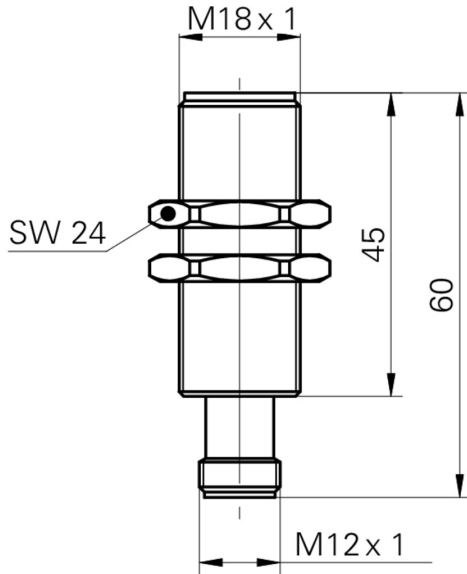

### Connection diagram

