

**Overview**

- 1,6 mm
- PNP break function (NC)
- connector M8
- -25 ... 75 °C
- IP 67



Picture similar



**Technical data**

**General data**

Mounting type	Flush
Nominal sensing distance S <sub>n</sub>	1,6 mm
Hysteresis	2 ... 20 % of S <sub>r</sub>
Output indicator	3 port LED red

**Electrical data**

Switching frequency	< 3 kHz
Voltage supply range +V <sub>s</sub>	6 ... 30 VDC
Current consumption max. (no load)	12 mA
Output circuit	PNP break function (NC)
Voltage drop V <sub>d</sub>	< 2 VDC
Output current	< 200 mA

**Electrical data**

Short circuit protection	Yes
Reverse polarity protection	Yes

**Mechanical data**

Type	Cylindrical threaded
Material (sensing face)	LCP
Housing material	Stainless steel
Dimension	5 mm
Housing length	36 mm
Connection types	Connector M8
Tightening torque max.	2 Nm (Front: 1,4 Nm)

**Ambient conditions**

Operating temperature	-25 ... +75 °C
Protection class	IP 67

**Remarks**

- M8 x 1 quick disconnect
- 3 port LED

**Dimension drawing**

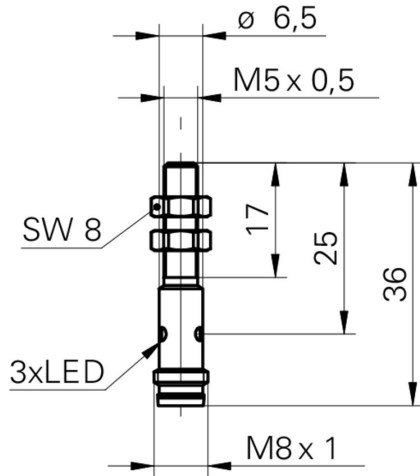

**Connection diagram**

