

## IFRM 08X9503/S35

Inductive sensors NAMUR

Article number: 10235313

### Overview

- 1,5 mm
- NAMUR
- connector M8
- -25 ... 75 °C
- IP 67



Picture similar



### Technical data

#### General data

Mounting type	Flush
Nominal sensing distance S <sub>n</sub>	1.5 mm
Approvals/certificates	ATEX 1G

#### Electrical data

Switching frequency	5 kHz
Normal operating voltage	8.2 VDC
Voltage supply range +V <sub>s</sub>	5 ... 30 VDC
Current consumption un- damped	> 4 mA
Current consumption damped	< 1 mA
Current consumption max. (no load)	10 mA
Output circuit	NAMUR
Residual ripple	< 10 % V <sub>s</sub>

#### Mechanical data

Design	Cylindrical threaded
Material (sensing face)	PBT
Housing material	Stainless steel

#### Mechanical data

Dimension	8 mm
Housing length	41 mm
Connection types	Connector M8

#### Safe maximum values

EC-type-examination Certi- ficate	SEV 21 ATEX 0551 X IECEX SEV 21.0019X
Marking	II 1G Ex ia IIC T6...T5 Ga
Current I <sub>i</sub>	< 37 mA
Voltage U <sub>i</sub>	< 13.5 VDC
Power P <sub>i</sub>	< 0.125 W
Internal capacitance C <sub>i</sub>	< 50 nF
Internal inductance L <sub>i</sub>	< 0.2 mH
Operating temperature T <sub>a</sub> (temp. class T5)	-20 ... +60 °C
Operating temperature T <sub>a</sub> (temp. class T6)	-20 ... +40 °C

#### Ambient conditions

Operating temperature	-25 ... +75 °C
Protection class	IP 67

**Remarks**

- Safety: Sensor cables leading into category 1 hazardous areas must be installed according to the guidelines as specified in EN 60079-26 (IP 67)
- Within category 1 hazardous areas sensor and cable must be securely mounted
- The metal housing has to be conductively connected to the potential equalization system

**Dimension drawing**

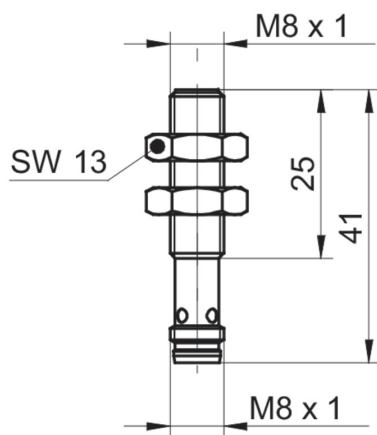

**Connection diagram**

