

Overview

- 2 ... 4 mm
- current output
- cable, 2 m
- 60 °C
- IP 67



Picture similar



Technical data

General data

Mounting type	Flush
Measuring distance Sd	2 ... 4 mm
Reference distance	2.8 ... 3.2 mm
Measuring speed	< 1 mm / ms
Repeat accuracy	0.02 mm
Linearity error	± 80 µm
Temperature coefficient	1 µm / (K mm)

Electrical data

Voltage supply range +Vs	15 ... 30 VDC
Current consumption max. (no load)	35 mA
Output circuit	Current output
Output signal	4 ... 20 mA
Load resistance +Vs min.	< 500 Ohm
Load resistance +Vs max.	< 1000 Ohm

Electrical data

Residual output ripple	< 0.5 % Vs
Short circuit protection	Yes
Reverse polarity protection	Yes

Mechanical data

Design	Cylindrical threaded
Material (sensing face)	PBT
Housing material	Brass nickel plated
Dimension	18 mm
Housing length	65 mm
Connection types	Cable, L=2 m
Tightening torque max.	40 Nm (Front: 28 Nm)

Ambient conditions

Operating temperature	0 ... +60 °C
Protection class	IP 67

Dimension drawing

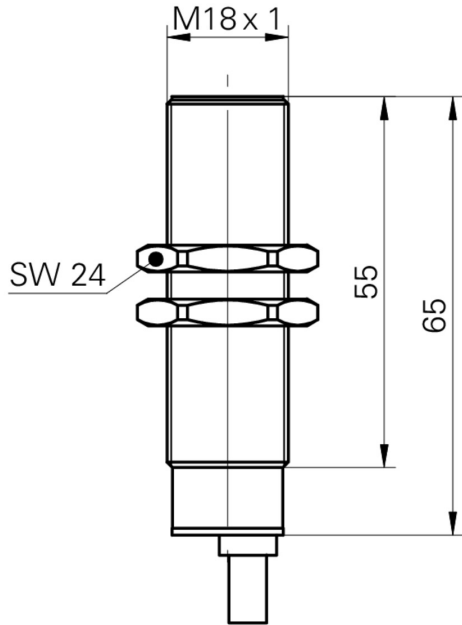

Connection diagram

