

Mounting rod with mounting plate holder 250 mm

Article number: 11707698

Overview

- Material: Aluminium
- Part of an assembly
- Different lengths available



Dimension drawing

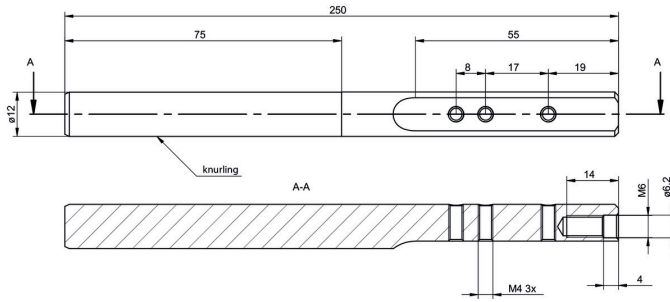

ZADAP

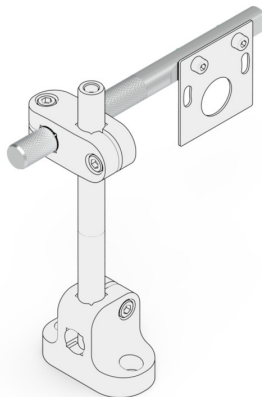

Assembly drawing