

Overview

- 200 ... 4000 mm
- pulsed red laser diode
- analog
- Teach-in: button / external
- connector M12 5 pin, rotatable
- -25 ... 50 °C
- IP 67



Picture similar



Technical data

General data

Measuring distance Sd	200 ... 4000 mm
Measuring distance Sd (white 90%)	200 ... 4000 mm
Measuring distance Sd (grey 18%)	200 ... 4000 mm
Measuring distance Sd (black 6%)	200 ... 4000 mm
Beam diameter	5 ... 20 mm
Adjustment	Teach-in: button / external
Teach-in range min.	> 100 mm
Power on indication	LED green
Soiled lens indicator	LED red
Resolution	1300 µm
Repeatability	± 5 mm (with 40 kLux ambient light)
Linearity	± 15 mm
Beam type	Point

Light Source

Light source	Pulsed red laser diode
Wave length	660 nm
Laser class	2

Electrical data

Measuring rate	10 ms
Voltage supply range +Vs	15 ... 28 VDC

Electrical data

Current consumption max. (no load)	250 mA (typ. 110 mA @ 24V)
Output circuit	Analog
Output signal	4 ... 20 mA
Load resistance (analog I)	< (+Vs - 6 V) / 0,02 A
Output current	< 100 mA
Alarm output	Push-pull
Short circuit protection	Yes
Reverse polarity protection	Yes, Vs to GND

Mechanical data

Width / diameter	25,4 mm
Height / length	66 mm
Depth	51 mm
Type	Rectangular
Housing material	Aluminum
Front (optics)	Glass
Connection types	Connector M12 5 pin, rotatable

Ambient conditions

Ambient light immunity	< 40 kLux
Operating temperature	-25 ... +50 °C
Protection class	IP 67
Typ. temp. coefficient	0,2 mm /°C

Dimension drawing

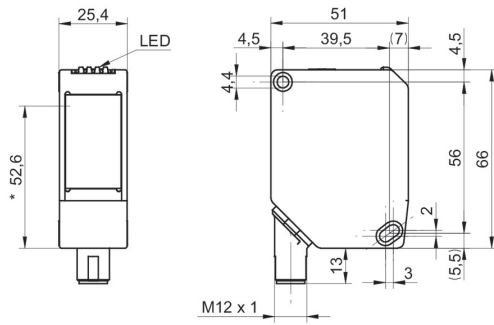

Connection diagram

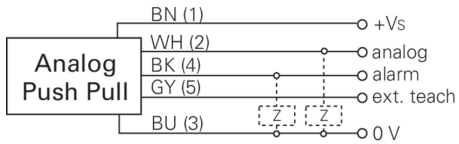

Laser warning



LASER RADIATION
DO NOT STARE INTO BEAM
Wavelength: 640...670nm
IEC 60825-1, Ed. 3, 2014
CLASS 2 LASER PRODUCT

IEC 60825-1/2014 Complies with 21 CFR 1040.10 and 1040.11 except for conformance with IEC 60825-1 Ed. 3., as described in Laser Notice No. 56, dated May 8, 2019