

Overview

- Adjustable reference distance (zero point position)
- Intuitive limitation of the measuring range
- Configurable switching output
- Selectable filters and trigger modes
- Additional data such as signal quality on request
- Export and import function for parameter sets



Picture similar



Technical data

General data

Type	Distance measuring
Version	OM70 laser line
Measuring distance Sd	100 ... 1000 mm
Measuring range Mr	900 mm
Sweet spot	500 mm
Adjustment	Webserver, Ethernet TCP/IP
Power on indication	LED green
Output indicator	LED yellow / LED red
Ethernet link indication	LED blue
Resolution	3 ... 63 µm
Repeat accuracy	1 ... 32 µm
Linearity error	± 0.19 % Mr
Beam type	Line
Temperature drift	0,065 % Sde/K
Hysteresis digital output	Adjustable

Light Source

Light source	Pulsed red laser diode
Wave length	660 nm
Laser class	2

Electrical data

Response delay	0.8 ms
Measuring frequency	2000 Hz
Voltage supply range +Vs	15 ... 28 VDC
Current consumption max. (no load)	75 mA
Output circuit	Analog and digital
Output signal	4 ... 20 mA / 2 ... 10 mA / 0 ... 10 VDC / 0 ... 5 VDC

Electrical data

Output current	< 100 mA
Switching output	Push-pull
Short circuit protection	Yes
Reverse polarity protection	Yes, Vs to GND

Communication interface

Interface	Ethernet TCP/IP
Protocol	Profinet (Class B), Modbus TCP, OPC UA, UDP streaming, EtherNet/IP
Webserver	Yes

Mechanical data

Width / diameter	26 mm
Height / length	74 mm
Depth	55 mm
Type	Rectangular, front view
Housing material	Aluminum
Front (optics)	Glass
Connection types	Connector M12 8 pin & M12 4 pin
Weight	135 g
Ambient conditions	
Ambient light immunity	< 100 kLux
Protection class	IP 67
Operating temperature	-10 ... +50 °C
Storage temperature	-20 ... +60 °C
Vibration (sinusoidal)	IEC 60068-2-6:2008 1 mm p-p at f = 10 - 55 Hz, duration 5 min per axis 30 min endurance at f = 55 Hz per axis
Shock (semi-sinusoidal)	IEC 60068-2-27:2009 30 g / 11 ms, 6 jolts per axis and direction

Remarks

- Measurement with Baumer standardized measuring equipment and targets (Measurement on 90% remission (white)). Values of Resolution, linearity error and repeat accuracy apply to a measurement with filter setting (Median: 9, Average: 128).

Dimension drawing

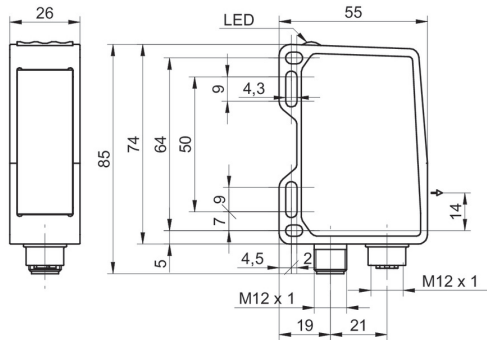

- * emitter axis

Laser warning



LASER RADIATION
DO NOT STARE INTO BEAM
Wavelength: 640...670nm

IEC 60825-1, Ed. 3, 2014
CLASS 2 LASER PRODUCT

IEC 60825-1/2014 Complies with 21 CFR 1040.10 and 1040.11 except for conformance with IEC 60825-1 Ed. 3., as described in Laser Notice No. 56, dated May 8, 2019

Connection diagram

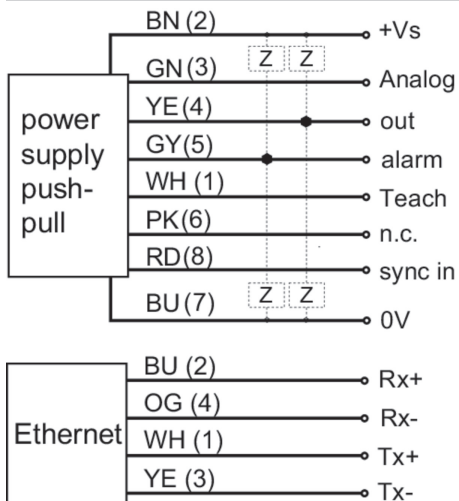

Pin assignment

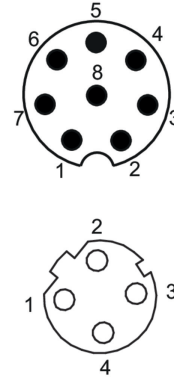

Beam characteristic (typically)

