

Quickstart Guide  
 Lens mount options and instructions for cameras  
 with M58 mount

Download latest camera software:  
[www.baumer.com/vision/software](http://www.baumer.com/vision/software)

Download latest technical documentation:  
[www.baumer.com/cameras/docs](http://www.baumer.com/cameras/docs)

Overview mount adapters

Lens mount adapter M58 to F-Mount, Art. No.: 11117852

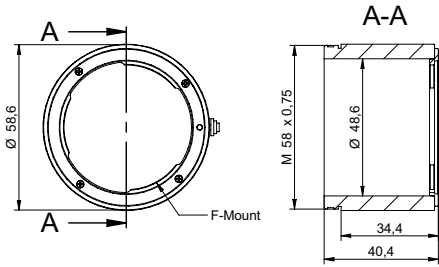

Adapter M58 / M42-Mount with flange focal length of 18 mm,  
 Art. No.: 11209260

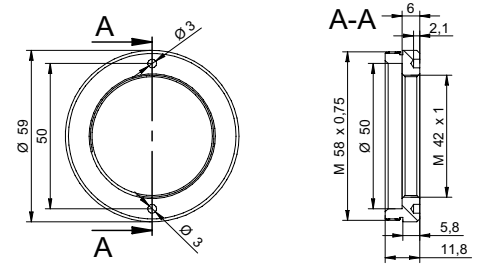

Lens mount adapter M58 to C-Mount, Art. No.: 11115198

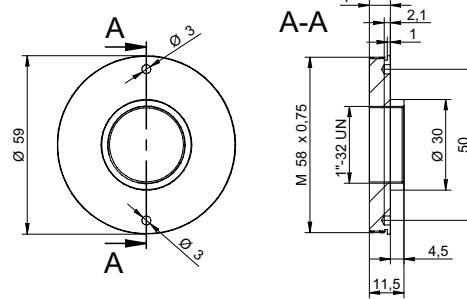

Lens mount adapter M58 to M42x1-Mount with flange focal length of 45.5 mm,  
 Art. No.: 11137781

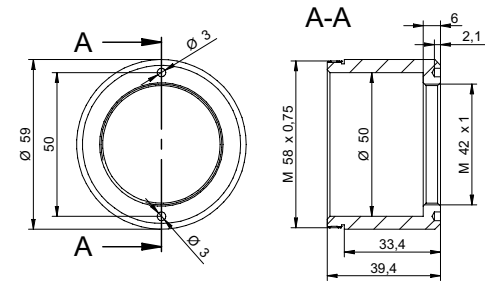

Conformity



We declare, under our sole responsibility, that the previously described Baumer lens mount adapters conform with the directives of the CE.



All Baumer lens mount adapters comply with the recommendation of the European Union concerning RoHS Rules.

Safety precautions

Notice

Ensure the sensor and lens are not contaminated with dust and airborne particles when mounting the support or the lens to the device!

The following points are very important:

- Install the camera in an environment that is as dust free as possible!
- Keep the dust cover (bag) on the camera for as long as possible!
- Hold the camera with the sensor downwards if the sensor is uncovered.
- Avoid contact with any of the camera's optical surfaces!

Further Information

For further information on our products visit [www.baumer.com](http://www.baumer.com)  
 For technical issues, please contact our technical support:  
[support\\_cameras@baumer.com](mailto:support_cameras@baumer.com) · Phone +49 (0)3528 4386-0 · Fax +49 (0)3528 4386-86  
 © Baumer Optronic GmbH · Badstrasse 30 · DE-01454 Radeberg, Germany

Technical data has been fully checked, but accuracy of printed matter not guaranteed.

Lens mount adapter M58 to M42x1-Mount with flange focal length of 9.9 mm,  
 Art. No.: 11115200

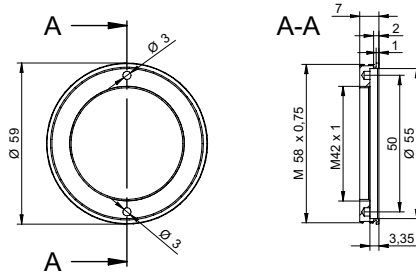

Lens mount adapter M58 to C-Mount (Scheimpflug 2.5°), Art. No.: 11165019

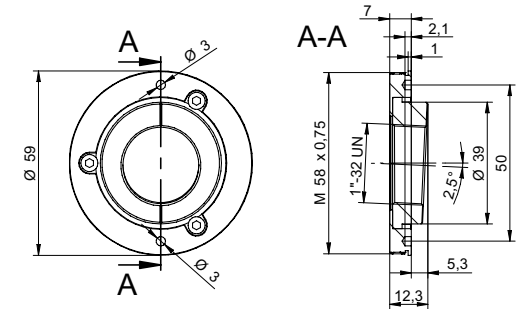

Lens mount adapter M58 / M42-Mount with flange focal length 16.0 mm,  
 Art. No.: 11204598

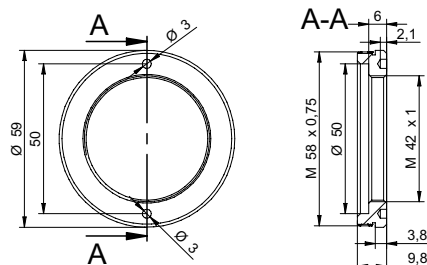

Adapter	Suitable Lenses (examples)
Adapter M58 / F-Mount (Art. No.: 11117852)	<ul style="list-style-type: none"> <li>ZVL-Rodagon-F_40mm_f5.6 (11201893)</li> <li>ZVL-FL-YFL3528 (11201890)</li> <li>ZVL-FL-YFL5028 (11014685)</li> <li>ZVL-LSF2528-F (11201894)</li> <li>ZVL-LSF3528-F (11201895)</li> <li>ZVL-LSF5028-F (11201896)</li> <li>ZVL-LSF10528-F (1120187)</li> <li>ZVL-LSF20035-F (11201898)</li> </ul> <p><a href="http://www.qioptiq.com/machine-vision-lenses">www.qioptiq.com/machine-vision-lenses</a>  <a href="http://industry.ricoh.com/en/fa_camera_lens/lens">industry.ricoh.com/en/fa_camera_lens/lens</a>  <a href="http://www.myutron.com">www.myutron.com</a></p>
Adapter M58 / C-Mount (Art. No.: 11115198)	<ul style="list-style-type: none"> <li>Kowa LMxxHC lens series, Linos MeVis C series</li> <li>Ricoh Imaging FL-BCxxx-9M series</li> <li>Schneider Kreuznach Xensation lenses</li> <li>Computar Vxxx-MPY series</li> </ul> <p><a href="http://www.kowa-lenses.com">www.kowa-lenses.com</a>  <a href="http://www.qioptiq.com/machine-vision-lenses">www.qioptiq.com/machine-vision-lenses</a>  <a href="http://industry.ricoh.com/en/fa_camera_lens/lens">industry.ricoh.com/en/fa_camera_lens/lens</a>  <a href="http://www.schneiderkreuznach.com">www.schneiderkreuznach.com</a>  <a href="https://computar.com/">https://computar.com/</a></p>
Adapter M58 / M42-Mount 9.9 (Art. No.: 11115200)	<ul style="list-style-type: none"> <li>Qioptiq Rodagon lenses with M42 mount</li> <li>Mjtron LSFxxx-S42 series</li> </ul> <p><a href="http://www.qioptiq.com/machine-vision-lenses">www.qioptiq.com/machine-vision-lenses</a>  <a href="http://www.myutron.com">www.myutron.com</a></p>
Adapter M58 / M42-Mount 16.0 (Art. No.: 11204598)	<ul style="list-style-type: none"> <li>Opto-Engineering lenses with M42 mount</li> </ul> <p><a href="http://www.opto-e.com">www.opto-e.com</a></p>
Adapter M58 / M42-Mount 18.0 (Art. No.: 11209260)	<ul style="list-style-type: none"> <li>ZVL-Interlock_Compact_2.8/21_M42 (11209330)</li> <li>ZVL-Interlock_Compact_2.4/25_M42 (11209332)</li> <li>ZVL-Interlock_Compact_2/35_M42 (11209333)</li> <li>ZVL-Interlock_Compact_2/50_M42 (11209319)</li> <li>ZVL-Interlock_Compact_2.4/85_M42 (11209334)</li> </ul> <p><a href="https://www.zeiss.com/camera-lenses/int/automated-imaging.html">https://www.zeiss.com/camera-lenses/int/automated-imaging.html</a></p>
Adapter M58 / M42-Mount 45.5 (Art. No.: 11137781)	<ul style="list-style-type: none"> <li>ZEISS Interlock 2/100</li> </ul> <p><a href="https://www.zeiss.com/camera-lenses/int/automated-imaging.html">https://www.zeiss.com/camera-lenses/int/automated-imaging.html</a></p>
Adapter M58 / C-Mount (Scheimpflug 2.5°) (Art. No.: 11165019)	<ul style="list-style-type: none"> <li>C mount lenses in applications that require a 2.5° lens angle</li> </ul>

1. Assemble lens mount adapter + lens (fixed).

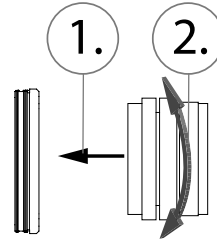

2. Screw lens mount adapter + lens into camera (loose).

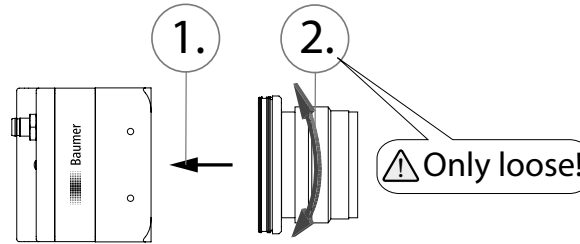

3. Remove the stickers (1). Screw in grub screws (loose) (2).

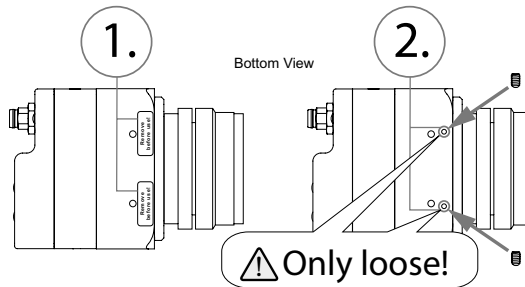

4. Set lens distance to infinity.

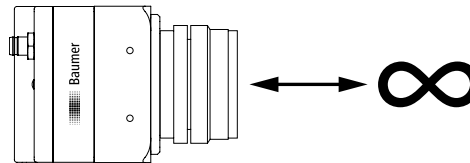

5. Start live image acquisition with *Baumer Camera Explorer*.



6. Point camera to far distance (> 10 m).

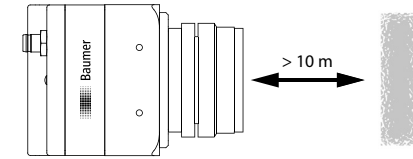

7. Rotate lens until image is sharp.

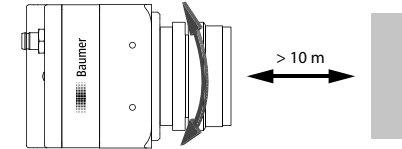

**Notice**  
If flange back is not correctly adjusted image may not be sharp.

8. Fix lens mount adapter to camera with a torque of 0.1 Nm (Allen key M2).

