

## Reducer insert HS35 $\varnothing$ 16 mm

Article number: 11087747

### Overview

- Easy assembly by plugging in
- Exchange possible without tools
- Quick adjustment of the required diameter
- Suitable for high speeds

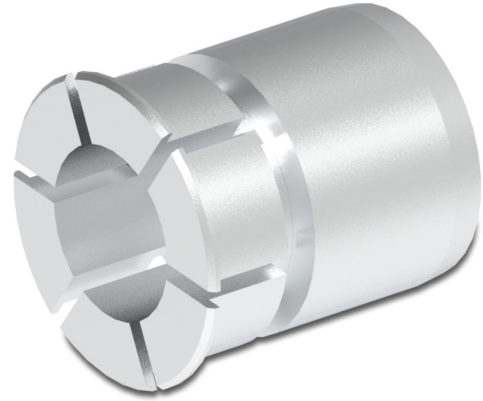

### Description

Allows the mounting on diameter 16 mm on the motor shaft. Basis for the reducer insert is a hollow shaft diameter of 25.4 mm. Subsequent replacement without tools. Outer diameter: 25.4 mm, Material: Aluminium

### Dimensions

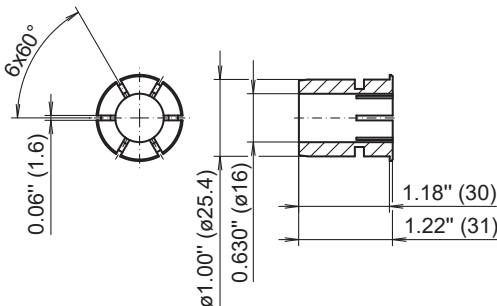

ø nominal dimension		tolerance		
inch (in ")	metric (in mm)		inch (in 1/1000")	metric (in µm)
0.630"	16	H8	+1.06 0	+27 0