

Spring disk coupling K35 WD 11PF4 + 12PF4

Article number: 11220484

Overview

- High quality torsionally stiff and backlash free coupling
- Compensating of mounting errors
- Balanced torsional rigidity (torsional spring constant)
- Form-fit connection thanks to keyway

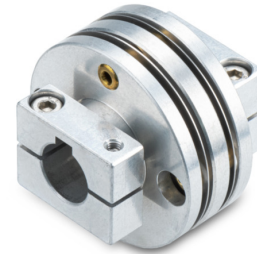

Technical data

Technical data

Shaft diameter D1	11 mm
Shaft diameter D2	12 mm
Keyway D1	4 mm
Keyway D2	4 mm
Operating speed	≤15000 rpm
Moment of inertia	$89 \cdot 10^{-3} \text{ kgcm}^2$
Torsional rigidity	900 Nm/rad
Operating torque	≤2 Ncm

Technical data

Maximum torque	3 Nm
Admissible axial movement	± 0.7 mm
Admissible parallel misalignment	± 0.2 mm
Admissible angular error	± 1 °
Electrical insulation	No
Weight approx.	50 g
Material	Spring disks: X12 CrNi 17 7

Description

Spring disk coupling, which combines the necessary torsional stiffness with the ability to compensate for axial displacement which occurs especially through heat expansion of the drive and the play backlash of the ball bearings.

Dimensions

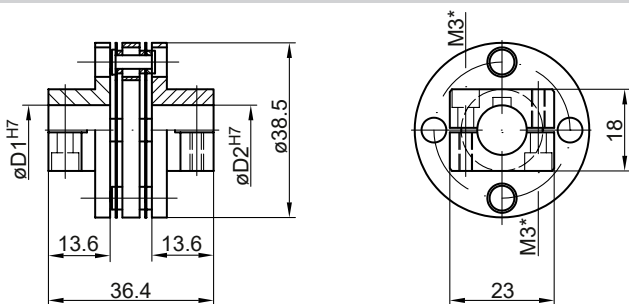

* Maximum tightening torque:
Mt = 1 Nm (plastic side)
Mt = 1.3 ± 10 % Nm (metal side)

Assembly drawing

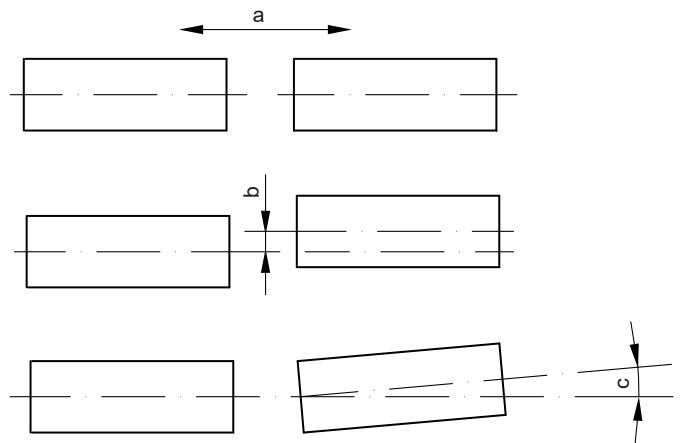

a = Admissible axial movement
b = Admissible parallel misalignment
c = Admissible angular error