

Tube Module 6 mm M62 hard anodized

Article number: 11185376

Overview

- modular extension of the lens protection
- thread: M62
- length 6 mm



Technical data

Mechanical data

Inner diameter	59 mm
External diameter	65 mm
Weight	≤ 10 g

Mechanical data

Thread	M62 × 0,75
Length of tube	6 mm
Material	aluminum, hard-anodized
Sealing	EPDM

Dimension drawing

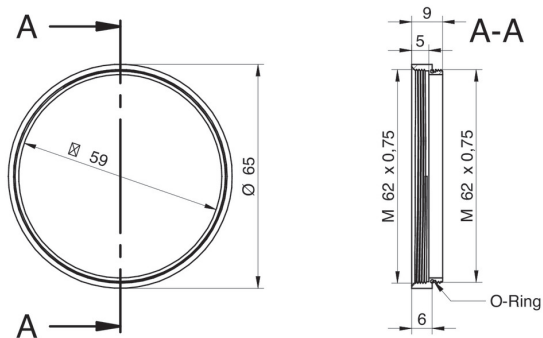

Principle

Optional accessories for protection class IP65/67:

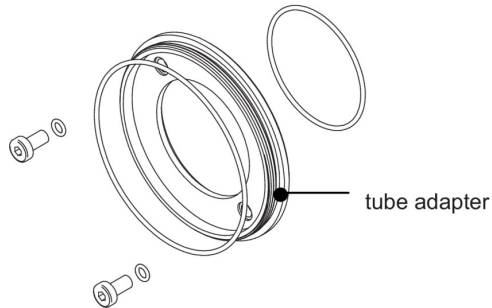

tube adapter

- hard-anodized, incl. sealing and screws
 \varnothing 49.5 mm (VCXG.I 11185373)
 \varnothing 65 mm (VCXG.I 11185377)
 \varnothing 65 mm (VLXT 11193125)

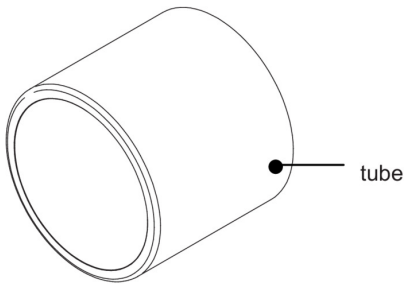

tube

- hard-anodized, cover glass PMMA
 \varnothing 49.5 mm, length 44 mm (11701124)
 \varnothing 65 mm, length 58 mm (11701125)
- hard-anodized, tempered laminated safety glass
 \varnothing 49.5 mm, length 44 mm (11195425)
 \varnothing 65 mm, length 58 mm (11195426)

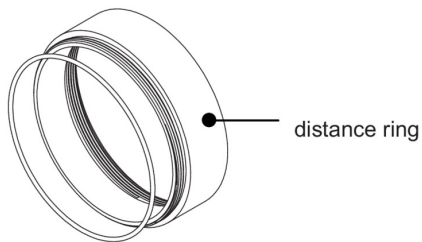

distance ring

- hard-anodized, incl. sealing
 \varnothing 49.5 mm, length 6 mm (11185372)
 \varnothing 49.5 mm, length 12 mm (11185371)
 \varnothing 49.5 mm, length 36 mm (11211571)
- \varnothing 65 mm, length 6 mm (11185376)
 \varnothing 65 mm, length 12 mm (11185375)
 \varnothing 65 mm, length 36 mm (111988906)