



## Operating Manual

V CXG / .XC / .I / .I.XT / .PTP / .I.PTP cameras  
(Gigabit Ethernet)

V CXU / MP cameras  
(USB 3.0)

EN-US

# Table of Contents

<b>1. General Information</b> .....	<b>9</b>
1.1 Software Licensing Information.....	11
<b>2. General Safety Instructions</b> .....	<b>13</b>
<b>3. Camera Models</b> .....	<b>14</b>
3.1 VCXG / .PTP .....	17
3.2 VCXG.XC .....	19
3.3 VCXG.I / .XT / .PTP .....	20
3.4 VCXU .....	26
<b>4. Installation</b> .....	<b>28</b>
4.1 Environmental Requirements.....	28
4.2 Heat Transmission .....	29
4.2.1 Emergency shutdown at Overtemperature ( $\geq$ Rel. 2 only) .....	32
4.3 Lens mounting .....	35
4.4 IP Protection classes (VCXG.I / .I.XT) .....	36
4.5 Filter replacement .....	37
4.6 Cable requirements for UL conformity .....	37
4.7 Cleaning.....	38
4.8 Mechanical Tests.....	39
<b>5. Pin-Assignment / LED-Signaling</b> .....	<b>40</b>
5.1 VCXG / .PTP / .XC .....	40
5.1.1 Ethernet Interface.....	40
5.1.2 Power Supply and IOs.....	41
5.1.3 GPIO (General Purpose Input/Output) .....	42
5.1.4 Digital-IO.....	43
5.1.5 LED Signaling.....	43
5.2 VCXG.I / .XT / .PTP .....	44
5.2.1 Ethernet Interface.....	44
5.2.2 Power Supply and IOs.....	44
5.2.3 Digital-IO .....	45
5.2.4 LED Signaling.....	46
5.3 VCXU .....	47
5.3.1 USB 3.0 Interface .....	47
5.3.2 Digital-IOs.....	47
5.3.3 GPIO (General Purpose Input/Output) .....	48
5.3.4 Digital-IO.....	49
5.3.5 LED Signaling.....	49
<b>6. Product Specifications</b> .....	<b>50</b>
6.1 Spectral Sensitivity.....	50
6.2 Sensor position accuracy.....	59
6.2.1 VCXG / .XC / .PTP .....	59
6.2.2 VCXG.I / .I.XT / .I.PTP .....	60
6.2.3 VCXU .....	61
6.3 Software.....	62

6.3.1	Baumer GAPI .....	62
6.3.2	NeoAPI .....	62
6.3.3	3 <sup>rd</sup> Party Software .....	62
<b>7.</b>	<b>Camera Functions .....</b>	<b>63</b>
7.3.1	AcquisitionAbort.....	64
7.3.2	AcquisitionFrameCount .....	64
7.3.3	AcquisitionFrameRate .....	64
7.3.4	AcquisitionFrameRateEnable .....	65
7.3.5	AcquisitionMode .....	65
7.3.6	AcquisitionStart.....	66
7.3.7	AcquisitionStatus .....	66
7.3.8	AcquisitionStatusSelector.....	66
7.3.9	AcquisitionStop .....	67
7.3.10	ExposureAuto (except .PTP / .I.PTP).....	67
7.3.11	ExposureMode.....	67
7.3.12	ExposureTime .....	68
7.3.12.1	VCXG / .XC / .I / .I.XT / .PTP / .I.PTP .....	69
7.3.12.2	VCXU .....	70
7.3.13	ExposureTimeGapMax (≥ Rel. 4 only) .....	71
7.3.14	ExposureTimeGapMin (≥ Rel. 4 only) .....	71
7.3.15	ReadoutMode.....	72
7.3.16	ShortExposureTimeEnable.....	73
7.3.17	TriggerActivation.....	73
7.3.18	TriggerDelay .....	73
7.3.19	TriggerMode .....	74
7.3.19.1	Timings of the image transmission VCXG .....	74
7.3.19.2	Timings of the image transmission VCXU.....	75
7.3.20	TriggerOverlap.....	75
7.3.21	TriggerSelector .....	75
7.3.22	TriggerSoftware .....	75
7.3.23	TriggerSource .....	76
7.1	Category: Action Control (GigE only) .....	77
7.1.1	ActionDeviceKey .....	77
7.1.2	ActionGroupKey .....	77
7.1.3	ActionGroupMask .....	77
7.1.4	ActionSelector .....	77
7.2	Category: AnalogControl.....	78
7.2.1	BalanceWhiteAuto (color cameras only) .....	78
7.2.2	BlackLevel .....	78
7.2.2.1	VCXG / .XC / .I / .I.XT / .PTP / .I.PTP .....	79
7.2.2.2	VCXU.....	79
7.2.3	BlackLevelSelector.....	80
7.2.4	Gain .....	80
7.2.4.1	VCXG / .XC / .I / .I.XT / .PTP / .I.PTP .....	81
7.2.4.2	VCXU.....	82
7.2.5	GainAuto (except .PTP / .I.PTP).....	83
7.2.6	GainSelector.....	83
7.2.7	Gamma .....	84
7.3	Category: AutoFeatureControl (≥ Release 3 only, except .PTP / .I.PTP).....	85
7.3.1	AutoFeatureHeight .....	87
7.3.2	AutoFeatureOffsetX.....	87
7.3.3	AutoFeatureOffsetY .....	88
7.3.4	AutoFeatureRegionMode .....	88
7.3.5	AutoFeatureRegionReference.....	89
7.3.6	AutoFeatureRegionSelector .....	89
7.3.7	AutoFeatureWidth.....	89
7.3.8	BalanceWhiteAutoStatus.....	90
7.3.9	BrightnessAutoNominalValue .....	90
7.3.10	BrightnessAutoPriority .....	90

7.3.11 ExposureAutoMaxValue .....	91
7.3.12 ExposureAutoMinValue .....	92
7.3.13 GainAutoMaxValue.....	92
7.3.14 GainAutoMinValue.....	92
7.4 Category: ChunkDataControl.....	93
7.4.1 ChunkEnable .....	94
7.4.2 ChunkModeActive .....	94
7.4.3 ChunkSelector .....	94
7.4.3.1 VCXG /.XC / .I / .IXT / .PTP / .I.PTP / VCXU .....	95
7.5 Category: ColorTransformationControl (color cameras only).....	98
7.5.1 ColorTransformationAuto (≥ Release 3 only) .....	98
7.5.2 ColorTransformationEnable.....	99
7.5.3 ColorTransformationFactoryListSelector .....	99
7.5.4 ColorTransformationOutputColorSpace .....	99
7.5.5 ColorTransformationResetToFactoryList .....	100
7.5.6 ColorTransformationValue .....	100
7.5.7 ColorTransformationValueSelector.....	100
7.6 Category: CounterAndTimerControl.....	101
7.6.1 CounterDuration .....	101
7.6.2 CounterEventActivation .....	101
7.6.3 CounterEventSource .....	102
7.6.4 CounterReset .....	102
7.6.5 CounterResetActivation.....	103
7.6.6 CounterResetSource .....	103
7.6.7 CounterSelector .....	103
7.6.8 CounterValue.....	104
7.6.9 CounterValueAtReset.....	104
7.6.10 FrameCounter .....	104
7.6.11 TimerDelay.....	105
7.6.12 TimerDuration .....	105
7.6.13 TimerSelector .....	105
7.6.14 TimerTriggerActivation.....	106
7.6.15 TimerTriggerSource.....	106
7.7 Category: CustomDataControl (≥ Release 3 only).....	107
7.7.1 CustomData.....	107
7.7.2 CustomDataSelector .....	107
7.8 Category: DeviceControl.....	108
7.8.1 DeviceCharacterSet .....	108
7.8.2 DeviceEventChannelCount .....	108
7.8.3 DeviceFamilyName .....	108
7.8.4 DeviceFirmwareVersion.....	109
7.8.6 DeviceGenCPVersionMinor.....	109
7.8.7 DeviceLinkCommandTimeout .....	109
7.8.8 DeviceLinkHeartbeatMode .....	110
7.8.9 DeviceLinkHeartbeatTimeout .....	110
7.8.10 DeviceLinkSelector.....	110
7.8.11 DeviceLinkSpeed.....	111
7.8.12 DeviceLinkThroughputLimit.....	111
7.8.13 DeviceManufacturerInfo .....	111
7.8.14 DeviceModelName .....	112
7.8.15 DeviceRegistersEndiannes .....	112
7.8.16 DeviceReset .....	112
7.8.17 DeviceResetToDeliveryState.....	113
7.8.18 DeviceSFNCVersionMajor.....	113
7.8.19 DeviceSFNCVersionMinor.....	113
7.8.20 DeviceSFNCVersionSubMinor .....	114
7.8.21 DeviceScanType .....	114
7.8.22 DeviceSensorType .....	114
7.8.23 DeviceSerialNumber.....	114
7.8.24 DeviceStreamChannelCount.....	115
7.8.25 DeviceStreamChannelEndianness.....	115
7.8.26 DeviceStreamChannelPacketSize .....	115



7.8.27	DeviceStreamChannelSelector	115
7.8.28	DeviceStreamChannelType	116
7.8.29	DeviceTLType	116
7.8.30	DeviceTLVersionMajor	116
7.8.31	DeviceTLVersionMinor	116
7.8.32	DeviceTLVersionSubMinor	117
7.8.33	DeviceTemperature	117
7.8.34	DeviceTemperatureExceeded	117
7.8.35	DeviceTemperatureSelector	117
7.8.36	DeviceTemperatureStatus	118
7.8.37	DeviceTemperatureStatusTransition	118
7.8.38	DeviceTemperatureStatusTransitionSelector (≥ Rel. 2 only)	118
7.8.39	DeviceType	119
7.8.40	DeviceUserID	119
7.8.41	DeviceVendorName	119
7.8.42	DeviceVersion	119
7.8.43	ReadOutTime	120
7.8.44	TimestampLatch	120
7.8.45	TimestampLatchValue	120
7.8.46	TimestampLatchValuePtpDays	121
7.8.47	TimestampReset	121
7.8.48	USB2SupportEnable	122
7.9	Category: DigitalIOControl	123
7.9.1	LineDebouncerHighTimeAbs	125
7.9.2	LineDebouncerLowTimeAbs	125
7.9.3	LineFormat (only VCXG.I / .XT / .PTP)	126
7.9.4	LineInverter	127
7.9.5	LineMode	127
7.9.6	LinePWMConfigurationMode (only VCXG.I / .XT / .PTP)	128
7.9.7	LinePWMDuration (only VCXG.I / .XT / .PTP)	129
7.9.8	LinePWMDutyCycle (only VCXG.I / .XT / .PTP)	129
7.9.9	LinePWMMaxDuration (only VCXG.I / .XT / .PTP)	130
7.9.10	LinePWMMaxDutyCycle (only VCXG.I / .XT / .PTP)	130
7.9.11	LinePWMMode (only VCXG.I / .XT / .PTP)	130
7.9.12	LinePWMOffTime (only VCXG.I / .XT / .PTP)	131
7.9.13	LinePWMPeriodTime (only VCXG.I / .XT / .PTP)	131
7.9.14	LineSelector	132
7.9.14.1	General Purpose Input/Output - GPIO (except VCXG.I/.I.XT/.PTP)	133
7.9.15	LineSource	134
7.9.16	LineStatus	136
7.9.17	LineStatusAll	136
7.9.18	UserOutputSelector	136
7.9.19	UserOutputValue	137
7.9.20	UserOutputValueAll	137
7.10	Category: EventControl	138
7.10.20.1	DeviceTemperaturStatusChanged	142
7.10.1	EventNotification	142
7.10.2	EventSelector	143
7.10.3	LostEventCounter	143
7.11	Category: ImageFormatControl	144
7.11.1	BinningHorizontal	147
7.11.1.1	VCXG / .XC / .I / .I.XT / .PTP / .I.PTP	148
7.11.1.2	VCXU	149
7.11.2	BinningHorizontalMode	150
7.11.3	BinningSelector	150
7.11.4	BinningVertical	151
7.11.4.1	VCXG / .I / .I.XT / .PTP / .I.PTP	151
7.11.4.2	VCXU	152
7.11.5	BinningVerticalMode	153
7.11.6	Category: ImageFormatControl → CalibrationControl (MP cameras only)	154
7.11.6.1	CalibrationAngleOfPolarizationOffset	155
7.11.6.2	CalibrationEnable	155

7.11.6.3	CalibrationMatrixValue	155
7.11.6.4	CalibrationMatrixValueSelector	156
7.11.7	ComponentEnable (MP cameras only)	156
7.11.8	ComponentSelector (MP cameras only)	156
7.11.9	Height	157
7.11.9.1	VCXG /.XC / .I / .I.XT / .PTP / .I.PTP	158
7.11.9.2	VCXU	159
7.11.10	HeightMax	160
7.11.10.1	VCXG /.XC / .I / .I.XT / .PTP / .I.PTP	160
7.11.10.2	VCXU	161
7.11.11	OffsetX	162
7.11.12	OffsetY	163
7.11.13	PixelFormat	163
7.11.13.1	VCXG /.XC / .I / .I.XT / .PTP / .I.PTP	165
7.11.13.2	VCXU	166
7.11.14	ReverseX (mono cameras / pixel formats only)	167
7.11.15	ReverseY (monochrome cameras / pixel formats only)	168
7.11.16	SensorHeight	168
7.11.17	SensorName (≥ Release 3 only)	168
7.11.18	SensorPixelHeight (≥ Release 3 only)	169
7.11.19	SensorPixelWidth (≥ Release 3 only)	169
7.11.20	SensorShutterMode	170
7.11.21	SensorWidth	172
7.11.22	TestPattern	172
7.11.23	TestPatternGeneratorSelector	173
7.11.24	Width	173
7.11.24.1	VCXG /.XC / .I / .I.XT / .PTP / .I.PTP	174
7.11.24.2	VCXU	175
7.11.25	WidthMax	176
7.11.25.1	VCXG /.XC / .I / .I.XT / .PTP / .I.PTP	176
7.11.25.2	VCXU	177
7.12	Category: LUTControl	179
7.12.1	DefectPixelCorrection	181
7.12.2	DefectPixelListEntryActive	181
7.12.3	DefectPixelListEntryPosX	182
7.12.4	DefectPixelListEntryPosY	182
7.12.5	DefectPixelListIndex	182
7.12.6	DefectPixelListSelector	182
7.12.7	Fixed Pattern Noise Correction (FPNC)	183
7.12.7.1	VCXG /.XC / .I / .I.XT / .PTP / .I.PTP	183
7.12.7.2	VCXU	184
7.12.8	LUTContent	185
7.12.9	LUTEnable	185
7.12.10	LUTIndex	185
7.12.11	LUTSelector	186
7.12.12	LUTValue	186
7.13	Category: MemoryManagement (≥ Rel. 3 only)	186
7.13.1	MemoryMaxBlocks	186
7.14	Category: SequencerControl (≥ Rel. 2 only)	187
7.14.1	SequencerConfigurationMode	188
7.14.2	SequencerFeatureEnable	188
7.14.3	SequencerFeatureSelector	189
7.14.4	SequencerMode	190
7.14.5	SequencerPathSelector	190
7.14.6	SequencerSetActive	190
7.14.7	SequencerSetLoad	191
7.14.8	SequencerSetNext	191
7.14.9	SequencerSetSave	191
7.14.10	SequencerSetSelector	191
7.14.11	SequencerSetStart	192
7.14.12	SequencerTriggerActivation	192
7.14.13	SequencerTriggerSource	193

7.15 Category: TransportLayerControl.....	193
7.15.1 EnergyEfficientEthernetEnable (≥ Rel. 3 only) .....	193
7.15.2 Category: TransportLayerControl → GigEVision.....	194
7.15.2.1 GVSPConfigurationBlockID64Bit.....	194
7.15.2.2 GevCCP.....	194
7.15.2.3 GevCurrentDefaultGateway.....	194
7.15.2.4 GevCurrentIPAddress.....	195
7.15.2.5 GevCurrentIPConfigurationDHCP.....	195
7.15.2.6 GevCurrentIPConfigurationLLA.....	195
7.15.2.7 GevCurrentIPConfigurationPersistentIP.....	196
7.15.2.8 GevCurrentSubnetMask.....	196
7.15.2.9 GevFirstURL.....	196
7.15.2.10 GevGVCPEExtendedStatusCodes.....	196
7.15.2.11 GevGVCPEExtendedStatusCodesSelector.....	197
7.15.2.12 GevGVCPPendingAck.....	197
7.15.2.13 GevIPConfigurationStatus.....	197
7.15.2.14 GevInterfaceSelector.....	198
7.15.2.15 GevMACAddress.....	198
7.15.2.16 GevMCDA.....	198
7.15.2.17 GevMCPHostPort.....	198
7.15.2.18 GevMCRC.....	199
7.15.2.19 GevMCSP.....	199
7.15.2.20 GevMCTT.....	199
7.15.2.21 GevNumberOfInterfaces.....	199
7.15.2.22 GevPAUSEFrameReception.....	200
7.15.2.23 GevPersistentDefaultGateway.....	200
7.15.2.24 GevPersistentIPAddress.....	200
7.15.2.25 GevPersistentSubnetMask.....	200
7.15.2.26 GevPrimaryApplicationIPAddress.....	201
7.15.2.27 GevPrimaryApplicationSocket.....	201
7.15.2.28 GevPrimaryApplicationSwitchoverKey.....	201
7.15.2.29 GevSCDA.....	201
7.15.2.30 GevSCFTD.....	202
7.15.2.31 GevSCPD.....	202
7.15.2.32 GevSCPHostPort.....	202
7.15.2.33 GevSCPInterfaceIndex.....	202
7.15.2.34 GevSCPSDoNotFragment.....	203
7.15.2.35 GevSCPSFireTestPacket.....	203
7.15.2.36 GevSCPSPacketSize.....	203
7.15.2.37 GevSCSP.....	203
7.15.2.38 GevSecondURL.....	204
7.15.2.39 GevStreamChannelSelector.....	204
7.15.2.40 GevSupportedOption.....	204
7.15.2.41 GevSupportedOptionSelector.....	205
7.15.2.42 InterfaceSpeedMode.....	206
7.15.3 PayloadSize.....	206
7.15.4 Category: Category: TransportLayerControl → PtpControl (.PTP only).....	207
7.15.4.1 PtpClockAccuracy.....	209
7.15.4.2 PtpClockID.....	209
7.15.4.3 PtpDataSetLatch.....	209
7.15.4.4 PtpEnable.....	210
7.15.4.5 PtpGrandmasterClockID.....	210
7.15.4.6 PtpMode.....	210
7.15.4.7 PtpOffsetFromMaster.....	211
7.15.4.8 PtpParentClockID.....	211
7.15.4.9 PtpServoStatus.....	211
7.15.4.10 PtpStatus.....	212
7.15.5 Category: TransportLayerControl → USB3Vision.....	212
7.15.5.1 InterfaceSpeedMode.....	212
7.15.5.2 SIControl.....	213
7.15.5.3 SIPayloadFinalTransfer1Size.....	213
7.15.5.4 SIPayloadFinalTransfer2Size.....	213

7.15.5.5 SIPayloadTransferCount.....	213
7.15.5.6 SIPayloadTransferSize .....	214
7.16 Category: UserSetControl.....	214
7.16.1 UserSetDefault .....	214
7.16.2 UserSetFeatureEnable .....	215
7.16.3 UserSetFeatureSelector .....	215
7.16.4 UserSetLoad .....	218
7.16.5 UserSetSave .....	218
7.16.6 UserSetSelector .....	218
<b>8. VCXG /.XC/.I.I.XT/.PTP /.I.PTP – Interface Functionalities .....</b>	<b>219</b>
8.1 Device Information .....	219
8.2 Packet Size and Maximum Transmission Unit (MTU).....	219
8.3 Inter Packet Gap (IPG) .....	219
8.3.1 Example 1: Multi Camera Operation – Minimal IPG.....	220
8.3.2 Example 2: Multi Camera Operation – Optimal IPG.....	220
8.4 Transmission Delay.....	221
8.4.1 Time Saving in Multi-Camera Operation .....	221
8.4.2 Configuration Example .....	222
8.5 Multicast.....	224
8.6 IP Configuration .....	225
8.6.1 Persistent IP .....	225
8.6.2 DHCP (Dynamic Host Configuration Protocol).....	225
8.6.3 LLA .....	226
8.6.4 Force IP.....	226
8.7 Packet Resend.....	227
8.7.1 Normal Case.....	227
8.7.2 Fault 1: Lost Packet within Data Stream .....	227
8.7.3 Fault 2: Lost Packet at the End of the Data Stream .....	228
8.7.4 Termination Conditions .....	228
8.8 Message Channel .....	229
8.8.1 Event Generation .....	229
8.9 Action Command / Trigger over Ethernet.....	230
8.9.1 Example: Triggering Multiple Cameras .....	230
<b>9. VCXU – Interface Functionalities .....</b>	<b>231</b>
9.1 Device Information .....	231

# 1. General Information

Thanks for purchasing a camera of the Baumer family. This User's Guide describes how to connect, set up and use the camera.



Read this manual carefully and observe the notes and safety instructions!

## Support

In the case of any questions please contact our Technical & Application Support Center.

Worldwide: **Baumer Optronic GmbH**  
Badstrasse 30  
DE-01454 Radeberg, Germany

Tel: +49 (0)3528 4386 845

Website: [www.baumer.com](http://www.baumer.com)

E-mail: [support.cameras@baumer.com](mailto:support.cameras@baumer.com)

## Target group for this User's Guide

This User's Guide is aimed at experienced users, which want to integrate camera(s) into a vision system.

## Intended Use

The camera is used to capture images that can be transferred over a GigE interface (VCXG / .I / .I.XT / .PTP / .I.PTP) or a USB 3.0 interface (VCXU) to a PC.

## Classification of the safety instructions

In the User's Guide, the safety instructions are classified as follows:

### Notice

Gives helpful notes on operation or other general recommendations.



### Caution



Indicates a possibly dangerous situation. If the situation is not avoided, slight or minor injury could result or the device may be damaged.



### Danger!



Indicates an immediate imminent danger. If the danger is not avoided, the consequences are death or very serious injury.

## Transport / Storage

Transport the camera only in the original packaging. When the camera is not installed, then storage the camera in original packaging.

## Disposal



Dispose of outdated products with electrical or electronic circuits, not in the normal domestic waste, but rather according to your national law and the directives 2002/96/EC and 2006/66/EC for recycling within the competent collectors.



Through the proper disposal of obsolete equipment will help to save valuable resources and prevent possible adverse effects on human health and the environment.

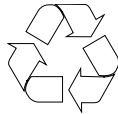

The return of the packaging to the material cycle helps conserve raw materials and reduces the production of waste. When no longer required, dispose of the packaging materials in accordance with the local regulations in force.

Keep the original packaging during the warranty period in order to be able to pack the device properly in the event of a warranty claim.

## Warranty Notes

If it is obvious that the device is / was dismantled, reworked or repaired by other than Baumer technicians, Baumer Optronic will not take any responsibility for the subsequent performance and quality of the device!

## Copyright

Any duplication or reprinting of this documentation, in whole or in part, and the reproduction of the illustrations even in modified form is permitted only with the written approval of Baumer. The information in this document is subject to change without notice.

## 1.1 Software Licensing Information

The software in the camera includes the LWIP TCP/IP implementation. The copyright information for this implementation is as follows:

Copyright (c) 2001, 2002 Swedish Institute of Computer Science. All rights reserved.

Redistribution and use in source and binary forms, with or without modification, are permitted provided that the following conditions are met:

1. Redistributions of source code must retain the above copyright notice, this list of conditions and the following disclaimer.
2. Redistributions in binary form must reproduce the above copyright notice, this list of conditions and the following disclaimer in the documentation and/or other materials provided with the distribution.
3. The name of the author may not be used to endorse or promote products derived from this software without specific prior written permission.

THIS SOFTWARE IS PROVIDED BY THE AUTHOR ``AS IS" AND ANY EXPRESS OR IMPLIED WARRANTIES, INCLUDING, BUT NOT LIMITED TO, THE IMPLIED WARRANTIES OF MERCHANTABILITY AND FITNESS FOR A PARTICULAR PURPOSE ARE DISCLAIMED.

IN NO EVENT SHALL THE AUTHOR BE LIABLE FOR ANY DIRECT, INDIRECT, INCIDENTAL, SPECIAL, EXEMPLARY, OR CONSEQUENTIAL DAMAGES (INCLUDING, BUT NOT LIMITED TO, PROCUREMENT OF SUBSTITUTE GOODS OR SERVICES; LOSS OF USE, DATA, OR PROFITS; OR BUSINESS INTERRUPTION) HOWEVER CAUSED AND ON ANY THEORY OF LIABILITY, WHETHER IN CONTRACT, STRICT LIABILITY, OR TORT (INCLUDING NEGLIGENCE OR OTHERWISE) ARISING IN ANY WAY OUT OF THE USE OF THIS SOFTWARE, EVEN IF ADVISED OF THE POSSIBILITY OF SUCH DAMAGE.

The software in the camera includes the ptpd implementation. The copyright information for this implementation is as follows:

Copyright (c) 2015	Wojciech Owczarek.
Copyright (c) 2014	Perseus Telecom.
Copyright (c) 2013-2014	Harlan Stenn, George N. Neville-Neil, Wojciech Owczarek, Jan Breuer.
Copyright (c) 2011-2012	George V. Neville-Neil, Steven Kreuzer, Martin Burnicki, Jan Breuer, Wojciech Owczarek, Gael Mace, Alexandre Van Kempen, Inaqui Delgado, Rick Ratzel, National Instruments.

Copyright (c) 2009-2010

George V. Neville-Neil,  
Steven Kreuzer,  
Martin Burnicki,  
Jan Breuer,  
Gael Mace,  
Alexandre Van Kempen.

Copyright (c) 2005-2008

Kendall Correll, Aidan Williams

All Rights Reserved

Redistribution and use in source and binary forms, with or without modification, are permitted provided that the following conditions are met:

1. Redistributions of source code must retain the above copyright notice this list of conditions and the following disclaimer.
2. Redistributions in binary form must reproduce the above copyright notice, this list of conditions and the following disclaimer in the documentation and/or other materials provided with the distribution.

THIS SOFTWARE IS PROVIDED BY THE AUTHORS ``AS IS" AND ANY EXPRESS OR IMPLIED WARRANTIES, INCLUDING, BUT NOT LIMITED TO, THE IMPLIED WARRANTIES OF MERCHANTABILITY AND FITNESS FOR A PARTICULAR PURPOSE ARE DISCLAIMED. IN NO EVENT SHALL THE AUTHORS OR CONTRIBUTORS BE LIABLE FOR ANY DIRECT, INDIRECT, INCIDENTAL, SPECIAL, EXEMPLARY, OR CONSEQUENTIAL DAMAGES (INCLUDING, BUT NOT LIMITED TO, PROCUREMENT OF SUBSTITUTE GOODS OR SERVICES; LOSS OF USE, DATA, OR PROFITS; OR BUSINESS INTERRUPTION) HOWEVER CAUSED AND ON ANY THEORY OF LIABILITY, WHETHER IN CONTRACT, STRICT LIABILITY, OR TORT (INCLUDING NEGLIGENCE OR OTHERWISE) ARISING IN ANY WAY OUT OF THE USE OF THIS SOFTWARE, EVEN IF ADVISED OF THE POSSIBILITY OF SUCH DAMAGE.



## 2. General Safety Instructions



### Caution

Heat can damage the camera. Provide adequate dissipation of heat, to ensure that the temperature does not exceed the value (see Heat Transmission).



As there are numerous possibilities for installation, Baumer recommends no specific method for proper heat dissipation, but suggest the following principles:

- operate the cameras only in mounted condition
- mounting in combination with forced convection may provide proper heat dissipation



### Caution



Observe precautions for handling electrostatic sensitive devices!









### Caution



The camera is a class A device (DIN EN 55022:2011). It can cause radio interference in residential environments. Should this happen, you must take reasonable measures to eliminate the interference.

### 3. Camera Models

All Baumer cameras of these family are characterized by:

Best image quality	▪ Low noise and structure-free image information												
Flexible image acquisition	▪ Industrially-compliant process interface with parameter setting capability												
Fast image transfer	<table border="0"> <tr> <td style="vertical-align: top;">VCXG/.XC/.I</td> <td>▪ Reliable transmission up to 1000 Mbit/sec according to IEEE802.3</td> </tr> <tr> <td style="vertical-align: top;">.I.XT/PTP/</td> <td>▪ Cable length up to 100 m</td> </tr> <tr> <td style="vertical-align: top;">.I.PTP</td> <td>▪ PoE (Power over Ethernet)</td> </tr> <tr> <td></td> <td>▪ Baumer driver for high data volume with low CPU load</td> </tr> <tr> <td></td> <td>▪ High-speed multi-camera operation</td> </tr> <tr> <td></td> <td>▪ GenICam™ and GigE Vision® compliant</td> </tr> </table>	VCXG/.XC/.I	▪ Reliable transmission up to 1000 Mbit/sec according to IEEE802.3	.I.XT/PTP/	▪ Cable length up to 100 m	.I.PTP	▪ PoE (Power over Ethernet)		▪ Baumer driver for high data volume with low CPU load		▪ High-speed multi-camera operation		▪ GenICam™ and GigE Vision® compliant
VCXG/.XC/.I	▪ Reliable transmission up to 1000 Mbit/sec according to IEEE802.3												
.I.XT/PTP/	▪ Cable length up to 100 m												
.I.PTP	▪ PoE (Power over Ethernet)												
	▪ Baumer driver for high data volume with low CPU load												
	▪ High-speed multi-camera operation												
	▪ GenICam™ and GigE Vision® compliant												
	<table border="0"> <tr> <td style="vertical-align: top;">VCXG.XC</td> <td>▪ internal cool pipes for cooling air</td> </tr> </table>	VCXG.XC	▪ internal cool pipes for cooling air										
VCXG.XC	▪ internal cool pipes for cooling air												
	<table border="0"> <tr> <td style="vertical-align: top;">VCXU</td> <td>▪ Reliable transmission at 5000 Mbit/sec according to USB 3.0 (v1.0.1) standard</td> </tr> <tr> <td></td> <td>▪ GenICam™ and USB3 Vision™ compliant</td> </tr> </table>	VCXU	▪ Reliable transmission at 5000 Mbit/sec according to USB 3.0 (v1.0.1) standard		▪ GenICam™ and USB3 Vision™ compliant								
VCXU	▪ Reliable transmission at 5000 Mbit/sec according to USB 3.0 (v1.0.1) standard												
	▪ GenICam™ and USB3 Vision™ compliant												
Perfect integration	<ul style="list-style-type: none"> <li>▪ Flexible generic programming interface (Baumer GAPI) for all Baumer cameras</li> <li>▪ Powerful Software Development Kit (SDK) with sample codes and help files for simple integration</li> <li>▪ Baumer viewer for all camera functions</li> <li>▪ GenICam™ compliant XML file to describe the camera functions</li> <li>▪ Supplied with installation program with automatic camera recognition for simple commissioning</li> </ul>												
Compact design	<ul style="list-style-type: none"> <li>▪ Light weight</li> <li>▪ flexible assembly</li> </ul>												
Reliable operation	<ul style="list-style-type: none"> <li>▪ State-of-the-art camera electronics and precision mechanics</li> <li>▪ Low power consumption and minimal heat generation</li> </ul>												
Supported standards	<table border="0"> <tr> <td style="vertical-align: top;">VCXG</td> <td>▪ GenICam™ SFNC 2.1   Rel. 2.0: SFNC 2.3   Rel. 3.0: SFNC 2.4   Rel. 4.0: SNFC 2.4</td> </tr> <tr> <td></td> <td>▪ IEEE 1588™-2008 (only .PTP / .I.PTP)</td> </tr> <tr> <td style="vertical-align: top;">VCXU</td> <td>▪ USB3 Vision™ 1.0.1</td> </tr> <tr> <td></td> <td>▪ GenICam™ GenCP 1.1</td> </tr> <tr> <td></td> <td>▪ GenICam™ SFNC 2.1   Rel. 2.0: SFNC 2.3   Rel. 3.0: SFNC 2.4</td> </tr> </table>	VCXG	▪ GenICam™ SFNC 2.1   Rel. 2.0: SFNC 2.3   Rel. 3.0: SFNC 2.4   Rel. 4.0: SNFC 2.4		▪ IEEE 1588™-2008 (only .PTP / .I.PTP)	VCXU	▪ USB3 Vision™ 1.0.1		▪ GenICam™ GenCP 1.1		▪ GenICam™ SFNC 2.1   Rel. 2.0: SFNC 2.3   Rel. 3.0: SFNC 2.4		
VCXG	▪ GenICam™ SFNC 2.1   Rel. 2.0: SFNC 2.3   Rel. 3.0: SFNC 2.4   Rel. 4.0: SNFC 2.4												
	▪ IEEE 1588™-2008 (only .PTP / .I.PTP)												
VCXU	▪ USB3 Vision™ 1.0.1												
	▪ GenICam™ GenCP 1.1												
	▪ GenICam™ SFNC 2.1   Rel. 2.0: SFNC 2.3   Rel. 3.0: SFNC 2.4												
Conformity	<table border="0"> <tr> <td style="vertical-align: top;">CE</td> <td>We declare, under our sole responsibility, that the described Baumer cameras conform with the directives of the CE.</td> <td style="vertical-align: middle; text-align: right;"></td> </tr> <tr> <td style="vertical-align: top;">KC</td> <td>Several of the described Baumer VCX cameras conform with the directives of the Korean Conformity.</td> <td style="vertical-align: middle; text-align: right;"></td> </tr> </table> <p>(see table on next page)</p>	CE	We declare, under our sole responsibility, that the described Baumer cameras conform with the directives of the CE.		KC	Several of the described Baumer VCX cameras conform with the directives of the Korean Conformity.							
CE	We declare, under our sole responsibility, that the described Baumer cameras conform with the directives of the CE.												
KC	Several of the described Baumer VCX cameras conform with the directives of the Korean Conformity.												

**Korean Conformity (Registration of Broadcasting and Communication Equipments)**

**VCXG**

Product	Article No.	Registration No.	Date of Registration
<b>Monochrome</b>			
VCXG-02M	11165842	MSIP-REI-BkR-VCXG-13M	2017-05-02
VCXG-13M	11164973	MSIP-REI-BkR-VCXG-13M	2017-05-02
VCXG-23M	11165941	R-R-BkR-VCXG-23C	2021-05-13
VCXG-24M	11165944	R-R-BkR-VCXG-23C	2021-05-13
VCXG-25M	11165829	MSIP-REI-BkR-VCXG-53M	2017-05-02
VCXG-32M	11165949	MSIP-REI-BkR-VCXG-51C	2017-05-02
VCXG-51M	11165952	MSIP-REI-BkR-VCXG-51C	2017-05-02
VCXG-53M	11151554	MSIP-REI-BkR-VCXG-53M	2017-05-02
VCXG-91M	11173890	MSIP-REI-BkR-VCXG-124M	2017-05-02
VCXG-124M	11172630	MSIP-REI-BkR-VCXG-124M	2017-05-02
VCXG-201M.R	11194343	R-REI-BkR-VCXG-201MR	2018-07-10
<b>Color</b>			
VCXG-02C	11165843	MSIP-REI-BkR-VCXG-13M	2017-05-02
VCXG-13C	11164974	MSIP-REI-BkR-VCXG-13M	2017-05-02
VCXG-23C	11165942	R-R-BkR-VCXG-23C	2021-05-13
VCXG-24C	11165943	R-R-BkR-VCXG-23C	2021-05-13
VCXG-25C	11165828	MSIP-REI-BkR-VCXG-53M	2017-05-02
VCXG-32C	11165950	MSIP-REI-BkR-VCXG-51C	2017-05-02
VCXG-51C	11165953	MSIP-REI-BkR-VCXG-51C	2017-05-02
VCXG-53C	11151555	MSIP-REI-BkR-VCXG-53M	2017-05-02
VCXG-91C	11173819	MSIP-REI-BkR-VCXG-124M	2017-05-02
VCXG-124C	11172609	MSIP-REI-BkR-VCXG-124M	2017-05-02
VCXG-201C.R	11172631	R-REI-BkR-VCXG-201MR	2018-07-10

**VCXG.I / .XT / .PTP**

Product	Article No.	Registration No.	Date of Registration
<b>Monochrome</b>			
VCXG-32M.I	11186791	R-R-BkR-VCXG-51MI	2020-12-24
VCXG-32M.I.PTP	11217696	R-R-BkR-VCXG-51MI	2020-12-24
VCXG-32M.I.XT	11188950	R-R-BkR-VCXG-51MI	2020-12-24
VCXG-51M.I	11186793	R-R-BkR-VCXG-51MI	2020-12-24
VCXG-51M.I.PTP	11217699	R-R-BkR-VCXG-51MI	2020-12-24
VCXG-51M.I.XT	11188955	R-R-BkR-VCXG-51MI	2020-12-24
<b>Color</b>			
VCXG-32C.I	11186790	R-R-BkR-VCXG-51MI	2020-12-24
VCXG-32C.I.PTP	11217697	R-R-BkR-VCXG-51MI	2020-12-24
VCXG-32C.I.XT	11188951	R-R-BkR-VCXG-51MI	2020-12-24
VCXG-51C.I	11186792	R-R-BkR-VCXG-51MI	2020-12-24
VCXG-51C.I.PTP	11217698	R-R-BkR-VCXG-51MI	2020-12-24
VCXG-51C.I.XT	11188952	R-R-BkR-VCXG-51MI	2020-12-24

## VCXU

Product	Article No.	Registration No.	Date of Registration
<b>Monochrome</b>			
VCXU-02M	11165914	MSIP-REI-BkR-VCXU13M	2017-04-18
VCXU-13M	11165908	MSIP-REI-BkR-VCXU13M	2017-04-18
VCXU-25M	11165905	R-R-BkR-VCXU-53M	2020-12-08
VCXU-31M	11165812	MSIP-REI-BkR-VCXU-50M	2017-04-28
VCXU-50M	11151564	MSIP-REI-BkR-VCXU-50M	2017-04-28
VCXU-51M	11164500	MSIP-REI-BkR-VCXU-50M	2017-04-28
VCXU-53M	11165900	R-R-BkR-VCXU-53M	2020-12-08
<b>Color</b>			
VCXU-02C	11165913	MSIP-REI-BkR-VCXU13M	2017-04-18
VCXU-13C	11165907	MSIP-REI-BkR-VCXU13M	2017-04-18
VCXU-25C	11165903	R-R-BkR-VCXU-53M	2020-12-08
VCXU-31C	11165813	MSIP-REI-BkR-VCXU-50M	2017-04-28
VCXU-50C	11151566	MSIP-REI-BkR-VCXU-50M	2017-04-28
VCXU-51C	11164501	MSIP-REI-BkR-VCXU-50M	2017-04-28
VCXU-53C	11165901	R-R-BkR-VCXU-53M	2020-12-08

## Release Version

### Notice

#### Identification of Release version

- Label on camera ("R2.0" is Release 2.0)
- Baumer GAPI 2.x Camera Explorer / Category: *Device Control* → *Device Version* (Release 1: R1.x.x / Release 2: R2.x.x)

### 3.1 VCXG / .PTP

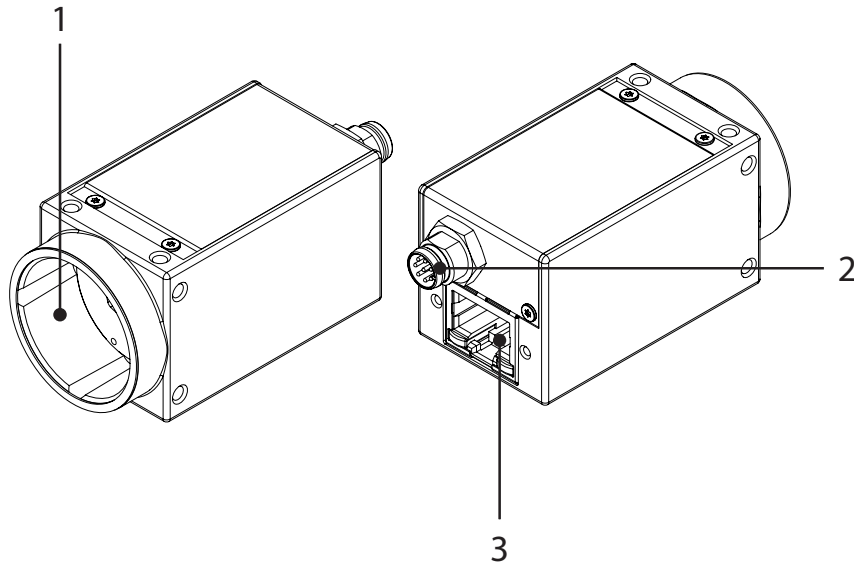

No.	Description	No.	Description
1	Lens mount (C-Mount)	3	Ethernet Port (PoE) / Signaling LED's
2	Power supply / Digital-I/O		

Camera Type	Sensor Size	Resolution	Full Frames <sup>1)</sup> [max. fps]
<b>Monochrome / Color</b>			
VCXG-02M / VCXG-02C	1/4"	640 × 480	595   403
VCXG-04M / VCXG-04C	1/2.9"	720 × 540	439.5   318
VCXG-13M / VCXG-13C	1/2"	1280 × 1024	145   94
VCXG-13NIR	1/2"	1280 × 1024	145   94
VCXG-15M / VCXG-15C	1/1.8"	1440 × 1080	120   79
VCXG-22M.R / VCXG-22C.R	1/2"	1920 × 1080	89   60
VCXG-23M / VCXG-23C	1/1.2"	1920 × 1200	81.5   53.5
VCXG-24M / VCXG-24C	1/1.2"	1920 × 1200	38.5
VCXG-25M / VCXG-25C	2/3"	1920 × 1200	59   53
VCXG-32M / VCXG-32C	1/1.8"	2048 × 1536	55.5   39.5
VCXG-32M.PTP / VCXG-32C.PTP	1/1.8"	2048 × 1536	55.5   39.5
VCXG-50MP	2/3"	2448 × 2048	36   24
VCXG-51M / VCXG-51C	2/3"	2448 × 2048	35.5   23.5
VCXG-51M.PTP / VCXG-51C.PTP	2/3"	2448 × 2048	35.5   23.5
VCXG-53M / VCXG-53C	1"	2592 × 2048	28   23.5
VCXG-53NIR	1"	2592 × 2048	28   23.5
VCXG-82M / VCXG-82C	2/3"	2848 × 2832	15   15
VCXG-65M.R / VCXG-65C.R	1/1.8"	3072 × 2048	29   16
VCXG-91M / VCXG-91C	1"	4096 × 2160	21   13
VCXG-124M / VCXG-124C	1.1"	4096 × 3000	15   10
VCXG-124M.PTP / VCXG-124C.PTP	1.1"	4096 × 3000	15   10
VCXG-125M.R / VCXG-125C.R	1/1.9"	4000 × 3000	15   10
VCXG-127M / VCXG-127C	1/1.1"	4096 × 2992	10   10
VCXG-201M.R / VCXG-201C.R	1"	5472 × 3648	9   6
VCXG-204M / VCXG-204C	1/1.1"	4480 × 4496	6   6
VCXG-241M	1.2"	5312 × 4600   4592 <sup>2)</sup>	5   5
VCXG-241C		5312 × 4592	

<sup>1)</sup> Burst Mode (image acquisition in the camera's internal memory)

<sup>2)</sup> ≥ Rel. 4.0

## Dimensions

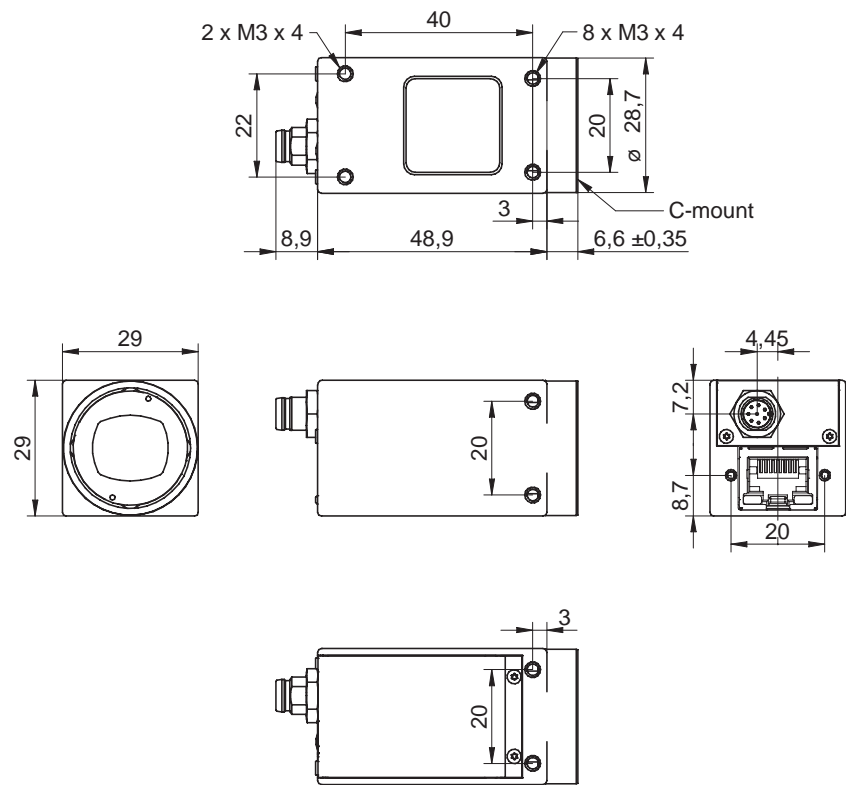

### 3.2 VCXG.XC

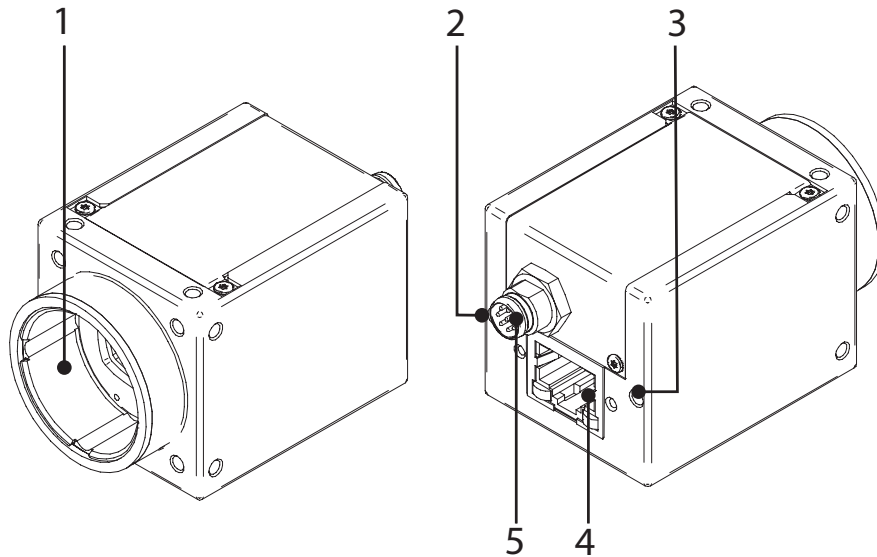

No.	Description	No.	Description
1	Lens mount (C-Mount)	4	Ethernet Port (PoE) / Signaling LED's
2	Cooling pipe intake	5	Power supply / Digital-I/O
3	Cooling pipe outlet		

Camera Type	Sensor Size	Resolution	Full Frames <sup>1)</sup> [max. fps]
<b>Monochrome</b>			
VCXG-14SWIR.XC	1/2"	1296 × 1032	71   71
VCXG-51M.XC	2/3"	2448 × 2048	35.5   23.5

#### Dimensions

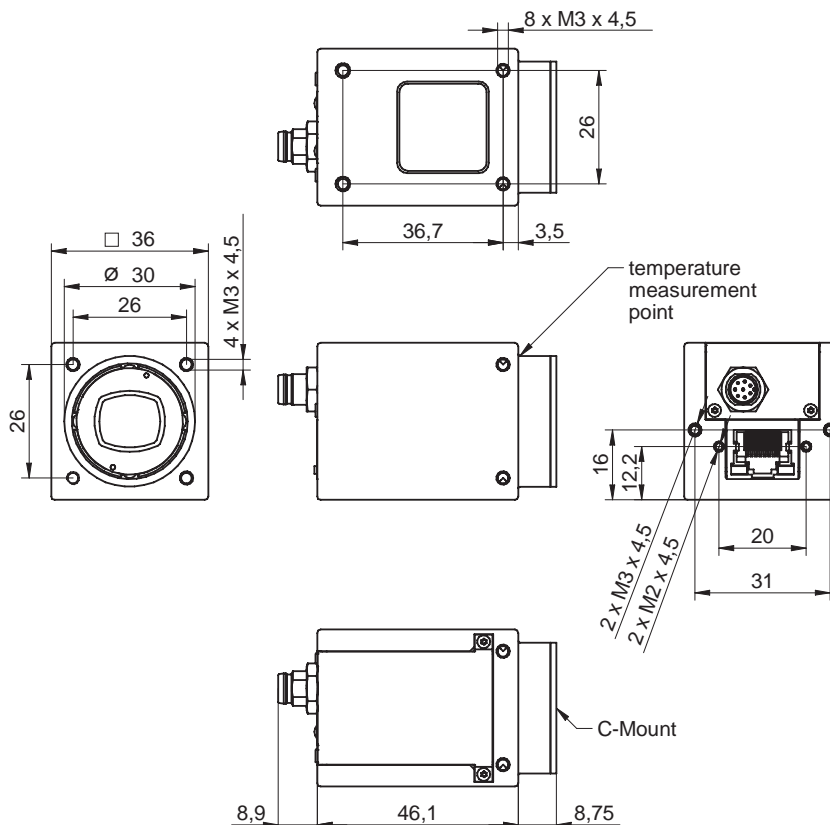

**Notice**  
**VCXG-14SWIR.XC**  
 Dual Use Classification (ECCN/AL: 6A003B)  
 This product is subject to statutory export control regulations and may require written information on intended end use and final destination!

<sup>1)</sup> Burst Mode (image acquisition in the camera's internal memory) | interface

### 3.3 VCXG.I / .XT / .PTP

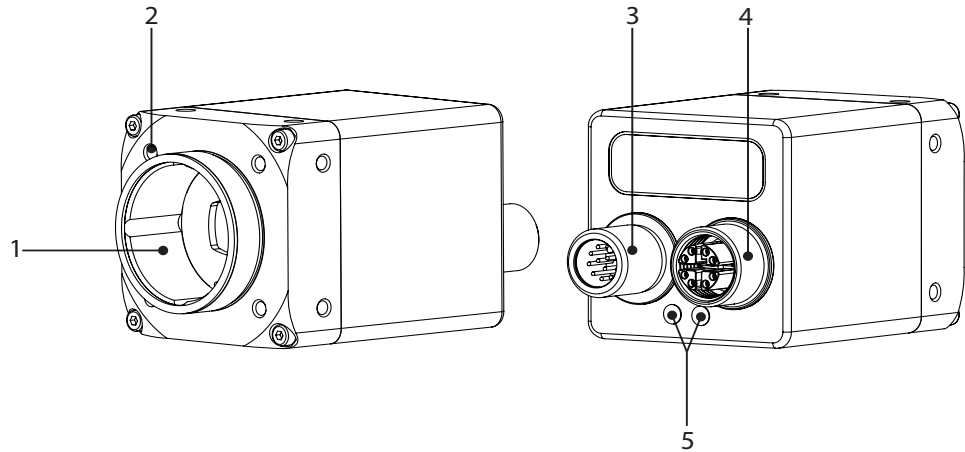

No.	Description	No.	Description
1	Lens mount (C-Mount)	4	Ethernet Port (PoE)
2	4 x Tube Adapter / front mounting threads	5	GigE Signaling LED's
3	Power supply / Digital-IO		

Camera Type	Sensor Size	Resolution	Full Frames <sup>1)</sup> [max. fps]
<b>Monochrome / Color</b>			
VCXG-13M.I / .XT / VCXG-13C.I / .XT	1/2"	1280 × 1024	145   94
VCXG-15M.I / .XT / VCXG-15C.I / .XT	1/2.9"	1140 × 1080	121   79
VCXG-25M.I / .XT / VCXG-25C.I / .XT	2/3"	1920 × 1200	59   53
VCXG-32M.I / .XT / VCXG-32C.I / .XT	1/1.8"	2048 × 1536	55.5   39.5
VCXG-32M.I.PTP / VCXG-32C.I.PTP	1/1.8"	2048 × 1536	55.5   39.5
VCXG-51M.I / .XT / VCXG-51C.I / .XT	2/3"	2448 × 2048	35.5   23.5
VCXG-51M.I.PTP / VCXG-51C.I.PTP	2/3"	2448 × 2048	35.5   23.5
VCXG-53M.I / .XT / VCXG-53C.I / .XT	1"	2592 × 2048	28   23.5
VCXG-82M.I / .XT / VCXG-82C.I / .XT	2/3"	2848 × 2832	15   15
VCXG-124M.I / .XT / VCXG-124C.I / .XT	1.1"	4096 × 3000	15   10
VCXG-124M.I.PTP / VCXG-124C.I.PTP	1.1"	4096 × 3000	15   10
VCXG-127M.I / .XT / VCXG-127C.I.XT	1/1.1"	4096 × 2992	10   10
VCXG-201M.R.I / .XT / VCXG-201C.R.I / .XT	1"	5472 × 3648	6   9
VCXG-241M.I / .XT / VCXG-241C.I / .XT	1.2"	5312 × 4592	5   5

<sup>1)</sup> Burst Mode (image acquisition in the camera's internal memory) | interface



## Dimensions

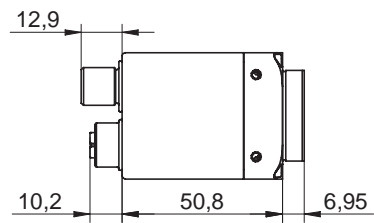
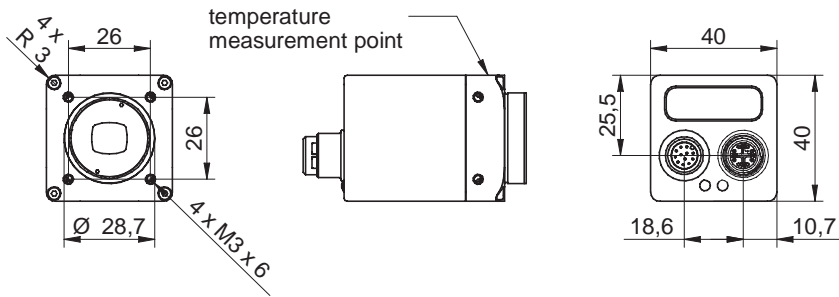
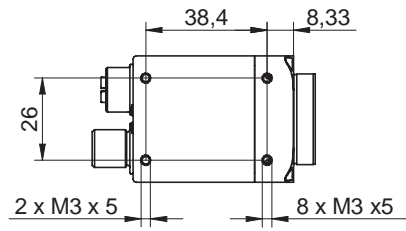

## Modular tube system (ordered separately)

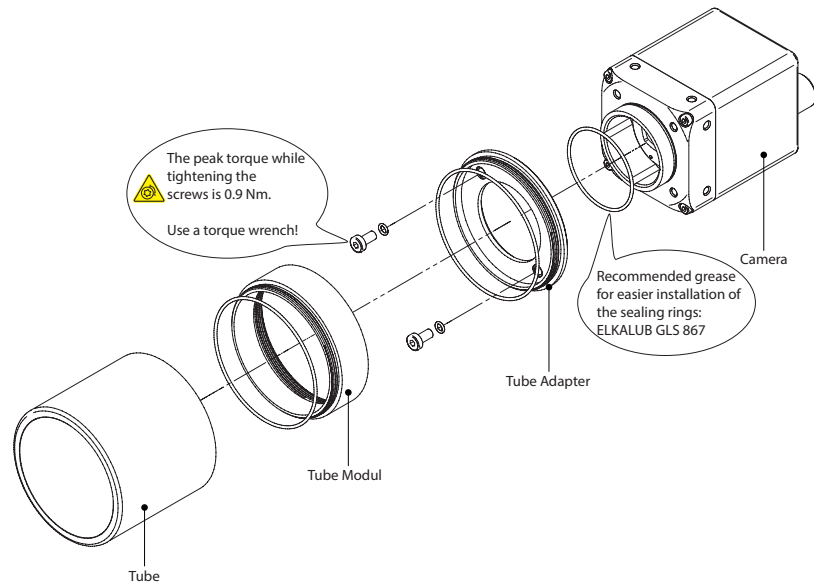

## Tube Adapter

**M 47**

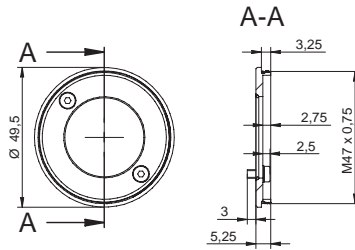

**M 62**

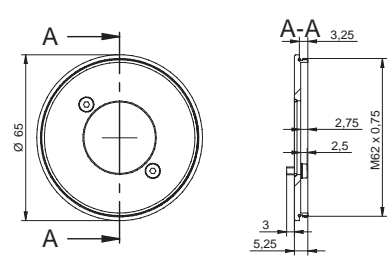

**M 92**

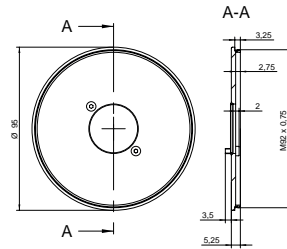

Distance Ring

**M 47**

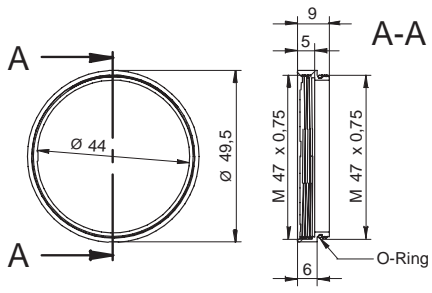

Art. No.: 11185372

**M 62**

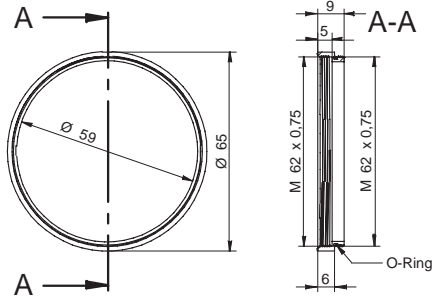

Art. No.: 11185376

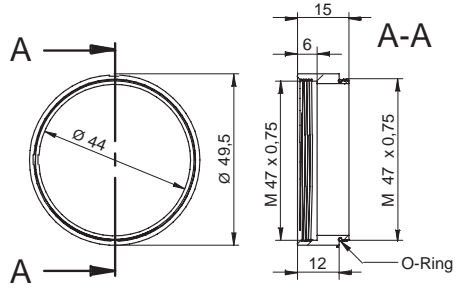

Art. No.: 11185371

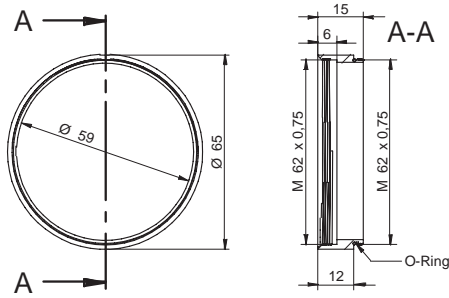

Art. No.: 11185375

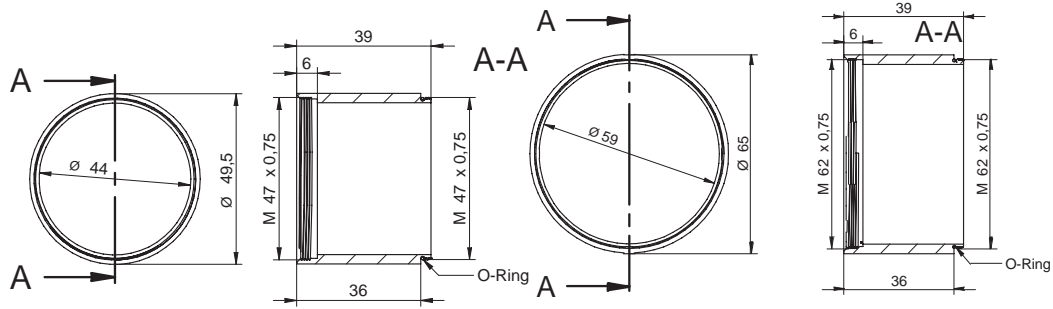

Art. No.: 11211571

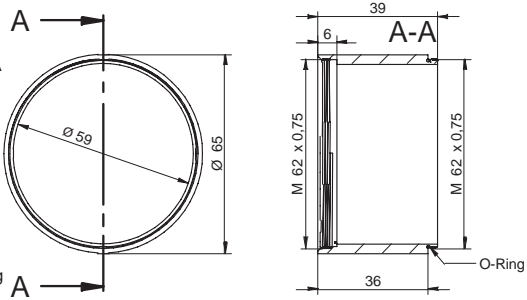

Art. No.: 11198906

M 92

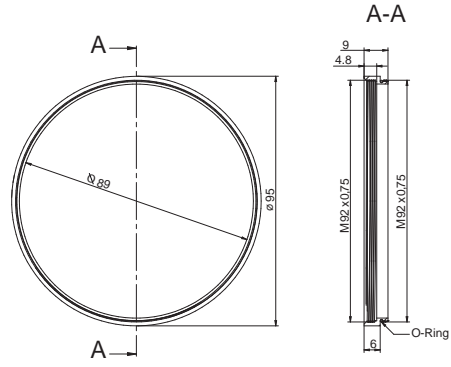

Art. No.: 11704395

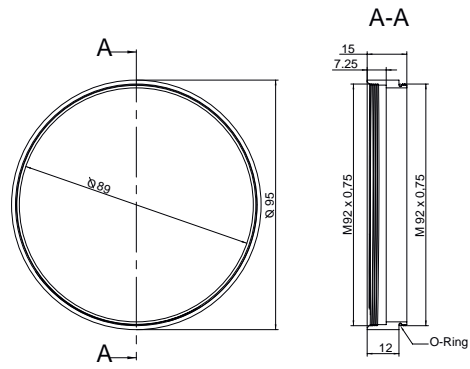

Art. No.: 11704397

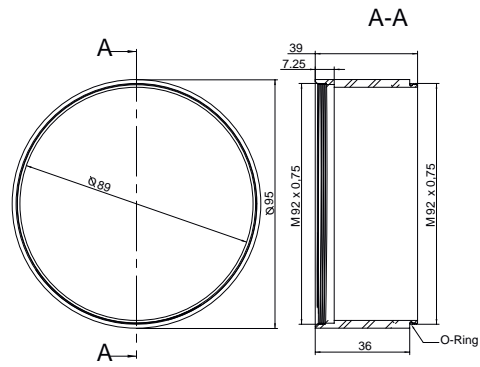

Art. No.: 11704394

**Tube**

**M 47**

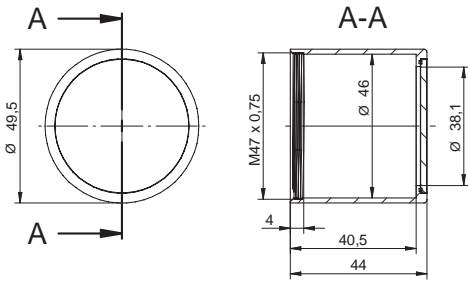

Art. No.: 11185370 (Cover Glass: Acryl)

Art. No.: 11195425 (Cover Glass: resistant laminated safety cover glass)

**M 62**

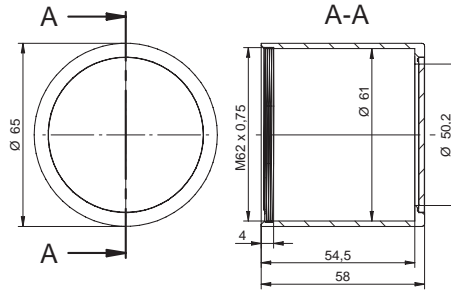

Art. No.: 11185374 (Cover Glass: Acryl)

Art. No.: 11195426 (Cover Glass: resistant laminated safety cover glass)

**M 92**

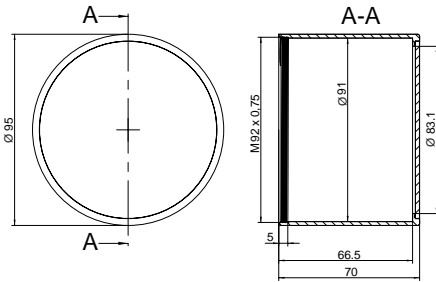

Art. No.: 11704312 / Cover glass: PMMA (Acryl)

**Inner dimensions of the Tube**

**M 47**

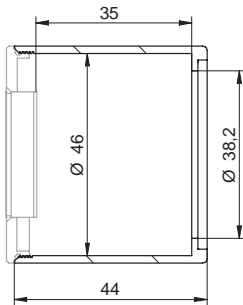

**M 62**

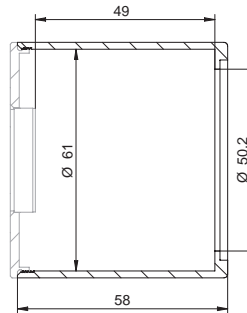

**M 92**

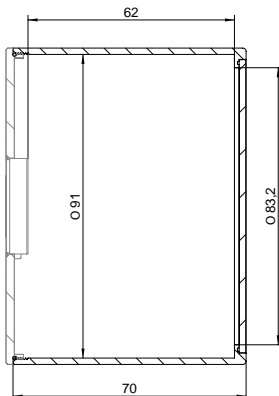

### 3.4 VCXU

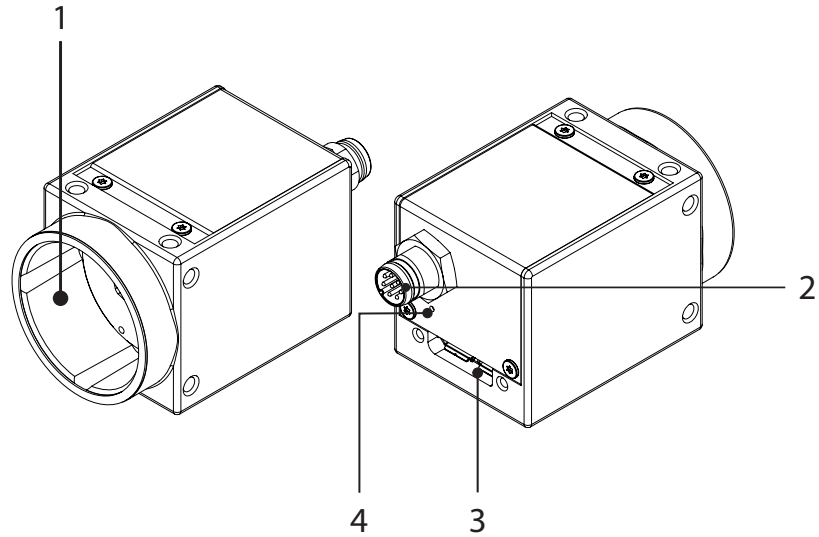

No.	Description	No.	Description
1	Lens mount (C-Mount)	3	USB 3.0 port
2	Digital-I/O	4	Signaling-LED

Camera Type	Sensor Size	Resolution	Full Frames [max. fps]
<b>Monochrome / Color</b>			
VCXU-02M / VCXU-02C	1/4"	640 × 480	891
VCXU-04M / VCXU-04C	1/2.9"	720 × 540	430
VCXU-13M / VCXU-13C	1/2"	1280 × 1024	222
VCXU-15M / VCXU-15C	1/2.9"	1440 × 1080	225
VCXU-22M.R / VCXU-22C.R	1/2"	1920 × 1080	138
VCXU-23M / VCXU-23C	1/1.2"	1920 × 1200	165
VCXU-24M / VCXU-24C	1/1.2"	1920 × 1200	38
VCXU-25M / VCXU-25C	2/3"	1920 × 1200	167
VCXU-31M / VCXU-31C	1/1.8"	2048 × 1536	120
VCXU-32M / VCXU-32C	1/1.8"	2048 × 1536	55.5
VCXU-50M / VCXU-50C	2/3"	2448 × 2048	73
VCXU-50MP	2/3"	2448 × 2048	73
VCXU-51M / VCXU-51C	2/3"	2448 × 2048	35
VCXU-53M / VCXU-53C	1"	2592 × 2048	73.5
VCXU-65M.R / VCXU-65C.R	1/1.8"	3072 × 2048	47
VCXU-90M / VCXU-90C	1"	4096 × 2160	41
VCXU-91M / VCXU-91C	1"	4096 × 2160	32
VCXU-123M / VCXU-123C	1.1"	4096 × 3000	31
VCXU-124M / VCXU-124C	1.1"	4096 × 3000	29
VCXU-125M.R / VCXU-125C.R	1/1.9"	4000 × 3000	29
VCXU-201M.R / VCXU-201C.R	1"	5472 × 3648	15

## Dimensions

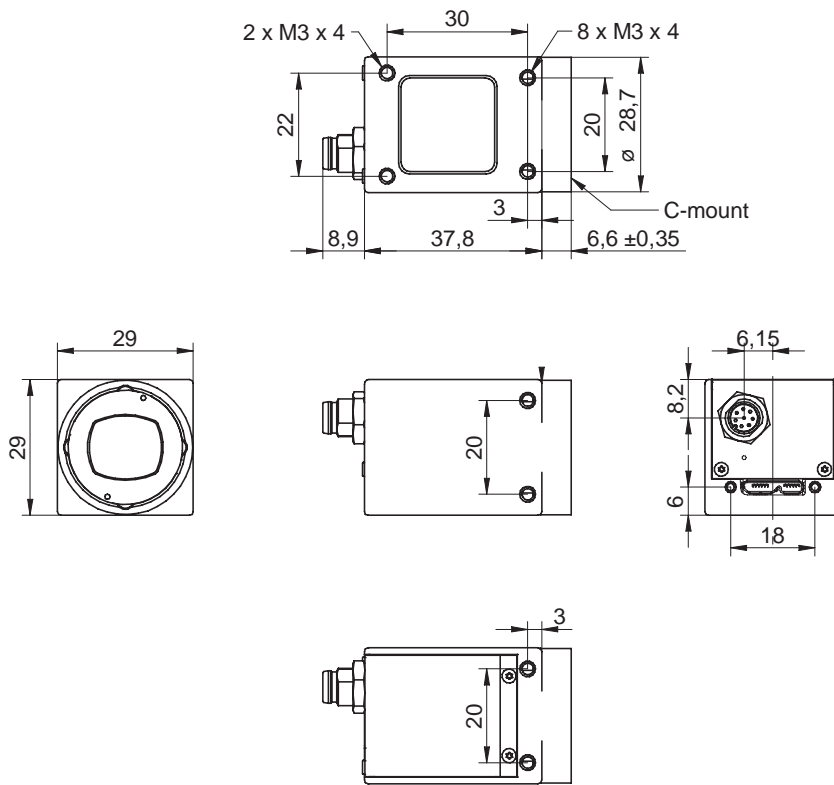

## 4. Installation

### 4.1 Environmental Requirements

Storage temperature	VCXG	-10 °C (+14 °F) ... +70 °C (+158 °F)
	VCXU	-10 °C (+14 °F) ... +70 °C (+158 °F)
	VCXG.XC	-10 °C (+14 °F) ... +70 °C (+158 °F)
	VCXG.I	-10 °C (+14 °F) ... +70 °C (+158 °F)
	VCXG.I.PTP	-10 °C (+14 °F) ... +70 °C (+158 °F)
	VCXG.I.XT	-40 °C (-40 °F) / -30 °C <sup>2)</sup> (-22 °F) ... +70 °C (+158 °F)
Operating temperature	VCXG	0 °C (41 °F) ... 60 °C (140 °F) <sup>1)</sup> */** / 65 °C (149 °F)*/**
	VCXU	0 °C (41 °F) ... 60 °C (140 °F) <sup>1)</sup> */** / 65 °C (149 °F)*/**
	VCXG.XC	0 °C (32 °F) ... 65 °C (149 °F) */** / 75 °C (167 °F)*/**
	VCXG.I	0 °C (32 °F) ... 65 °C (149 °F)*/***
	VCXG.I.PTP	0 °C (32 °F) ... 65 °C (149 °F)*/***
	VCXG.I.XT	-40 °C (-40 °F) / -30 °C <sup>2)</sup> (-22 °F) ... 70 °C (158 °F)*/***
Humidity		10 % ... 90 % non condensing

<sup>1)</sup> VCXU-125M.R / C.R; VCXU-201M.R / C.R

<sup>2)</sup> VCXG-201M.R.I.XT / C.R.I.XT

The sensor specification ensures unrestricted use from an operating temperature greater than -10 °C (14 °F). Use at temperatures lower than -10 °C (14 °F) may result in disturbed image acquisition or poorer image quality.

\*/ at T (Measurement Point)

/\*\* Ambient temperature in the range above 28 °C (82.4 °F) / 34 °C (93.2 °F) / 32 °C (89.6 °F) / 39 °C (102.2 °F) (depending on camera model) requires heat dissipation measures.

/\*\*\* Ambient temperature above 45 °C (113 °F) requires heat dissipation measures.

#### Notice

##### Ambient temperature for UL applications

The maximum ambient temperature (all cameras) for UL applications is 40 °C (104 °F). Air flow (1 m/s) required in all temperature ranges.



## 4.2 Heat Transmission

**Notice**  
 The values for MTBF can be found in the respective Technical Data Sheet (TDS).

**⚠ Caution**

 Device heats up during operation.  
 Skin irritation possible.  
 Do not touch the camera during operation.

**⚠ Caution**

Heat can damage the camera. Provide adequate dissipation of heat, to ensure that the temperatures does not exceed the value (see table below).

As there are numerous possibilities for installation, Baumer recommends no specific method for proper heat dissipation, but suggest the following principles:



- operate the cameras only in mounted condition
- mounting in combination with forced convection may provide proper heat dissipation

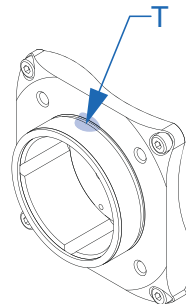
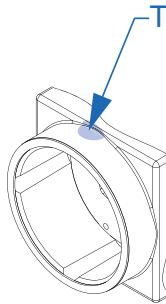

Temperature Measuring Point (T) Maximal Temperature			
VCXG / .XC / .R / .PTP	VCXU	VCXG.I / .PTP	VCXG.I.XT
65 °C (149 °F)	65 °C (149 °F) 60 °C (140 °F) <sup>1)</sup>	65 °C (149 °F)	70 °C (158 °F)

<sup>1)</sup> VCXU-125M.R/C.R; VCXU-201M.R/C.R

### Cooling pipe (VCXG.XC only)

The camera is equipped with an internal cooling pipe integrated into the housing. Compressed air / Tempering liquid can be passed through this cooling pipe to cool the camera.

For connecting the compressed air / Tempering liquid hoses (Cooling pipe intake / Cooling pipe outlet) use push-in fittings with male thread M3 and plastic tubing for compressed air or Tempering liquid, e.g. FESTO QSM-M3-3-I and FESTO PUN-H-3x0.5.

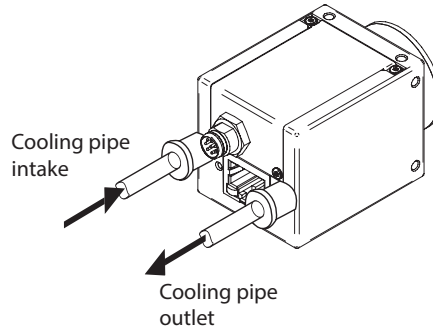

### Cooling with air

Camera is tested with compressed air at 3 bar pressure according to ISO 8573-1:2010 [1:4:2] [Particles:Water:Oil] A maximum pressure of 6 bar is permissible.

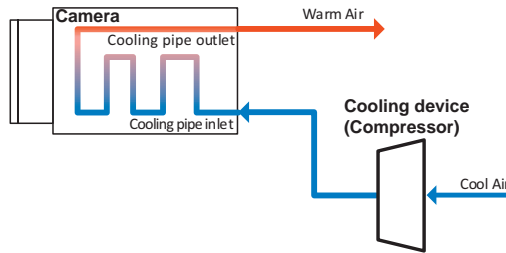

ISO 8573-12010 Compressed Air Contaminants and Purity Classes

Class	Particles				Water			Oil
	By Particle Size (maximum number of particles per m <sup>3</sup> )			By Mass	Vapor Dewpoint	Pressure	Liquid	Liquid, Aerosol & Vapor
	0.10 - 0.5 microns	0.5 - 1.0 microns	1.0 - 5.0 microns	mg/m <sup>3</sup>	°C	°F	g/m <sup>3</sup>	mg/m <sup>3</sup>
0	As specified by the equipment user or supplier and more stringent than class 1							
1	≤ 20,000	≤ 400	≤ 10	-	≤ -70	≤ -94	-	≤ 0.01
2	≤ 400,000	≤ 6,000	≤ 100	-	≤ -40	≤ -40	-	≤ 0.1
3	-	≤ 90,000	≤ 1,000	-	≤ -20	≤ -4	-	≤ 1
4	-	-	≤ 10,000	-	≤ +3	≤ +37	-	-
5	-	-	≤ 100,000	-	≤ +7	≤ +45	-	-
6	-	-	-	0 - ≤ 5	≤ +10	≤ +50	-	-
7	-	-	-	5 - ≤ 10	-	-	≤ 0.5	-
8	-	-	-	-	-	-	≤ 5	-
9	-	-	-	-	-	-	≤ 10	-
X	-	-	-	> 10	-	-	> 10	> 5

Comparison of temperature behavior without and with air cooling:

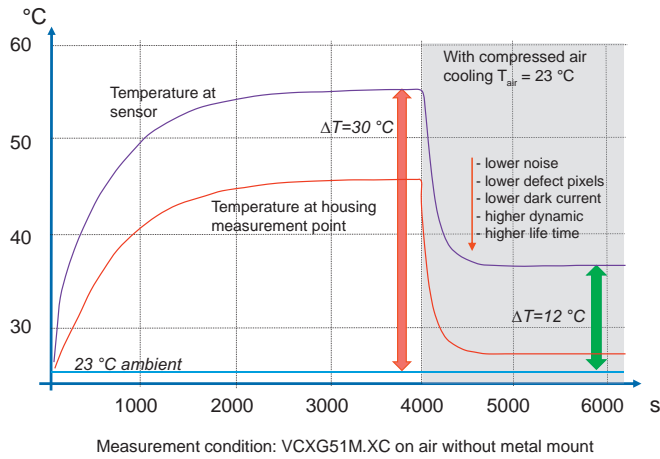

### Cooling with tempering liquid

The cooling with liquid efficiently transports heat from the camera.

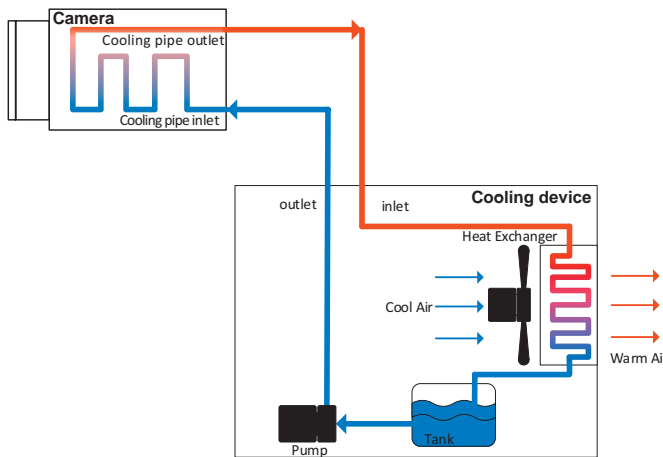

**⚠ Danger!**

Danger due to incorrect system components.

Risk of electric shock. Electric shock can be fatal or cause serious injury.

The system components, cables, connections for tempering liquid, hoses for tempering liquid and the objective must be selected according to the operating conditions.

An ambient temperature of +85 °C (185 °F) must not be exceeded for the camera and its components, as the connectors (RJ45 and M8) are specified up to this temperature. At temperatures below freezing, make sure that the tempering liquid supply is not interrupted.

The tempering liquid must meet the following criteria:

- compatible with aluminum
- must contain bio-growth inhibitors
- must contain corrosion protection
- maximum pressure 6 bar
- Temperature range of liquid is recommended between: 1 .. 50 °C (depending on the ambient temperature)
- The camera was tested with a flow rate of 0,9l / h. The flow rate depends on the pump capacity used.

We recommend the water bath protective media "Aqua Stabil" from Julabo.

#### 4.2.1 Emergency shutdown at Overtemperature ( $\geq$ Rel. 2 only)

To prevent damage on the hardware due to high temperatures, the camera is equipped with an emergency shutdown. The *DeviceTemperatureStatusTransitionSelector* (Category: *Device Control*) feature allows you to select different thresholds for temperatures:

*NormalToHigh*: freely programmable value

*HighToExceeded*: fixed value (camera shutdown if exceeded)

*ExceededToNormal*: freely programmable value, temperature for error-free re-activation of the camera.

In the *DeviceTemperatureStatusTransition* feature, the temperatures for the programmable temperature transitions are set.

The *Event DeviceTemperatureStatusChanged* is always generated when *DeviceTemperatureStatus* changes.

If the temperature rises above the value set at *HighToExceed*, the *DeviceTemperatureExceeded* feature is set to *True*, the image recording is stopped, and the LED is set to red.

For further use, the camera must be disconnected from the power supply after cooling down or a device reset should be carried out.

The sufficient cooling is recognizable when the event *DeviceTemperatureStatus-Changed* (Device Temperature < *ExceededToNormal*) is output.

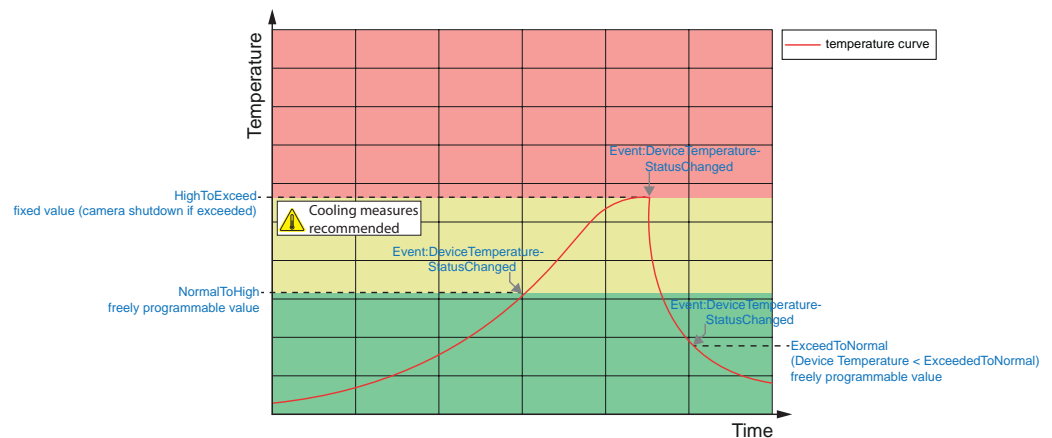

## Temperatures for emergency shutdown

When the temperature measurement at the internal temperature sensor gives a temperature exceeding the specified values in the following tables, the *DeviceTemperatureExceeded* feature is set to *True*, the image recording is stopped, and the LED is set to red.

### VCXG

Camera Type	max. Temperature (internal temperature sensor)
<b>Monochrome / Color</b>	
VCXG-02M / VCXG-02C	75 °C (167 °F)
VCXG-04M / VCXG-04C	75 °C (167 °F)
VCXG-13M / VCXG-13C	75 °C (167 °F)
VCXG-13NIR	75 °C (167 °F)
VCXG-15M / VCXG-15C	75 °C (167 °F)
VCXG-22M.R / VCXG-22C.R	72 °C (161.6 °F)
VCXG-23M / VCXG-23C	72 °C (161.6 °F)
VCXG-24M / VCXG-24C	72 °C (161.6 °F)
VCXG-25M / VCXG-25C	75 °C (167 °F)
VCXG-32M / VCXG-32C	72 °C (161.6 °F)
VCXG-50MP	75 °C (167 °F)
VCXG-51M / VCXG-51C	75 °C (167 °F)
VCXG-53M / VCXG-53C	75 °C (167 °F)
VCXG-53NIR	75 °C (167 °F)
VCXG-65M.R / VCXG-65C.R	72 °C (163.4 °F)
VCXG-82M / VCXG-82C	75 °C (167 °F)
VCXG-91M / VCXG-91C	75 °C (167 °F)
VCXG-124M / VCXG-124C	75 °C (167 °F)
VCXG-125M.R / VCXG-125C.R	75 °C (167 °F)
VCXG-127M / VCXG-127C	75 °C (167 °F)
VCXG-201M.R / VCXG-201C.R	75 °C (167 °F)
VCXG-204M / VCXG-204C	75 °C (167 °F)
VCXG-241M / VCXG-241C	75 °C (167 °F)

### VCXG.PTP

Camera Type	max. Temperature (internal temperature sensor)
<b>Monochrome / Color</b>	
VCXG-32M.PTP / VCXG-32C.PTP	70 °C (158 °F)
VCXG-51M.PTP / VCXG-51C.PTP	70 °C (158 °F)
VCXG-124M.PTP / VCXG-124C.PTP	70 °C (158 °F)

## VCXG.I

Camera Type	max. Temperature (internal temperature sensor)
<b>Monochrome / Color</b>	
VCXG-13M.I / VCXG-13C.I	70 °C (158 °F)
VCXG-15M.I / VCXG-15C.I	70 °C (158 °F)
VCXG-25M.I / VCXG-25C.I	70 °C (158 °F)
VCXG-32M.I / VCXG-32C.I	70 °C (158 °F)
VCXG-51M.I / VCXG-51C.I	70 °C (158 °F)
VCXG-53M.I / VCXG-53C.I	70 °C (158 °F)
VCXG-82M.I / VCXG-82C.I	75 °C (167 °F)
VCXG-124M.I / VCXG-124C.I	70 °C (158 °F)
VCXG-127M.I / VCXG-127C.I	75 °C (167 °F)
VCXG-201M.R.I / VCXG-201C.R.I	75 °C (167 °F)
VCXG-241M.I / VCXG-241C.I	75 °C (167 °F)

## VCXG.I.PTP

Camera Type	max. Temperature (internal temperature sensor)
<b>Monochrome / Color</b>	
VCXG-32M.I.PTP / VCXG-32C.I.PTP	70 °C (158 °F)
VCXG-51M.I.PTP / VCXG-51C.I.PTP	70 °C (158 °F)
VCXG-124M.I.PTP / VCXG-124C.I.PTP	70 °C (158 °F)

## VCXG.I.XT

Camera Type	max. Temperature (internal temperature sensor)
<b>Monochrome / Color</b>	
VCXG-13M.I.XT / VCXG-13C.I.XT	75 °C (167 °F)
VCXG-15M.I.XT / VCXG-15C.I.XT	75 °C (167 °F)
VCXG-25M.I.XT / VCXG-25C.I.XT	75 °C (167 °F)
VCXG-32M.I.XT / VCXG-32C.I.XT	75 °C (167 °F)
VCXG-51M.I.XT / VCXG-51C.I.XT	75 °C (167 °F)
VCXG-53M.I.XT / VCXG-53C.I.XT	75 °C (167 °F)
VCXG-82M.I.XT / VCXG-82C.I.XT	75 °C (167 °F)
VCXG-124M.I.XT / VCXG-124C.I.XT	75 °C (167 °F)
VCXG-127M.I.XT / VCXG-127C.I.XT	75 °C (167 °F)
VCXG-201M.R.I.XT / VCXG-201C.R.I.XT	75 °C (167 °F)
VCXG-241M.R.I.XT / VCXG-241C.R.I.XT	75 °C (167 °F)

## VCXG.XC

Camera Type	max. Temperature (internal temperature sensor)
<b>Monochrome / Color</b>	
VCXG-14SWIR.XC	75 °C (167 °F)
VCXG-51M.XC	70 °C (158 °F)

## VCXU

Camera Type	max. Temperature (internal temperature sensor)
<b>Monochrome / Color</b>	
VCXU-02M / VCXU-02C	75 °C (167 °F)
VCXU-04M / VCXU-04C	72 °C (161.6 °F)
VCXU-13M / VCXU-13C	75 °C (167 °F)
VCXU-15M / VCXU-15C	72 °C (161.6 °F)
VCXU-23M / VCXU-23C	72 °C (161.6 °F)
VCXU-22M.R / VCXU-22C.R	72 °C (161.6 °F)
VCXU-24M / VCXU-24C	72 °C (161.6 °F)
VCXU-25M / VCXU-25C	75 °C (167 °F)
VCXU-31M / VCXU-31C	72 °C (161.6 °F)
VCXU-32M / VCXU-32C	72 °C (161.6 °F)
VCXU-50M / VCXU-50C	72 °C (161.6 °F)
VCXU-51M / VCXU-51C	72 °C (161.6 °F)
VCXU-50MP	72 °C (161.6 °F)
VCXU-53M / VCXU-53C	75 °C (167 °F)
VCXU-65M.R / VCXU-65C.R	73 °C (163.4 °F)
VCXU-90M / VCXU-90C	72 °C (161.6 °F)
VCXU-91M / VCXU-91C	72 °C (161.6 °F)
VCXU-123M / VCXU-123C	72 °C (161.6 °F)
VCXU-124M / VCXU-124C	72 °C (161.6 °F)
VCXU-125M.R / VCXU-125C.R	75 °C (167 °F)
VCXU-201M.R / VCXU-201C.R	75 °C (167 °F)

### 4.3 Lens mounting

#### Notice

Avoid contamination of the sensor and the lens by dust and airborne particles when mounting the lens to the device!

Therefore the following points are very important:

- Install the camera in an environment that is as dust free as possible!
- Keep the dust cover (bag) on camera as long as possible!
- Hold the camera downwards with unprotected sensor.
- Avoid contact with any optical surface of the camera!

## 4.4 IP Protection classes (VCXG.I / .I.XT)

### Notice

#### Definition IP65 / IP67

IP65 says that the camera housing is dust tight and hose-proof. That means it is protected against water jet that is projected by a nozzle striking the housing from any direction.

IP67 stands for dust tightness besides the protection against submersion into 1 meter deep water for up to 30 minutes. The desired protection level is given as long as the difference in temperature between camera and water is less than 5 K and the water has a temperature of 15 °C (+ 59 °F) ... 35 °C (+ 95 °F).

### Notice

The IP Protection classes for VCXG, VCXU and VCXG.XC was not evaluated by UL.

### ⚠ Caution

In order to achieve the mentioned IP protection level, please note the following information:



The tube needs to be screwed on gap-free as shown in the figure below.

The M12 connectors need to be tightened with a torque value of 0.4 Nm.

For that Baumer suggests the use of a torque driver (such as Wiha TorqueVario®-S ESD) in combination with a wrench for assembling sensor/actuator cables with M12 connector (such as Phoenix Contact SAC BIT M12-D15).

### Sealing rings

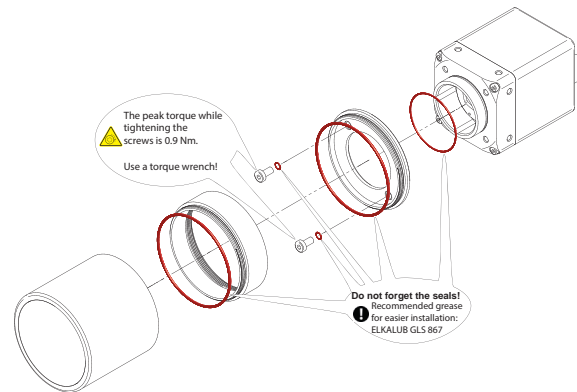

### Gap-free assembly

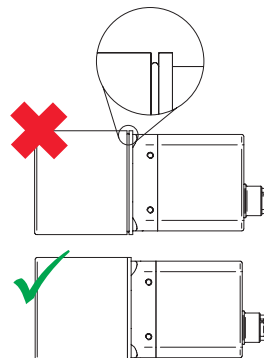



## 4.5 Filter replacement

A filter is installed in color cameras. This filter can lead to limitations in the applicability of the sensor for specific applications.

Proceed as follows to replace the filter.

### Notice

Avoid contamination of the filter, sensor and the lens by dust and airborne particles!

Perform the filter replacement in a dust-free room with clean tools!

### Procedure

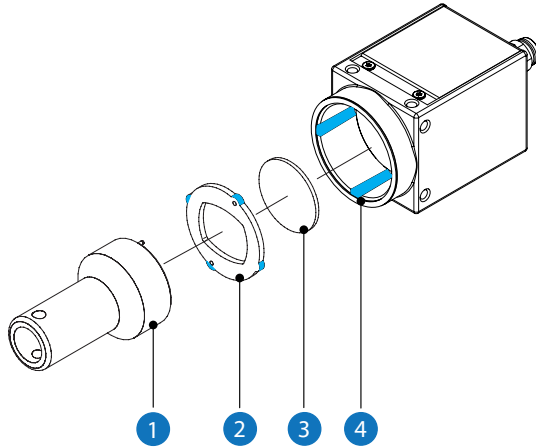

1. Insert the assembly tool (1) into the sensor opening. Place the two pins at the front end into the locator holes of the filter holder (2).
2. Turn the filter holder (2) until the guide tabs can be seen in the guide grooves (4).
3. Remove the filter holder (2).
4. Carefully remove the existing filter (3). Do not touch the sensor!
5. Insert the new filter into the sensor opening.
6. Put the filter holder (2) back in.
7. Turn the filter holder (2) until the guide tabs cannot be seen in the guide grooves (4).

## 4.6 Cable requirements for UL conformity

For UL conform installations the cables used must meet the following requirements:

- shielding for optimum electrical noise immunity
- IP protection class according to intended use
- UL approval
- dielectric strength according to the operating voltages used (min. 30 V)
- temperature stability in the specified device temperature range (min. 70 °C (158 °F))
- minimum cross section of cable suitable for max. output current

## 4.7 Cleaning

Due to its compact design, the device is characterized by almost maintenance-free operation.

When used for the intended purpose, it is possible that the device may need to be cleaned from time to time. Very clean optical surfaces (cover glass) are required for the consistent and reproducible operation of the device.

### Housing

⚠ Caution!	
	<p>Volatile solvents for cleaning. Volatile solvents damage the surface of the camera. Never use volatile solvents (benzine, thinner) for cleaning!</p>

To clean the surface of the camera housing, use a soft, dry cloth. To remove persistent stains, use a soft cloth dampened with a small quantity of neutral detergent, then wipe dry.

### Filter / Cover glass sensor

Notice	
	<p>The sensor is mounted dust-proof. Remove of the cover glass for cleaning is not necessary.</p>

Avoid cleaning the cover glass of the sensor if possible. To prevent dust, follow the instructions under "Install lens".

If you must clean it, use compressed air or a soft, lint free cloth dampened with a small quantity of pure alcohol.

### Tube cover glass

For cleaning, use a soft, lint-free cloth to clean the surface of the tube cover glass with a gentle pressure, without scratching.

To clean stubborn dirt, commonly available window cleaning agent is recommended.

⚠ Caution!	
	<p>Ensure that no residues of the cleaning agent or scratches remain on the glass. These can permanently damage the reproducibility of the results from the device.</p>

⚠ Caution!	
	<p>As so many cleaning agents are available, we hope you understand that we cannot test every single one. Resistance to cleaning agents and areas of use depends upon the specific application. Cleaning agents must be tested on an discreet area of the device under application conditions to evaluate if they are suitable.</p>

## 4.8 Mechanical Tests

Environmental Testing	Standard	Parameter	
Vibration, sinusoidal	IEC 60068-2-6	Frequency Range	10 - 2000 Hz
		Amplitude underneath crossover frequencies	1.5 mm
		Acceleration	10 g
		Test duration / Axis	150 min
Vibration, broad band	IEC 60068-2-64	Frequency range	
		V CXG (.XC / .PTP) / V CXU	20 - 1000 Hz
		V CXG.I (.PTP) / .XT	5 - 2000 Hz
		Acceleration RMS	10 g
		Test duration / Axis	300 min
Shock	IEC 60068-2-27	Puls time	11 ms / 6 ms
		Acceleration	50 g / 100 g
		Number of shocks per direction and axis	10
Bump	IEC60068-2-29	Pulse Time	2 ms
		Acceleration	100 g
		Number of bumps per direction and axis	5000

### Vibrations

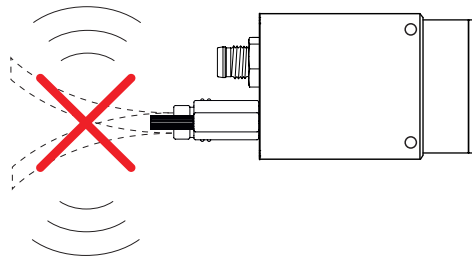

#### Caution!



Vibration that is not decoupled can damage the ports on the camera. Cables have to be fixed in a way that vibrations are not transmitted into the camera.

## 5. Pin-Assignment / LED-Signaling

### Danger!

#### Use in wet environments requiring IP67 protection

Risk of electric shock. Electric shock can be fatal or cause serious injury.



Use is only permitted under consideration of pollution degree 2 and overvoltage category 2.

The M12 connectors must comply with the IEC 61076-2-101 standard.

The dielectric strength and withstand voltage for the plug/socket combination must be checked according to DIN EN 60664-1:2008-01 for 60 V.

### Notice

#### Class 2 per NEC / Protection Class III

The device is intended to be supplied from an isolated Limited Energy Source per UL61010-1, 3rd ed cl. 9.4 or Limited Power Source per UL60950-1 or Class 2 per NEC.

### Notice

The unit is to be connected only to internal Ethernet networks without exiting a facility and being subjected to Telecommunication Network Voltages (TNVs).

## 5.1 VCXG / .PTP / .XC

### 5.1.1 Ethernet Interface

#### Caution!

#### Power supply via PoE and digital IO connection

The camera (except .XC) supports power supply via PoE (Power over Ethernet) IEEE 802.3af Clause 33, 48V.



Parallel power supply via Ethernet interface and digital IO port is subject to deviations and tolerances. These might damage the camera.

Only use a single form of power supply!

#### 8P8C Modular Jack (RJ45) with LEDs

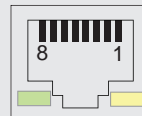

1	MX1+	5	MX3-
2	MX1-	6	MX2-
3	MX2+	7	MX4+
4	MX3+	8	MX4-

**⚠ Caution!**



The camera is equipped with a TYPE090 fixed connector. Using a Free Connector (cable) other than TYPE090 could damage the Fixed Connector.

Only use cables with a TYPE090 Free Connector.

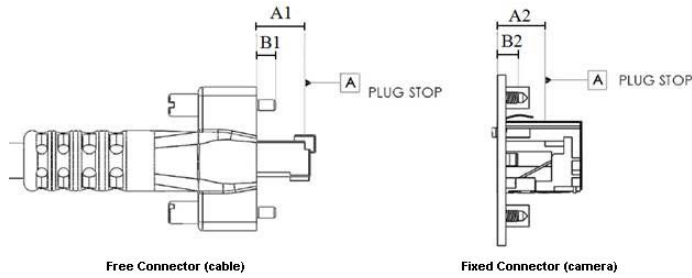

Dimension - Free Connector (cable)	TYPE090	TYPE110 <b>Do not use!</b>
From overmold to plug stop (A1)	9.0 mm (-0.50 + 0.00)	11.0 mm (-0.47 + 0.00)
From overmold to tip of thumbscrews (B1)	4.25 mm (-1.00 + 0.25)	4.25 mm (-1.00 + 0.25)

Dimension – Fixed Connector (camera)	TYPE090
From contact point to plug stop (A2)	9.0 mm (-0.00 + 1.00)
From contact point to bottom of thumb-screw thread (B2)	4.5 mm (-0.00 + 1)

### 5.1.2 Power Supply and IOs

**Power Supply / Digital-IOs (on camera side)**  
wire colors of the connecting cable (ordered separately)

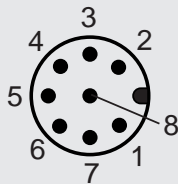

1	GPIO (Line2)	white	5	Power V <sub>CC</sub> OUT1	grey
2	Power V <sub>CC</sub>	brown	6	OUT1 (Line3)	pink
3	IN1 (Line0)	green	7	GND (Power, GPIO)	blue
4	GND IN1	yellow	8	GPIO (Line1)	red

#### Power Supply

Power V <sub>CC</sub>	12 V ... 24 V (± 20 %) (Power consumption: max. 3.7 W)
-----------------------	--

### 5.1.3 GPIO (General Purpose Input/Output)

Lines 1 and 2 are GPIOs and can be inputs and outputs.

Used as an input: (0 ... 0.8 V low, 2.0 ... 3.0 V high).

Used as an output: (0 ... 0.4 V low, 2.4 ... 3.3 V high),  
@ 1 mA load (high) / 50 mA sink (low)

#### ⚠ Caution

The General Purpose IOs (GPIOs) are not potential-free and do not have an overrun cut-off. Incorrect wiring (overvoltage, undervoltage or voltage reversal) can lead to defects within the electronics system.



GPIO Power  $V_{CC}$ : 3.3 V DC  
Load resistor for TTL-High-Level: approx. 2.7 k $\Omega$

The GPIOs are configured as an input through the default camera settings. They must be connected to GPIO\_GND if not used or not configured as an output. The configuration as output by default (stored in a user set) is possible with cameras  $\geq$  Release 3.

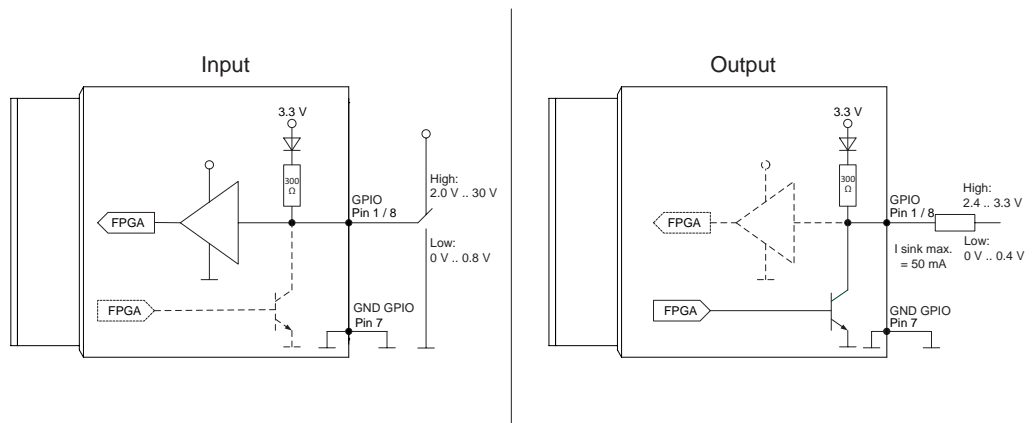

### 5.1.4 Digital-IO

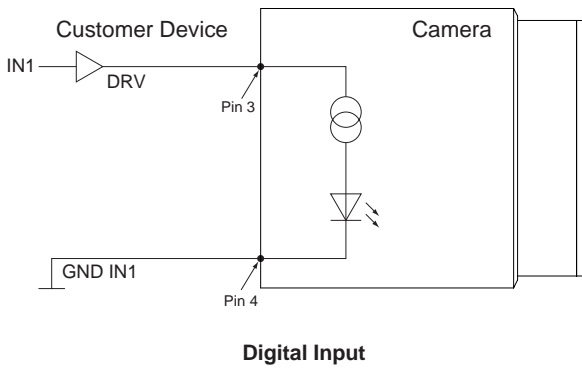
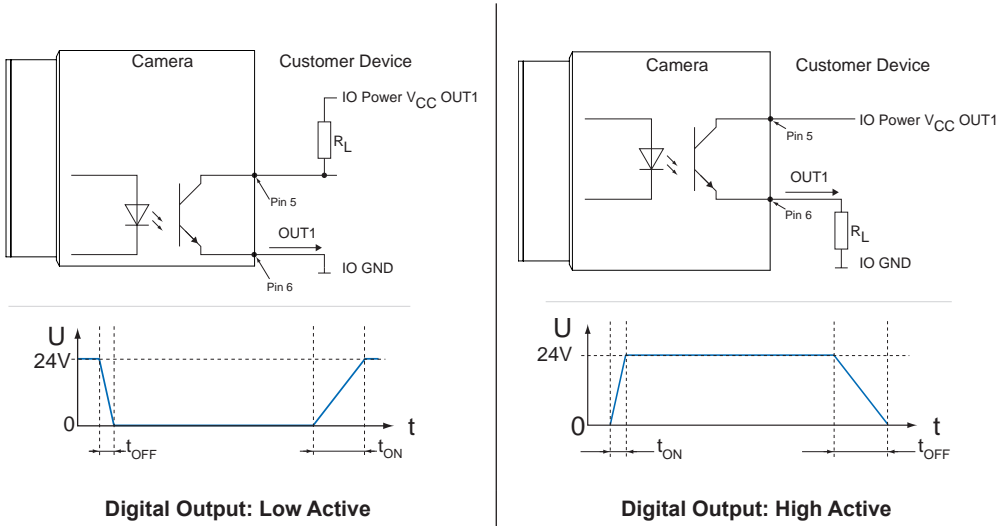

### 5.1.5 LED Signaling

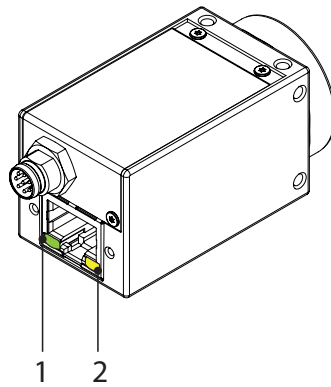

LED positions on Bau-mer VCXG cameras.

LED	Signal	Meaning
1	green static	link active
	green flash	receiving
2	yellow static	error
	yellow flash	transmitting

## 5.2 VCXG.I / .XT / .PTP

### 5.2.1 Ethernet Interface

**⚠ Caution!**

**Power supply via PoE and digital IO connection**  
 The camera supports power supply via PoE (Power over Ethernet) IEEE 802.3af Clause 33, 48V.

 Parallel power supply via Ethernet interface and digital IO port is subject to deviations and tolerances. These might damage the camera.

Only use a single form of power supply!

**⚠ Caution!**

In order to achieve the mentioned IP protection level, the M12 connectors need to be tightened with a torque value of 0.4 Nm.

 For that Baumer suggests the use of a torque driver (such as Wiha TorqueVario®-S ESD) in combination with a wrench for assembling sensor/actuator cables with M12 connector (such as Phoenix Contact SAC BIT M12-D15).

**Ethernet**  
(SACC-CI-M12FS-8CON-L180-10G)

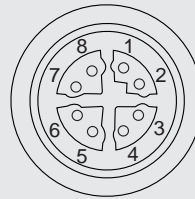

1	MX1+	5	MX4+
2	MX1-	6	MX4-
3	MX2+	7	MX3-
4	MX2-	8	MX3+

### 5.2.2 Power Supply and IOs

**Power Supply / Digital-IOs (on camera side)**  
(SACC-CI-M12MS-12CON-L180)  
**wire colors of the connecting cable (ordered separately)**



1	Power V <sub>CC</sub>	brown	7	OUT3 (Line6)	black
2	GND (Power)	blue	8	IN3 (Line2)	grey
3	IN1 (Line0)	white	9	OUT4 (Line7)	red
4	OUT1 (Line4)	green	10	IN4 (Line3)	violet
5	IN2 (Line1)	pink	11	GND (IO)	grey-pink
6	OUT2 (Line5)	yellow	12	Power (IO)	red-blue



## Power Supply

Power $V_{CC}$	12 V ... 24 V ( $\pm 20\%$ ) (Power consumption: max. 3.7 W)
Power (IO)	For UL conform installations: 12 V (- 20 %) ... 24 V (+ 20 %) For not UL conform installations: 12 V (- 20 %) ... 48 V (+ 10 %)

### 5.2.3 Digital-IO

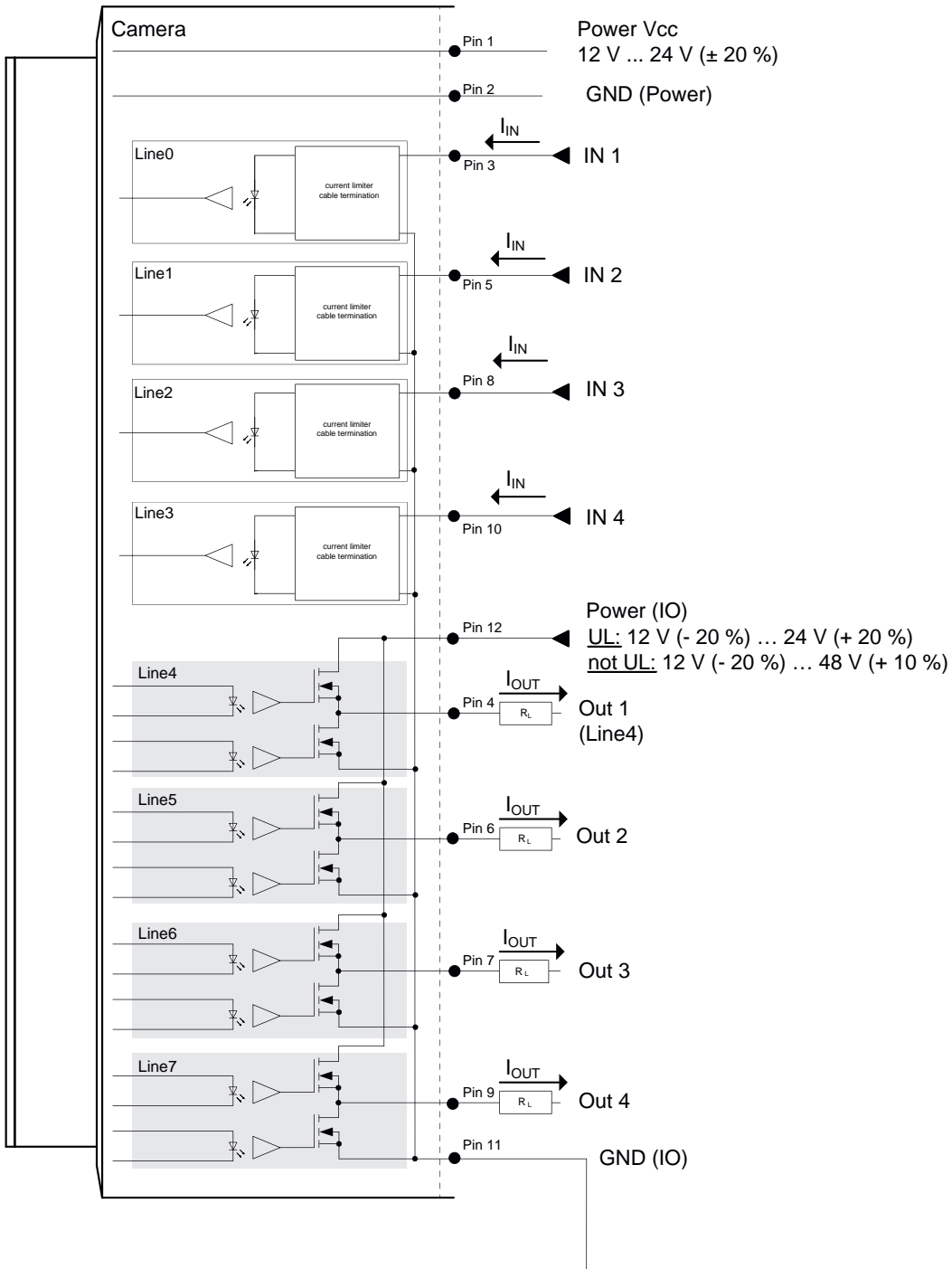

## 5.2.4 LED Signaling

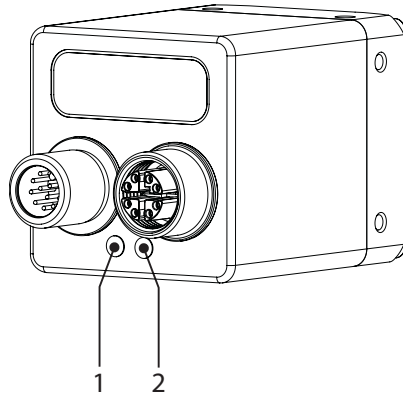

LED positions on Baumer VCXG.I / .XT cameras.

LED	Signal	Meaning
1	yellow static	error
	yellow flash	transmitting
2	green static	link active
	green flash	receiving

## 5.3 VCXU

### 5.3.1 USB 3.0 Interface

#### USB 3.0 Micro B



1	VBUS	6	MicB_SSTX-
2	D-	7	MicB_SSTX+
3	D+	8	GND_DRAIN
4	ID	9	MicB_SSRX-
5	GND	10	MicB_SSRX+

#### ⚠ Caution

If the camera is connected to an USB2.0 port image transmission is disabled by default. The camera consumes more than 2.5W which is the maximum allowed by the USB2.0 specification. But there is a possibility to activate the image transmission at your own risk!

This activation could damage your computer's hardware!

#### Procedure



1. Open the camera in the *Camera Explorer*.
  2. Select the Profile *GenICam Guru*.
  3. Activate the Feature *USB2 Support Enable* in the category *Device Control*.
  4. Disconnect the data connection of the camera to the USB 2.0 port.
  5. Connect the data connection of the camera to the USB 2.0 port.
- Images will be transmitted via the USB 2.0 port.

### 5.3.2 Digital-I/Os

#### Power Supply / Digital-I/Os (on camera side) wire colors of the connecting cable (ordered separately)

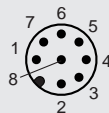

1	GPIO (Line2)	white	5	Power VCC OUT1	grey
2	not connected	brown	6	OUT1 (Line3)	pink
3	IN1 (Line0)	green	7	GND GPIO	blue
4	GND IN1	yellow	8	GPIO (Line1)	red

#### Power Supply

Power V <sub>CC</sub>	5 V via USB, (Power consumption: max. 3.9 W)
-----------------------	--

### 5.3.3 GPIO (General Purpose Input/Output)

Lines 1 and 2 are GPIOs and can be inputs and outputs.

Used as an input: (0 ... 0.8 V low, 2.0 ... 3.0 V high).

Used as an output: (0 ... 0.4 V low, 2.4 ... 3.3 V high),  
@ 1 mA load (high) / 50 mA sink (low)

#### ⚠ Caution

The General Purpose IOs (GPIOs) are not potential-free and do not have an overrun cut-off. Incorrect wiring (overvoltage, undervoltage or voltage reversal) can lead to defects within the electronics system.



GPIO Power  $V_{CC}$ : 3.3 V DC  
Load resistor for TTL-High-Level: approx. 2.7 k $\Omega$

The GPIOs are configured as an input through the default camera settings. They must be connected to GPIO\_GND if not used or not configured as an output. The configuration as output by default (stored in a user set) is possible with cameras  $\geq$  Release 3.

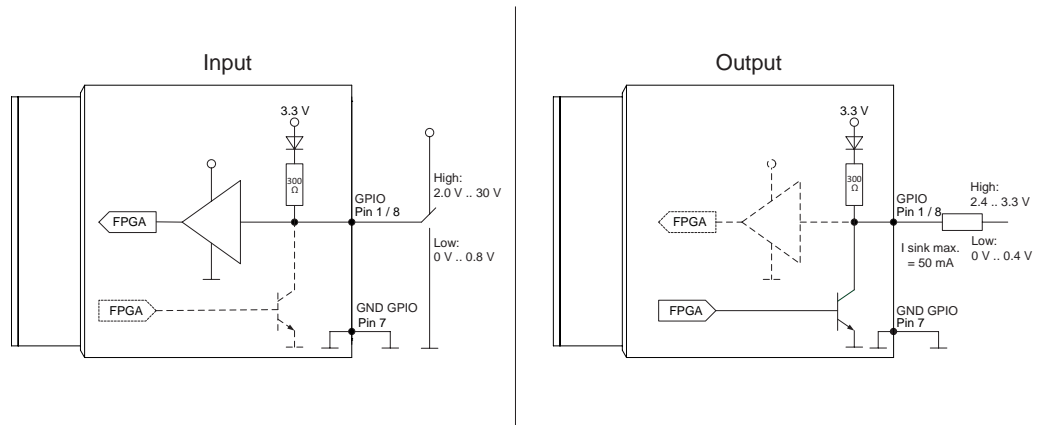

### 5.3.4 Digital-IO

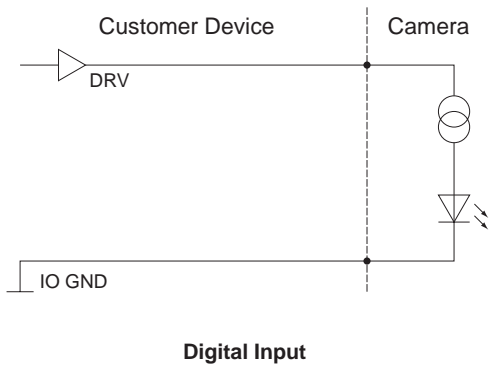
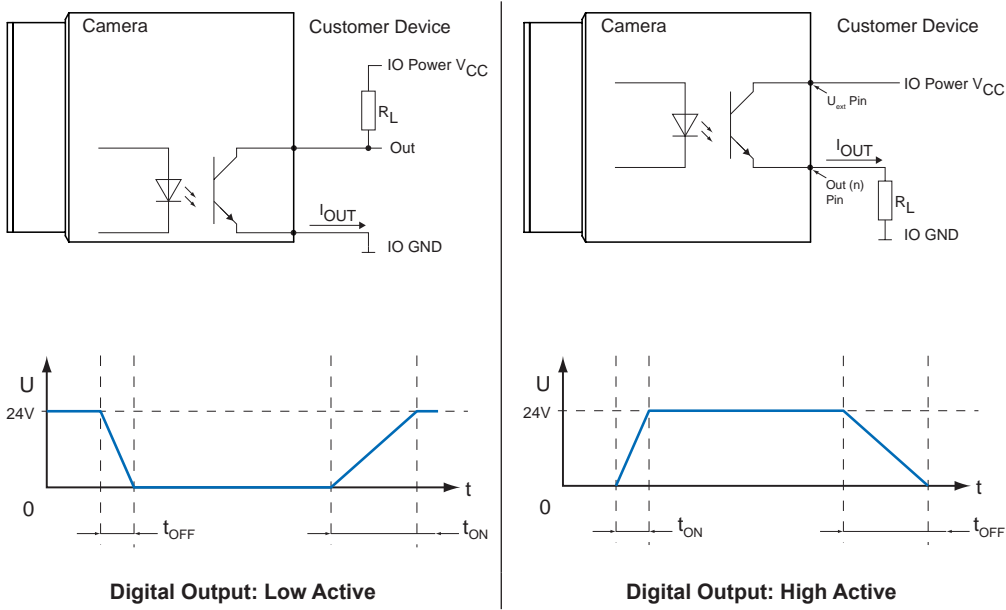

### 5.3.5 LED Signaling

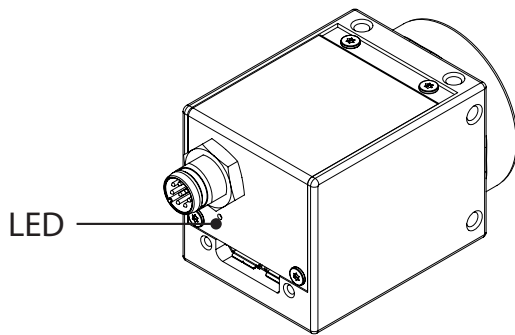

LED position on Bau-mer VCXU camera.

	Signal	Meaning
LED	green flash	Power on
	green	USB 3.0 connection
	red	USB 2.0 connection
	yellow	Readout active
	red flash	Update

## 6. Product Specifications

### 6.1 Spectral Sensitivity

The spectral sensitivity characteristics of monochrome and color matrix sensors for cameras of this series are displayed in the following graphs. The characteristic curves for the sensors do not take the characteristics of lenses and light sources without filters into consideration.

Values relating to the respective technical data sheets.

#### Filter glasses / Cover glasses

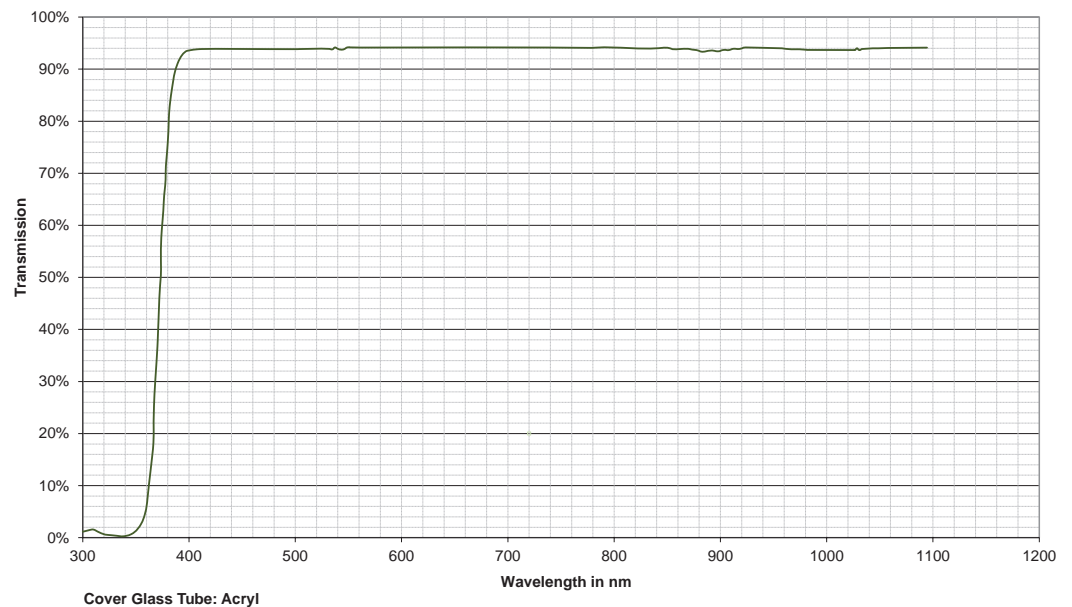
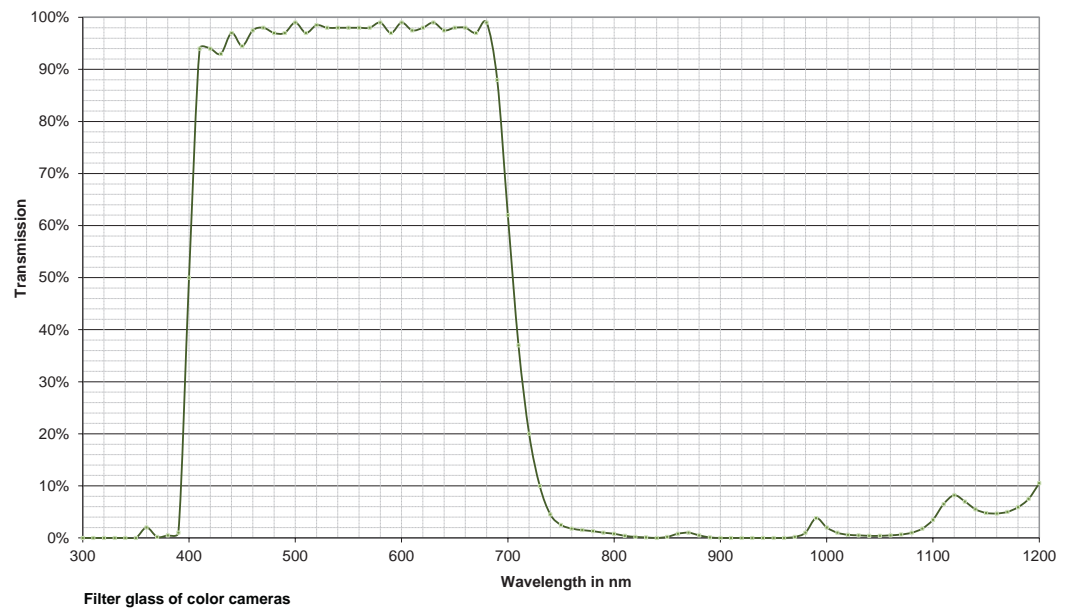

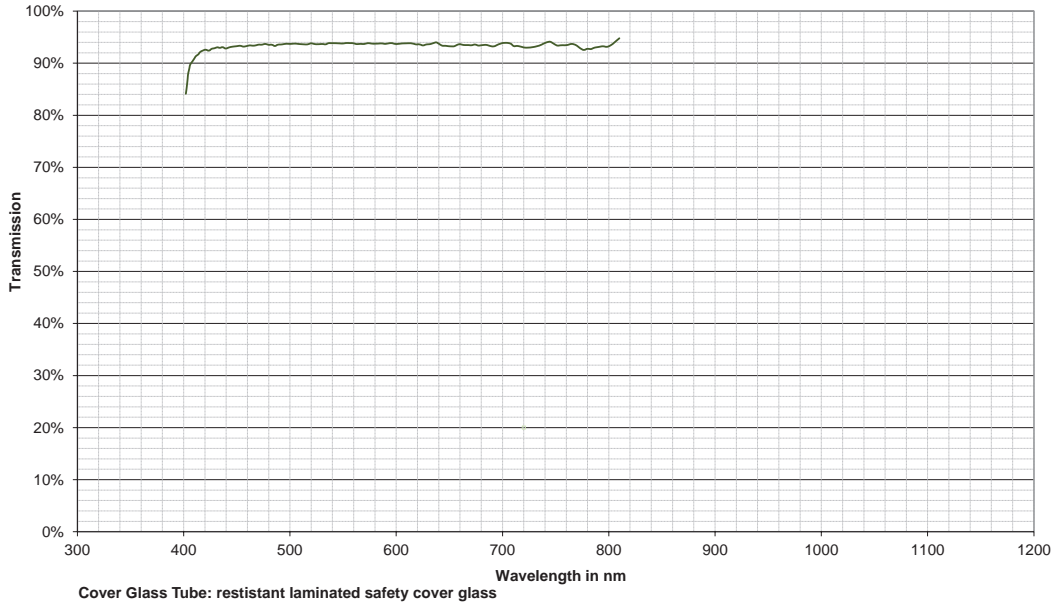

## Cameras

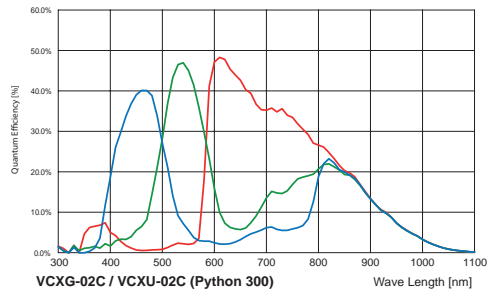
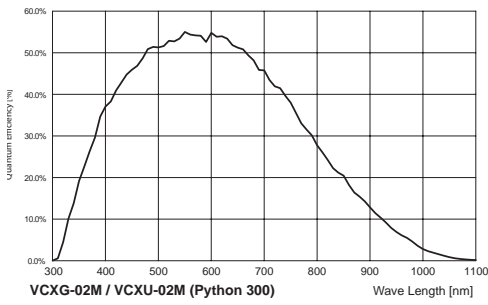

Spectral sensitivities for Baumer cameras with 0.3 MP sensor.

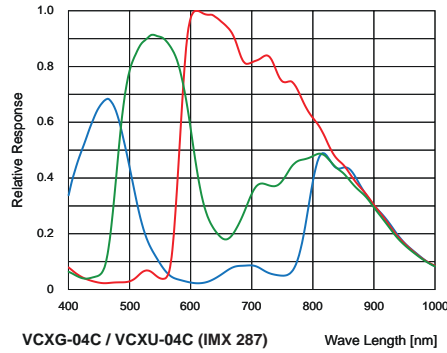
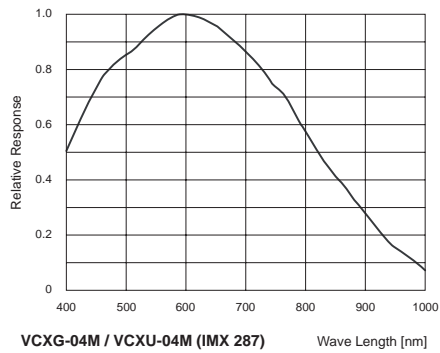

Spectral sensitivities for Baumer cameras with 0.4 MP sensor.

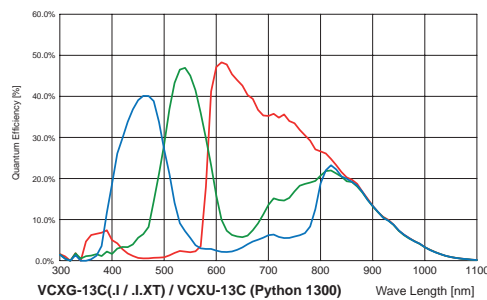
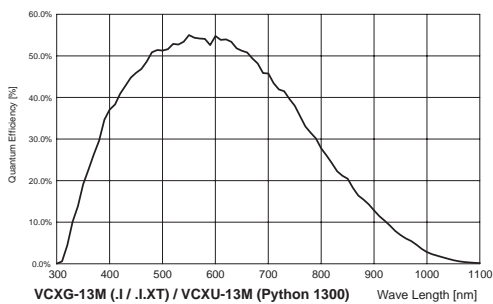

Spectral sensitivities for Baumer cameras with 1.3 MP sensor.

Spectral sensitivities for Baumer cameras with 1.3 MP sensor.

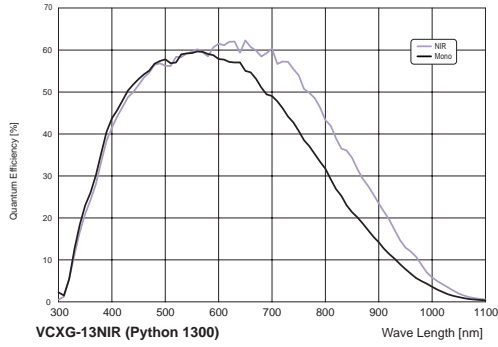

Spectral sensitivities for Baumer cameras with 1.3 MP SWIR sensor.

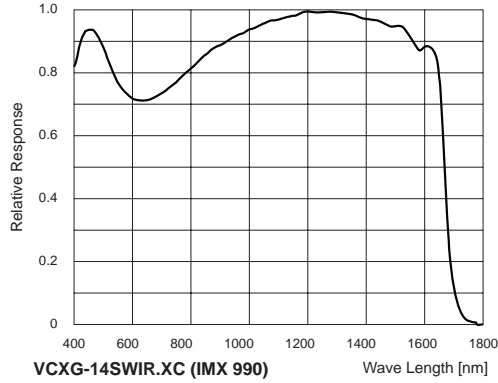

Spectral sensitivities for Baumer cameras with 1.5 MP sensor.

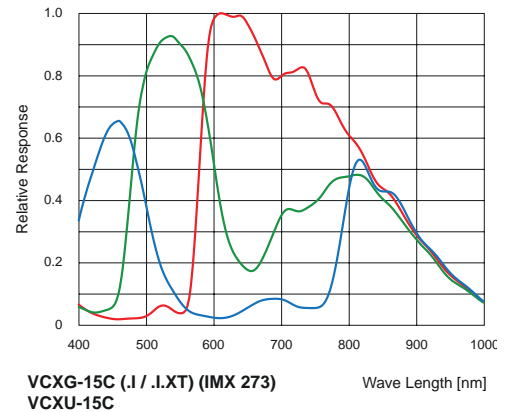
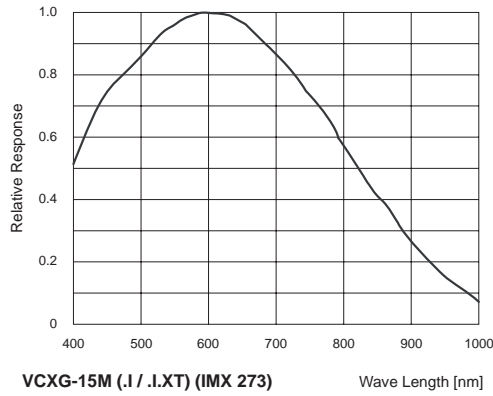

Spectral sensitivities for Baumer cameras with 2.1 MP sensor.

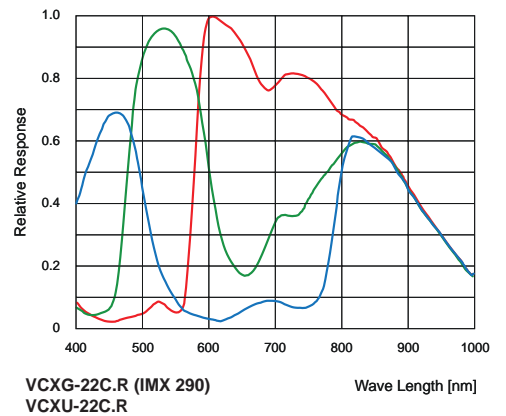
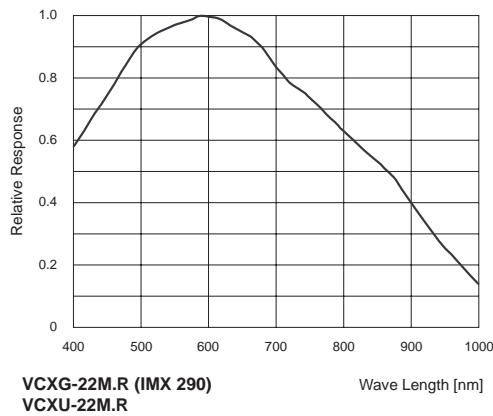



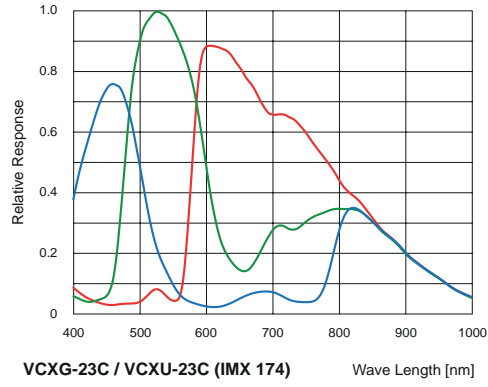
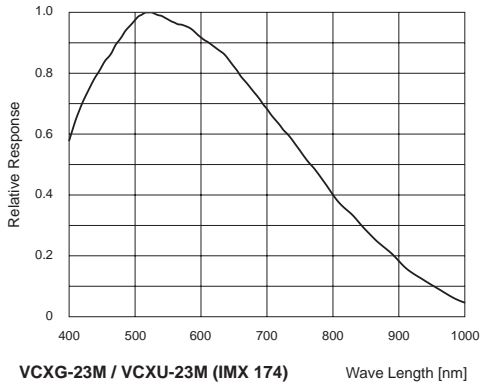

Spectral sensitivities for Baumer cameras with 2.3 MP sensor.

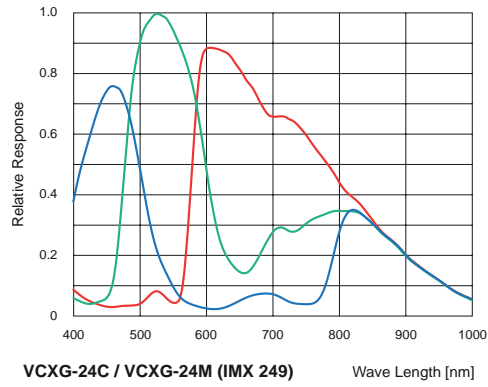
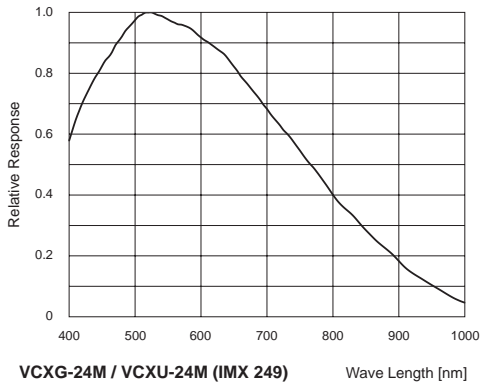

Spectral sensitivities for Baumer cameras with 2.3 MP sensor.

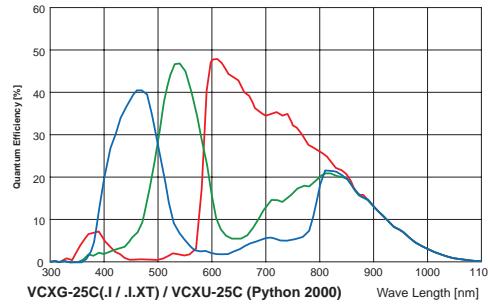
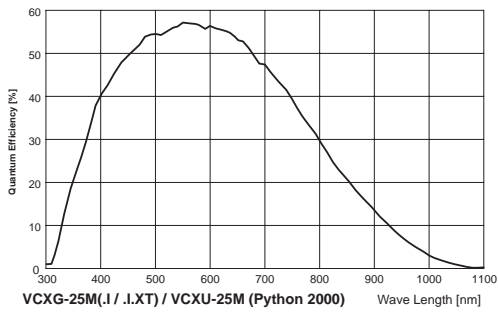

Spectral sensitivities for Baumer cameras with 2.3 MP sensor.

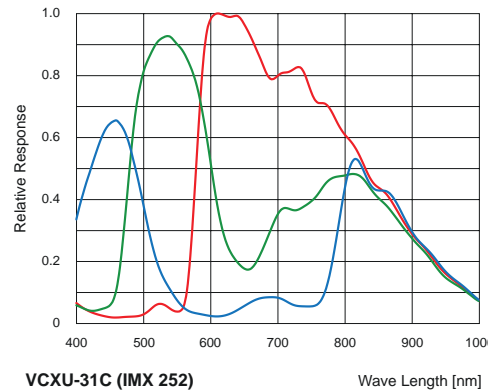
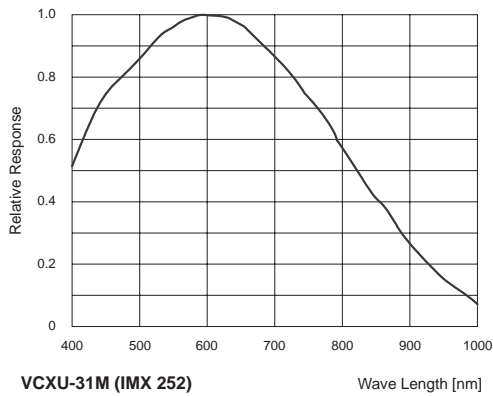

Spectral sensitivities for Baumer cameras with 3.1 MP sensor.

Spectral sensitivities for Baumer cameras with 3.1 MP sensor.

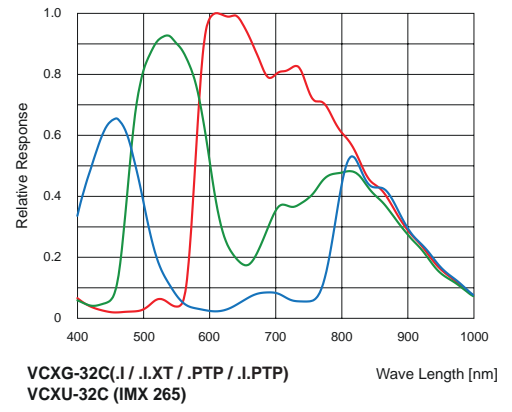
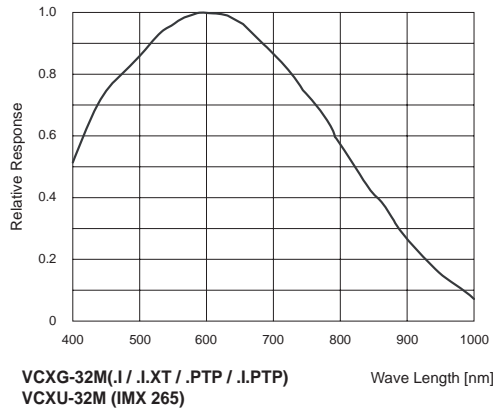

Spectral sensitivities for Baumer monochrome polarized Matrix, cameras with 5.0 MP sensor.

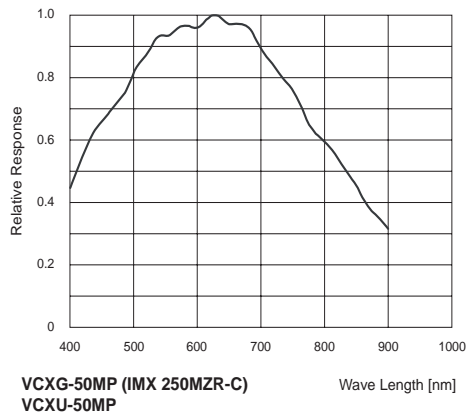

Spectral sensitivities for Baumer cameras with 5.0 MP sensor.

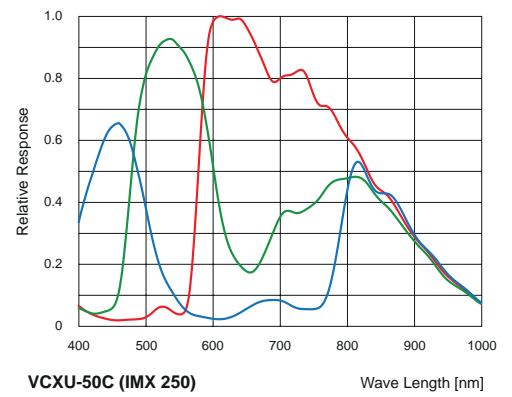
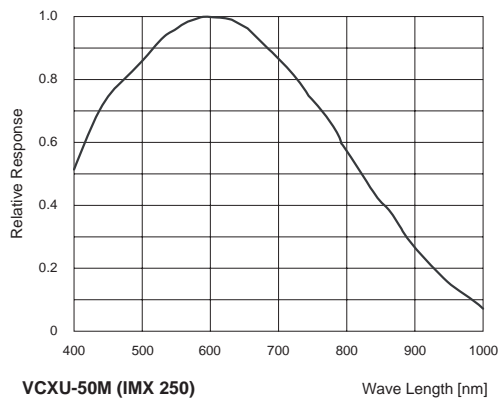

Spectral sensitivities for Baumer cameras with 5.0 MP sensor.

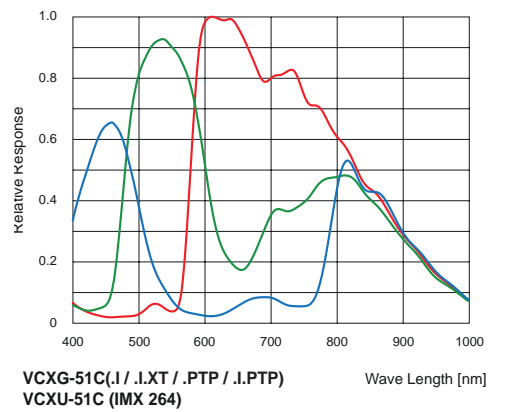
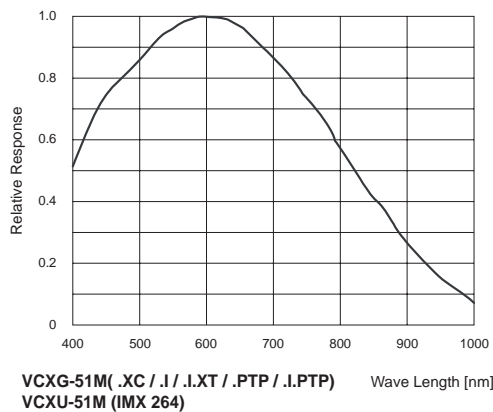

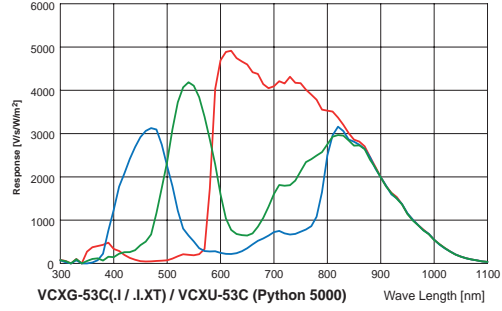
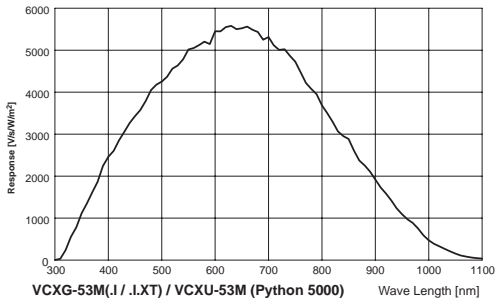

Spectral sensitivities for Baumer cameras with 5.3 MP sensor.

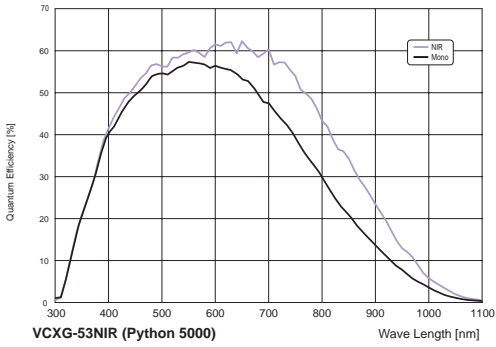

Spectral sensitivities for Baumer cameras with 5.3 MP sensor.

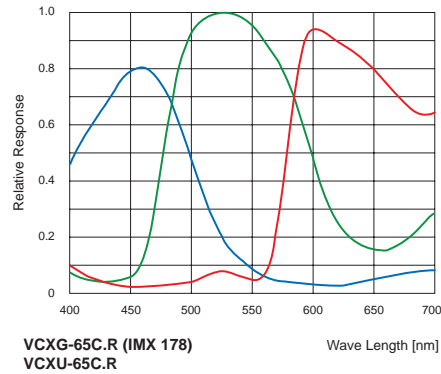
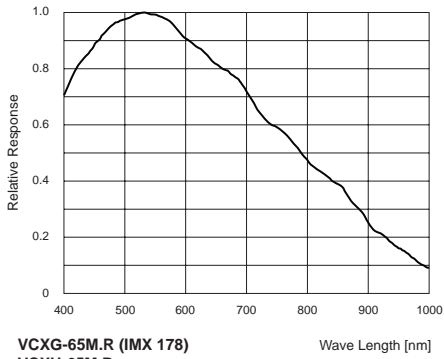

Spectral sensitivities for Baumer cameras with 6.2 MP sensor.

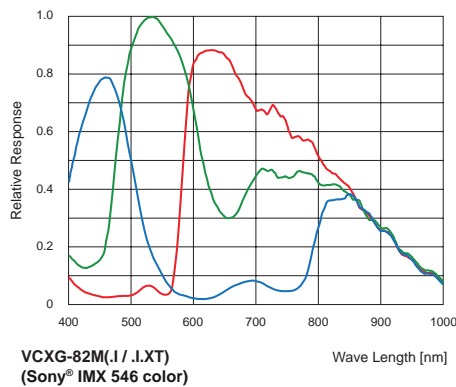
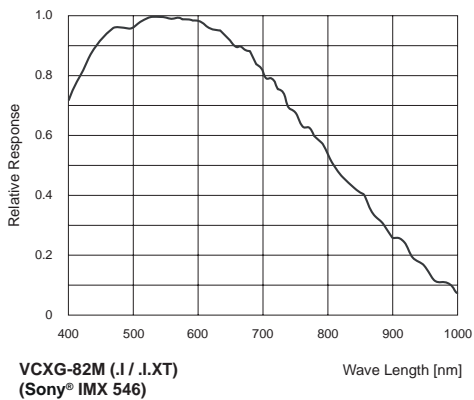

Spectral sensitivities for Baumer cameras with 8 MP sensor.

Spectral sensitivities for Baumer cameras with 9.0 MP sensor.

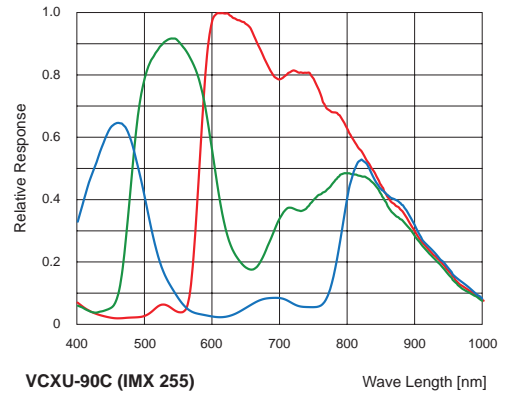
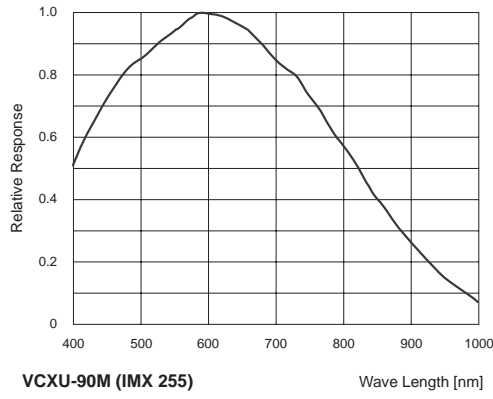

Spectral sensitivities for Baumer cameras with 9.0 MP sensor.

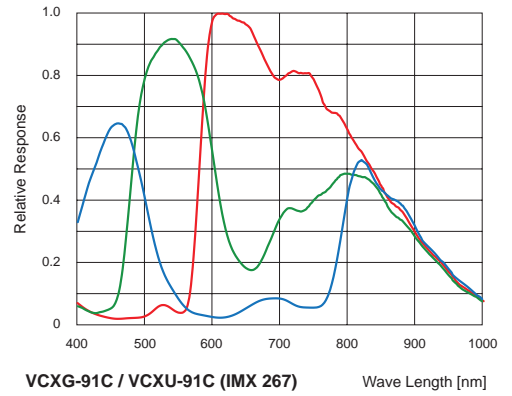
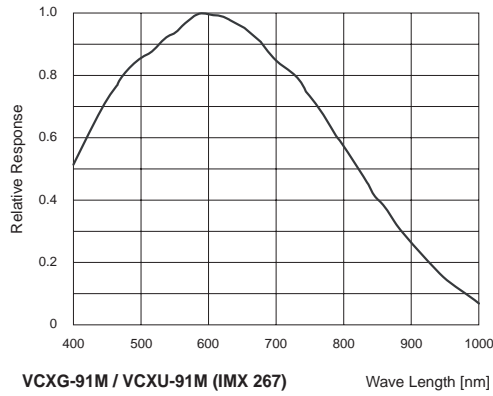

Spectral sensitivities for Baumer cameras with 12.3 MP sensor.

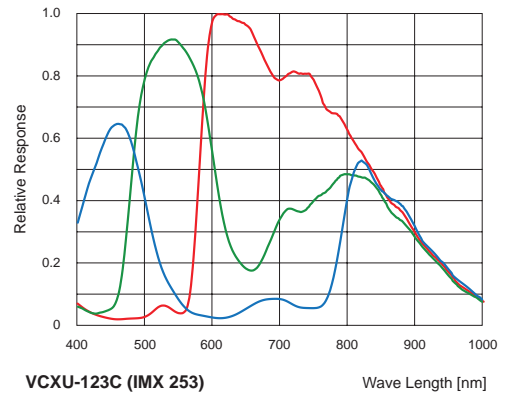
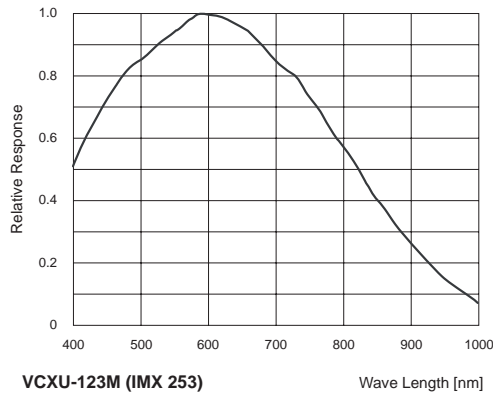

Spectral sensitivities for Baumer cameras with 12.3 MP sensor.

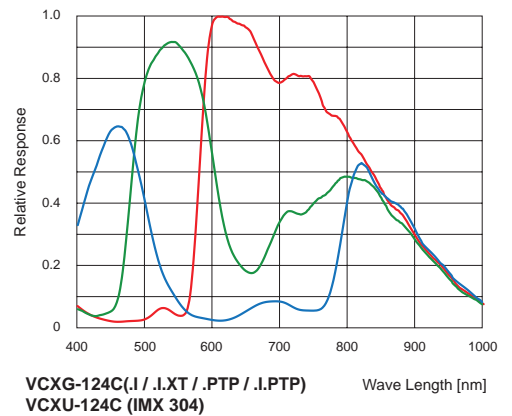
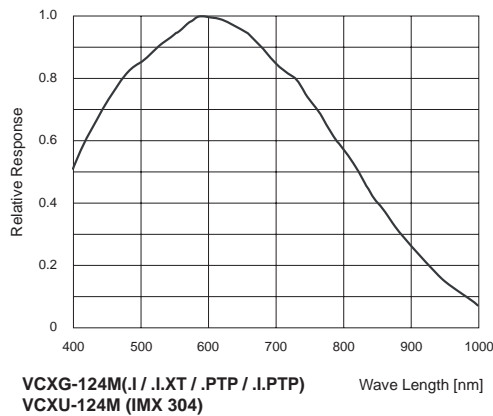

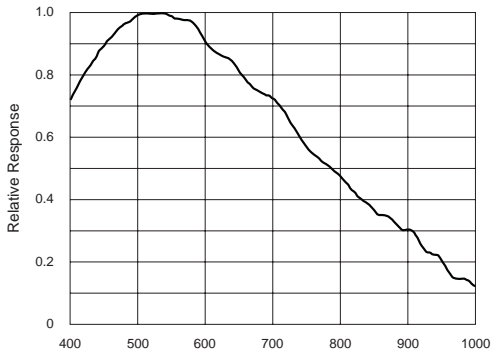

**VCXG-125M.R (IMX 226)**  
**VCXU-125M.R**

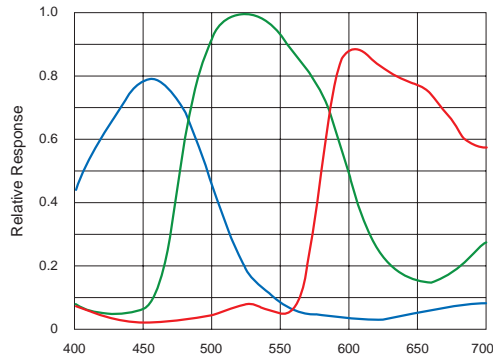

**VCXG-125C.R (IMX 226)**  
**VCXU-125C.R**

Spectral sensitivities for Baumer cameras with 12.3 MP sensor.

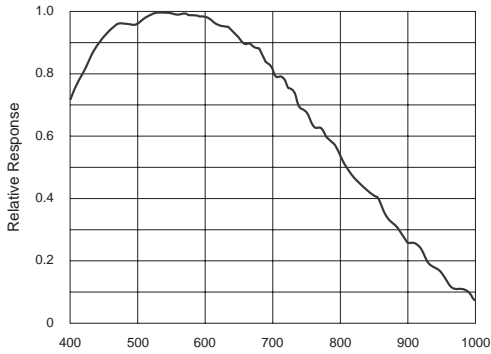

**VCXG-127M.(I / .I.XT)**  
**(Sony® IMX 545)**

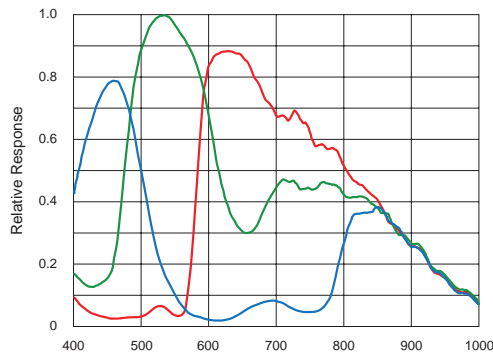

**VCXG-127C.(I / .I.XT)**  
**(Sony® IMX 545)**

Spectral sensitivities for Baumer cameras with 12.2 MP sensor.

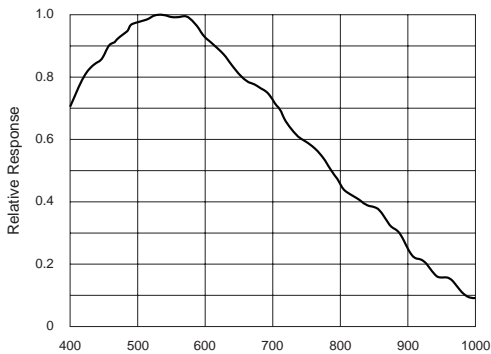

**VCXG-201M.R (.I / .I.XT) (IMX 183)**  
**VCXU-201M.R**

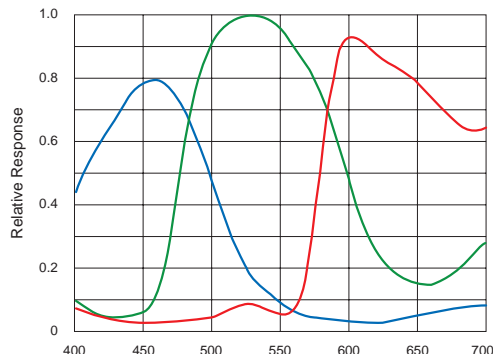

**VCXG-201C.R (.I / .I.XT) (IMX 183)**  
**VCXU-201C.R**

Spectral sensitivities for Baumer cameras with 20 MP sensor.

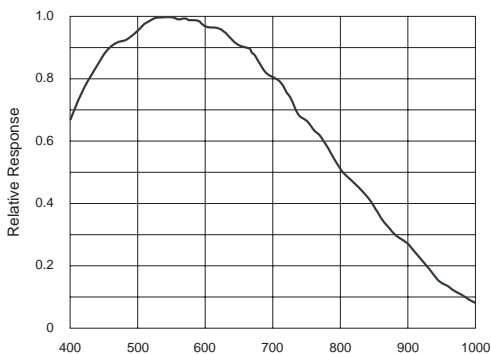

**VCXG-204M (Sony® IMX 541)**

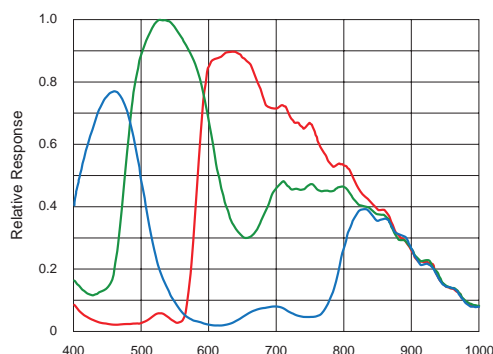

**VCXG-204C (Sony® IMX 541)**

Spectral sensitivities for Baumer cameras with 20.1 MP sensor.

Spectral sensitivities for  
Baumer cameras with  
24 MP sensor.

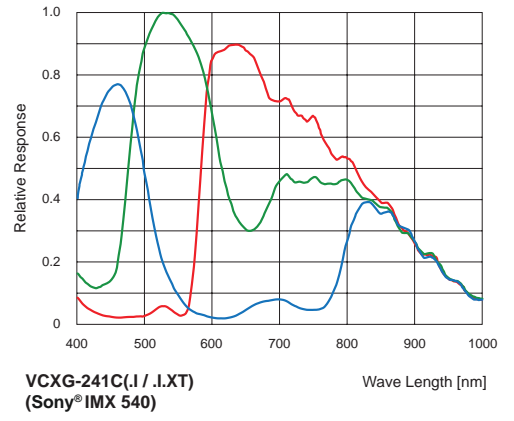
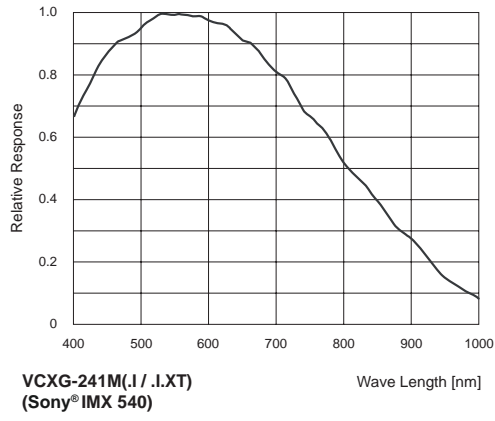

## 6.2 Sensor position accuracy

The typical accuracy by assumption of the root mean square value is displayed in the figures and the tables below:

### 6.2.1 VCXG / .XC / .PTP

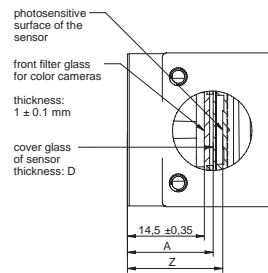
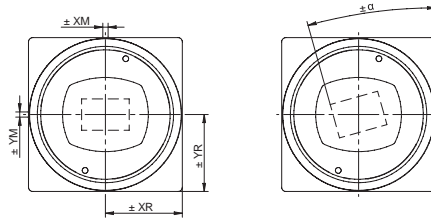

Camera Type	$\pm X_M$ [mm]	$\pm Y_M$ [mm]	$\pm X_R$ [mm]	$\pm Y_R$ [mm]	$Z^{***}_{typ}$ [mm]	$\pm \alpha_{typ}$ [°]	$A^{***}$ [mm]	$D^{**}$ [mm]
VCXG-02*	0.05	0.05	0.05	0.05	17.55 ± 0.100	0.6	16.6	0.55
VCXG-04*	0.07	0.07	0.07	0.07	17.63 ± 0.070	0.6	16.4	0.70
VCXG-13*	0.05	0.05	0.05	0.05	17.55 ± 0.100	0.6	16.6	0.55
VCXG-14*	0.06	0.06	0.06	0.06	17.63 ± 0.070	0.6	15.8	0.50
VCXG-15*	0.07	0.07	0.07	0.07	17.63 ± 0.070	0.6	16.4	0.70
VCXG-22*	0.06	0.06	0.06	0.06	17.58 ± 0.070	0.6	16.6	0.50
VCXG-23*	0.06	0.06	0.06	0.06	17.63 ± 0.070	0.4	15.8	0.50
VCXG-24*	0.06	0.06	0.06	0.06	17.63 ± 0.070	0.4	15.8	0.50
VCXG-25*	0.05	0.05	0.05	0.05	17.65 ± 0.070	0.6	16.5	0.55
VCXG-32*	0.17	0.17	0.17	0.17	17.63 ± 0.070	0.6	16.5	0.70
VCXG-50*	0.17	0.17	0.17	0.17	17.63 ± 0.070	0.6	16.5	0.70
VCXG-51*	0.17	0.17	0.17	0.17	17.63 ± 0.070	0.6	16.5	0.70
VCXG-53*	0.05	0.05	0.05	0.05	17.65 ± 0.070	0.6	16.5	0.55
VCXG-65*	0.06	0.06	0.06	0.06	17.63 ± 0.070	0.4	16.4	0.50
VCXG-82*	0.06	0.06	0.06	0.06	17.63 ± 0.070	0.4	15.8	0.50
VCXG-91*	0.17	0.17	0.17	0.17	17.63 ± 0.070	0.6	16.5	0.70
VCXG-124*	0.17	0.17	0.17	0.17	17.63 ± 0.070	0.6	16.5	0.70
VCXG-125*	0.06	0.06	0.06	0.06	17.63 ± 0.070	0.4	16.5	0.50
VCXG-127*	0.06	0.06	0.06	0.06	17.63 ± 0.070	0.4	15.8	0.50
VCXG-201*	0.06	0.06	0.06	0.06	17.63 ± 0.070	0.6	15.8	0.50
VCXG-204*	0.06	0.06	0.06	0.06	17.63 ± 0.070	0.4	15.8	0.50
VCXG-241*	0.06	0.06	0.06	0.06	17.63 ± 0.070	0.6	15.8	0.50

typical accuracy by assumption of the root mean square value  
\* C or M

\*\* Dimension D in this table is from manufacturer datasheet

\*\*\* For color add 0.35 mm to nominal value

## 6.2.2 VCXG.I / .I.XT / .I.PTP

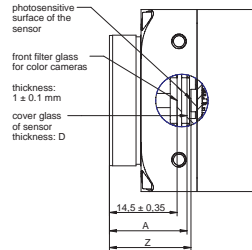
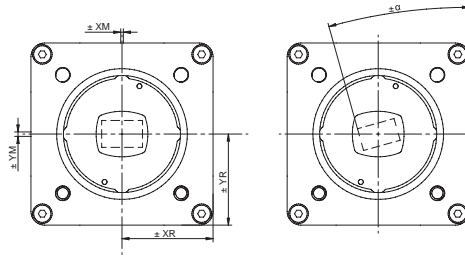

typical accuracy by  
assumption of the root  
mean square value

\* C or M

\*\* Dimension D in this  
table is from manufac-  
turer datasheet

\*\*\* For color add 0.35  
mm to nominal value

Camera Type	$\pm X_M$ [mm]	$\pm Y_M$ [mm]	$\pm X_R$ [mm]	$\pm Y_R$ [mm]	$Z^{***}_{typ}$ [mm]	$\pm \alpha_{typ}$ [°]	$A^{***}$ [mm]	$D^{**}$ [mm]
VCXG.I-13*	0.05	0.05	0.05	0.05	$17.55 \pm 0.100$	0.6	16.6	0.55
VCXG.I-15*	0.07	0.07	0.07	0.07	$17.63 \pm 0.070$	0.6	16.4	0.70
VCXG.I-25*	0.05	0.05	0.05	0.05	$17.65 \pm 0.070$	0.6	16.5	0.55
VCXG.I-32*	0.17	0.17	0.17	0.17	$17.63 \pm 0.070$	0.6	16.5	0.70
VCXG.I-51*	0.17	0.17	0.17	0.17	$17.63 \pm 0.070$	0.6	16.5	0.70
VCXG.I-53*	0.05	0.05	0.05	0.05	$17.65 \pm 0.070$	0.6	16.5	0.55
VCXG.I-82*	0.06	0.06	0.06	0.06	$17.63 \pm 0.070$	0.4	15.8	0.50
VCXG.I-124*	0.17	0.17	0.17	0.17	$17.63 \pm 0.070$	0.6	16.5	0.70
VCXG.I-127*	0.06	0.06	0.06	0.06	$17.63 \pm 0.070$	0.4	15.8	0.50
VCXG.I-201*	0.06	0.06	0.06	0.06	$17.63 \pm 0.070$	0.6	15.8	0.50
VCXG.I-241*	0.06	0.06	0.06	0.06	$17.63 \pm 0.070$	0.4	15.8	0.50



### 6.2.3 VCXU

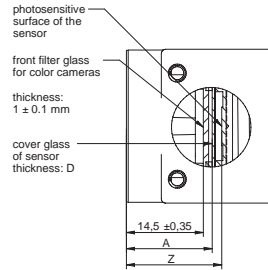
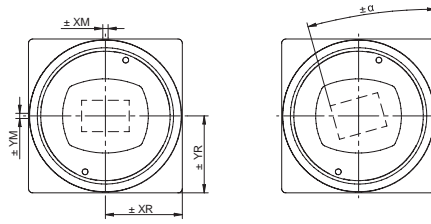

Camera Type	$\pm X_M$ [mm]	$\pm y_M$ [mm]	$\pm X_R$ [mm]	$\pm Y_R$ [mm]	$Z^{***}_{typ}$ [mm]	$\pm \alpha_{typ}$ [°]	$A^{***}$ [mm]	$D^{**}$ [mm]
VCXU-02*	0.05	0.05	0.05	0.05	17.55 ± 0.100	0.6	16.6	0.55
VCXU-04*	0.07	0.07	0.07	0.07	17.63 ± 0.070	0.6	16.4	0.70
VCXU-13*	0.05	0.05	0.05	0.05	17.55 ± 0.100	0.6	16.6	0.55
VCXU-15*	0.07	0.07	0.07	0.07	17.63 ± 0.070	0.6	16.4	0.70
VCXU-22*	0.06	0.06	0.06	0.06	17.58 ± 0.070	0.6	16.6	0.50
VCXU-23*	0.06	0.06	0.06	0.06	17.63 ± 0.070	0.4	15.8	0.50
VCXU-24*	0.06	0.06	0.06	0.06	17.63 ± 0.070	0.4	15.8	0.50
VCXU-25*	0.05	0.05	0.05	0.05	17.65 ± 0.070	0.6	16.5	0.55
VCXU-31*	0.17	0.17	0.17	0.17	17.63 ± 0.070	0.6	16.5	0.70
VCXU-32*	0.17	0.17	0.17	0.17	17.63 ± 0.070	0.6	16.5	0.70
VCXU-50*	0.17	0.17	0.17	0.17	17.63 ± 0.070	0.6	16.5	0.70
VCXU-51*	0.17	0.17	0.17	0.17	17.63 ± 0.070	0.6	16.5	0.70
VCXU-53*	0.05	0.05	0.05	0.05	17.65 ± 0.070	0.6	16.5	0.55
VCXU-65*	0.06	0.06	0.06	0.06	17.63 ± 0.070	0.4	16.4	0.50
VCXU-90*	0.17	0.17	0.17	0.17	17.63 ± 0.070	0.6	16.5	0.70
VCXU-91*	0.17	0.17	0.17	0.17	17.63 ± 0.070	0.6	16.5	0.70
VCXU-123*	0.17	0.17	0.17	0.17	17.63 ± 0.070	0.6	16.5	0.70
VCXU-124*	0.17	0.17	0.17	0.17	17.63 ± 0.070	0.6	16.5	0.70
VCXU-125*	0.06	0.06	0.06	0.06	17.63 ± 0.070	0.4	16.5	0.50
VCXU-201*	0.06	0.06	0.06	0.06	17.63 ± 0.070	0.6	15.8	0.50

typical accuracy by assumption of the root mean square value

\* C or M

\*\* Dimension D in this table is from manufacturer datasheet

\*\*\* For color add 0.35 mm to nominal value

## 6.3 Software

### 6.3.1 Baumer GAPI

Baumer GAPI stands for **B**aumer "**G**eneric **A**pplication **P**rogramming **I**nterface". With this API Baumer provides an interface for quick and easy integration of Baumer industrial cameras using C++, C, and C# (Windows only). This software interface allows changing to other camera models.

This API supports Windows, Linux and ARM-based platforms.

More information can be found at: [www.baumer.com/vision/software](http://www.baumer.com/vision/software)

### 6.3.2 NeoAPI

The NeoAPI is a powerful, user-friendly API for camera integration. It allows quick integration of Baumer cameras in C++, C#, and Python with only a few lines of code.

This API supports Windows, Linux and ARM-based platforms.

More information can be found at: [www.baumer.com/neoAPI](http://www.baumer.com/neoAPI)

### 6.3.3 3<sup>rd</sup> Party Software

Strict compliance with the GenICam™ standard allows Baumer to offer the use of 3<sup>rd</sup> Party Software for operation with cameras of this series.

You can find a current listing of 3<sup>rd</sup> Party Software, which was tested successfully in combination with Baumer cameras, at: <https://www.baumer.com/c/14180>

## 7. Camera Functions

The camera features are represented by a GenICam™ compliant XML description file. The following chapter describes all available features included there. Most of the camera's features are standardized in the GenICam™ SFNC and must use the name defined there. Specialized features not mapping to an existing GenICam™ SFNC name are included as vendor-specific within the 'Custom' namespace.

The camera features are functional grouped by Category features. This elements can be used by software to display the features in more organized way.

### Notice

Not all features listed here are supported by every camera.

You can view the functionality of your camera in the feature widget <sup>1</sup> of the *Camera Explorer*.

Please refer to the appropriate documentation.

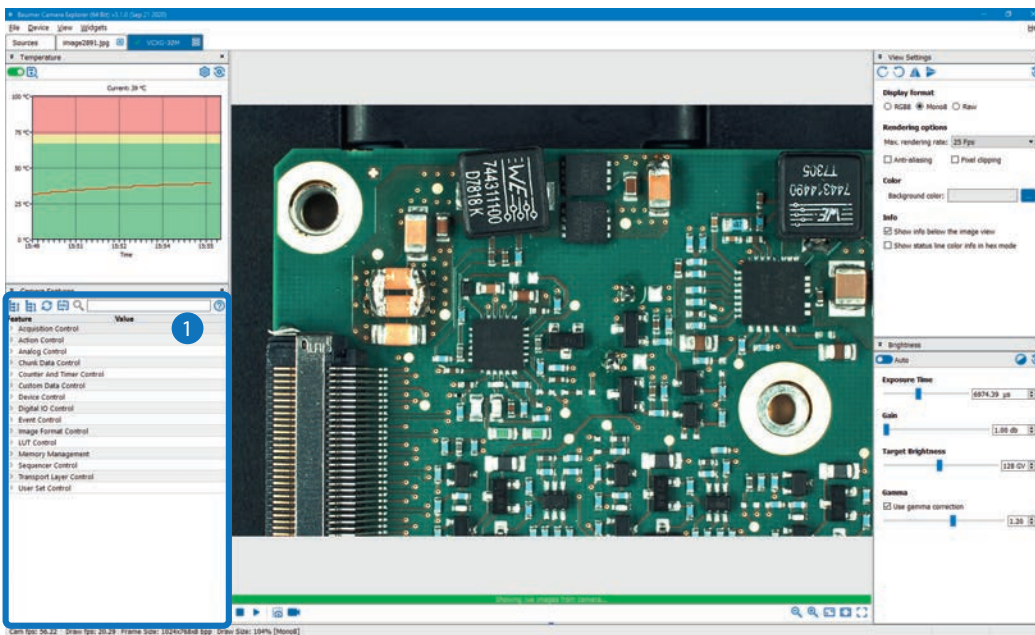

Camera Explorer ≥ v3.0 with highlighted feature widget

## Category: AcquisitionControl

This chapter describes all features related to image acquisition, including the trigger and exposure control.

### 7.3.1 AcquisitionAbort

The acquisition abort process is a special case in which the current acquisition is stopped. If an exposure is running, the exposure is aborted immediately and the image is not read out.

<b>Name</b>	AcquisitionAbort
<b>Category</b>	AcquisitionControl
<b>Interface</b>	ICommand
<b>Access</b>	Write only
<b>Unit</b>	-
<b>Values</b>	-

### 7.3.2 AcquisitionFrameCount

Number of frames to acquire in MultiFrame Acquisition mode

<b>Name</b>	AcquisitionFrameCount
<b>Category</b>	AcquisitionControl
<b>Interface</b>	IInteger
<b>Access</b>	Read / Write
<b>Unit</b>	-
<b>Values</b>	1 - 65535 (Increment: 1)

### 7.3.3 AcquisitionFrameRate

Controls the acquisition rate (in Hertz) at which the frames are captured.

#### Notice

For cameras that use the PTP functionality, the generation of the frame rate is based on the synchronized timestamp. This ensures the synchronous recording of frames.

The *PtpServoStatus* feature must be locked to use this functionality.

<b>Name</b>	AcquisitionFrameRate
<b>Category</b>	AcquisitionControl
<b>Interface</b>	IFloat
<b>Access</b>	Read / Write
<b>Unit</b>	Hz
<b>Values</b>	dedends on camera

### 7.3.4 AcquisitionFrameRateEnable

Enables the acquisition at the framerate specified by AcquisitionFrameRate.

<b>Name</b>	AcquisitionFrameRateEnable
<b>Category</b>	AcquisitionControl
<b>Interface</b>	IBoolean
<b>Access</b>	Read / Write
<b>Unit</b>	-
<b>Values</b>	true = 1 (On) false = 0 (Off)

### 7.3.5 AcquisitionMode

Sets the acquisition mode of the device. It defines mainly the number of frames to capture during an acquisition and the way the acquisition stops.

#### Notice

The camera must be stopped before this feature can be edited.

<b>Name</b>	AcquisitionMode						
<b>Category</b>	AcquisitionControl						
<b>Interface</b>	IEnumeration						
<b>Access</b>	Read / Write						
<b>Unit</b>	-						
<b>Values</b>	<table><tr><td>Continuous</td><td>Frames are captured continuously without external events until stopped with the AcquisitionStop command.</td></tr><tr><td>MultiFrame</td><td>In this mode a predefined number of frames will be captured after AcquisitionStart. The AcquisitionFrameCount controls the number of captured frames. Then the acquisition is automatically stopped.</td></tr><tr><td>SingleFrame</td><td>In this mode the camera is captured one frame after AcquisitionStart. Then the acquisition is stopped.</td></tr></table>	Continuous	Frames are captured continuously without external events until stopped with the AcquisitionStop command.	MultiFrame	In this mode a predefined number of frames will be captured after AcquisitionStart. The AcquisitionFrameCount controls the number of captured frames. Then the acquisition is automatically stopped.	SingleFrame	In this mode the camera is captured one frame after AcquisitionStart. Then the acquisition is stopped.
Continuous	Frames are captured continuously without external events until stopped with the AcquisitionStop command.						
MultiFrame	In this mode a predefined number of frames will be captured after AcquisitionStart. The AcquisitionFrameCount controls the number of captured frames. Then the acquisition is automatically stopped.						
SingleFrame	In this mode the camera is captured one frame after AcquisitionStart. Then the acquisition is stopped.						

### 7.3.6 AcquisitionStart

Once image acquisition has started, the camera processes the images in three steps:

- Determining the current set of image parameters
- Sensor exposure
- Readout from the sensor.

This process is then repeated until the camera is stopped.

#### Notice

Certain settings which affect the image format can only be adjusted if the camera is stopped.

This includes:

- PixelFormat
- Region of Interest (OffsetX / OffsetY / Width / Height)

<b>Name</b>	AcquisitionStart
<b>Category</b>	AcquisitionControl
<b>Interface</b>	ICommand
<b>Access</b>	Write only
<b>Unit</b>	-
<b>Values</b>	-

### 7.3.7 AcquisitionStatus

Reads the state of the internal acquisition signal selected using *AcquisitionStatusSelector*.

<b>Name</b>	AcquisitionStatus
<b>Category</b>	AcquisitionControl
<b>Interface</b>	IBoolean
<b>Access</b>	Read only
<b>Unit</b>	-
<b>Values</b>	true = 1 (On) false = 0 (Off)

### 7.3.8 AcquisitionStatusSelector

Selects the internal acquisition signal to read using AcquisitionStatus.

<b>Name</b>	AcquisitionStatusSelector
<b>Category</b>	AcquisitionControl
<b>Interface</b>	IEnumeration
<b>Access</b>	Read / Write
<b>Unit</b>	-
<b>Values</b>	Acquisition Active      Device is currently doing an acquisition of one or many frames. Acquisition Trigger Wait      Device is currently waiting for a trigger for the capture of one or many frames.

### 7.3.9 AcquisitionStop

Stops the Acquisition of the device at the end of the current Frame.

<b>Name</b>	AcquisitionStop
<b>Category</b>	AcquisitionControl
<b>Interface</b>	ICommand
<b>Access</b>	Write only
<b>Unit</b>	-
<b>Values</b>	-

### 7.3.10 ExposureAuto (except .PTP / .I.PTP)

Sets the automatic exposure mode when ExposureMode is Timed. The exact algorithm used to implement this control is device-specific.

#### Notice

For rolling shutter cameras, the function is only available in Sensor Shutter Mode: *Rolling Shutter*.

<b>Name</b>	ExposureAuto	
<b>Category</b>	AcquisitionControl	
<b>Interface</b>	IEnumeration	
<b>Access</b>	Read / Write	
<b>Unit</b>	-	
<b>Values</b>	Continuous	Exposure duration is constantly adapted by the device to maximize the dynamic range.
	Off	Exposure duration is user controlled using ExposureTime.
	Once	Exposure duration is adapted once by the device. Once it has converged, it returns to the Off state.

### 7.3.11 ExposureMode

Sets the operation mode of the Exposure (or shutter).

<b>Name</b>	ExposureMode	
<b>Category</b>	AcquisitionControl	
<b>Interface</b>	IEnumeration	
<b>Access</b>	Read / Write	
<b>Unit</b>	-	
<b>Values</b>	Timed	Timed exposure. The exposure duration time is set using the ExposureTime or ExposureAuto features and the exposure starts with the FrameStart or LineStart.

### 7.3.12 ExposureTime

On exposure of the sensor, the inclination of photons produces a charge separation on the semiconductors of the pixels. This results in a voltage difference, which is used for signal extraction.

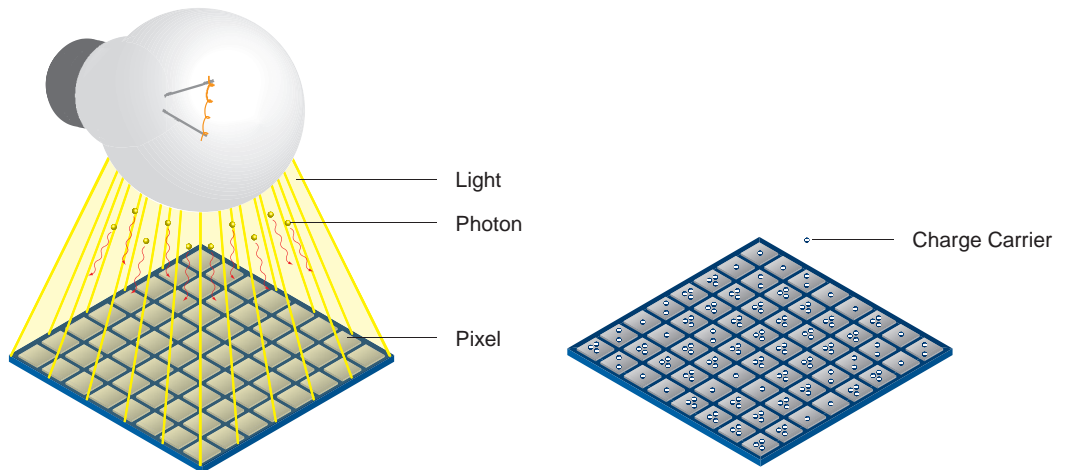

The signal strength is influenced by the incoming amount of photons. It can be increased by increasing the exposure time ( $t_{\text{exposure}}$ ).

<b>Name</b>	ExposureTime
<b>Category</b>	AcquisitionControl
<b>Interface</b>	IFloat
<b>Access</b>	Read / Write
<b>Unit</b>	$\mu\text{s}$
<b>Values</b>	see tables below

#### Notice

**Only for cameras with rolling shutter sensors!**

The modification of the Exposure Time is done by reconfiguration of the sensor.

If the modification occurs during a sensor readout, the update will be delayed until the end of the current readout.

#### Notice

Due to the sensor, fixed pattern noise effects can occur at high exposure times. You can counteract this by setting the gain to a value of approximately 1.5 and reducing the exposure time accordingly.

#### Notice

In order to set a short exposure time for cameras with release 2.1, the *Short Exposure Time Enable* feature must be enabled.

If the feature *Short Exposure Time Enable* is enabled and the exposure time is changed e.g. from 20  $\mu\text{sec}$  to lower than 15  $\mu\text{sec}$ , this will change the internal parameters of the sensors and the sensor needs to reinitialize.

This initialization sequence takes about 50 msec. This process is only necessary, if the exposure range is changed. If the new exposure value is within the default exposure range, no initialization is necessary.

#### Notice

It is not possible to use the *Sequencer* when the feature *Short Exposure Time Enable* is enabled.



On Baumer CX cameras, the exposure time can be set within the following ranges (step size 1 µsec):

### 7.3.12.1 VCXG /.XC / .I/ .I.XT / .PTP / .I.PTP

Camera Type	$t_{\text{exposure min}}^*$ [µsec]	$t_{\text{non-selectable range}}^1)$ ExposureTimeGapMin - Exposure- TimeGapMax	$t_{\text{exposure max}}$ [sec]
	Release 1.1   Release 2.0   Release 2.1   Release 2.2   Release 3.0   Release 4.0   Release 4.1		
<b>Monochrome</b>			
VCXG-02M	20   20   20   x   20   x		1
VCXG-04M	x   x   1   x   1   x		60
VCXG-13M / .I/.I.XT	20   20   20   x   20   x		1
VCXG-13NIR	x   x   x   x   20   x		1
VCXG-14SWIR.XC	x   x   x   x   x   x   20		60
VCXG-15M / .I/.I.XT	x   x   1   x   1   x		60
VCXG-22M.R	x   x   x   15   x   x		60
VCXG-23M	35   35   35   x   35   x		60
VCXG-24M	57   57   57   x   57   x		60
VCXG-25M / .I/.I.XT	20   20   20   x   20   x		1
VCXG-32M / .I/.I.XT/.PTP/.I.PTP	50   50   1   x   1   x		60
VCXG-50MP	x   x   x   1   x   x		60
VCXG-51M / .XC / .I/.I.XT/.PTP/.I.PTP	43   43   1   x   1   x		60
VCXG-53M / .I/.I.XT	20   20   20   x   x		1
VCXG-53NIR	x   x   x   x   20   x		1
VCXG-65M.R	x   x   x   x   21   x		60
VCXG-82M / .I/.I.XT	x   x   x   x   x   1	4 - 22 µs	60
VCXG-91M	x   x   1   x   1   x		60
VCXG-124M / .I/.I.XT/.PTP/.I.PTP	60   60   1   x   1   x		60
VCXG-125M.R	x   x   x   85   85   x		60
VCXG-127M / .I/.I.XT	x   x   x   x   x   1	4 - 30 µs	60
VCXG-201M.R / .I/.I.XT	x   x   x   115   115   x		60
VCXG-204M	x   x   x   x   x   1	4 - 33 µs	60
VCXG-241M / .I/.I.XT	x   x   x   x   39   1	4 - 38 µs	60
<b>Color</b>			
VCXG-02C	20   20   20   x   20   x		1
VCXG-04C	x   x   1   x   1   x		60
VCXG-13C / .I/.I.XT	20   20   20   x   20   x		1
VCXG-15C / .I/.I.XT	x   x   1   x   1   x		60
VCXG-22C.R	x   x   x   15   x   x		60
VCXG-23C	35   35   35   x   35   x		60
VCXG-24C	57   57   57   x   57   x		60
VCXG-25C / .I/.I.XT	20   20   20   x   20   x		1
VCXG-32C / .I/.I.XT/.PTP/.I.PTP	50   50   1   x   1   x		60
VCXG-51C / .I/.I.XT/.PTP/.I.PTP	43   43   1   x   1   x		60
VCXG-53C / .I/.I.XT	20   20   20   x   20   x		1
VCXG-65C.R	x   x   x   x   21   x		60
VCXG-82C / .I/.I.XT	x   x   x   x   x   1	4 - 22 µs	60
VCXG-91C	x   x   1   x   1   x		60
VCXG-124C / .I/.I.XT/.PTP/.I.PTP	x   60   1   x   1   x		60
VCXG-125C.R	x   x   x   85   85   x		60
VCXG-127C / .I/.I.XT	x   x   x   x   x   1	4 - 30 µs	60
VCXG-91C	x   x   1   x   1   x		60
VCXG-201C.R / .I/.I.XT	x   x   x   115   115   x		60
VCXG-204C	x   x   x   x   x   1	4 - 33 µs	60
VCXG-241C / .I/.I.XT	x   x   x   x   39   1	4 - 38 µs	60

**Notice**

**VCXG-22M.R**  
**VCXG-22C.R**

In shutter mode *Global Reset* the exposure time can only be changed when the acquisition is stopped.

In the shutter mode *Rolling Shutter*, the acquisition does not have to be stopped.

<sup>\*)</sup> .I/.I.XT only Release 2.1 , 3.0  
<sup>\*\*) shutter mode *Global Reset*</sup>  
<sup>\*\*\*) shutter mode *Rolling Shutter*</sup>

<sup>1)</sup> range only relevant with activated *ShortExposureTimeEnable*

### 7.3.12.2 VCXU

Camera Type	$t_{\text{exposure min}}$ [ $\mu\text{sec}$ ]	$t_{\text{exposure max}}$ [sec]
<small>Release 1.1   Release 2.0   Release 2.1   Release 2.2   Release 2.3   Release 3.0</small>		
<b>Monochrome</b>		
VCXU-02M	30   20   x   x   x   20	1
VCXU-04M	x   x   1   x   x   1   1	60
VCXU-13M	30   20   x   x   x   20	1
VCXU-15M	x   x   1   x   x   1	60
VCXU-22M.R	x   x   x   135   x   135* x   x   x   15   x   15**	1.698* 60**
VCXU-23M	28   28   28   x   x   28	60
VCXU-24M	57   57   57   x   x   57	60
VCXU-25M	30   20   20   x   x   20	1
VCXU-31M	26   26   1   x   x   1	60
VCXU-32M	50   50   1   x   x   1	60
VCXU-50M	45   30   1   x   x   1	60
VCXU-50MP	x   x   x   1   x   x	60
VCXU-51M	43   43   1   x   x   1	60
VCXU-53M	30   20   20   x   x   20	1
VCXU-65M.R	x   x   x   x   75   75* x   x   x   14   14   14**	60
VCXU-90M	x   37   1   x   x   1	60
VCXU-91M	x   x   1   x   x   1	60
VCXU-123M	37   37   1   x   x   1	60
VCXU-124M	x   x   1   x   x   1	60
VCXU-125M.R	x   x   x   44   x   44	60
VCXU-201M.R	x   x   x   53   x   53	60
<b>Color</b>		
VCXU-02C	30   20   x   x   x   20	1
VCXU-04C	x   x   1   x   x   1	60
VCXU-13C	30   20   x   x   x   20	1
VCXU-15C	x   x   1   x   x   1	60
VCXU-22C.R	x   x   x   135   x   135* x   x   x   15   x   15**	1.698* 60**
VCXU-23C	45   28   28   x   x   28	60
VCXU-24C	57   57   57   x   x   57	60
VCXU-25C	30   20   20   x   x   20	1
VCXU-31C	26   26   1   x   x   1	60
VCXU-32C	50   50   1   x   x   1	60
VCXU-50C	30   30   1   x   x   1	60
VCXU-51C	43   43   1   x   x   1	60
VCXU-53C	30   20   20   x   x   20	1
VCXU-65C.R	x   x   x   x   75   75* x   x   x   14   14   14**	60
VCXU-90C	x   37   1   x   x   1	60
VCXU-91C	x   x   1   x   x   1	60
VCXU-123C	x   37   1   x   x   1	60
VCXU-124C	x   x   1   x   x   1	60
VCXU-125C.R	x   x   x   44   x   44	60
VCXU-201C.R	x   x   x   53   x   53	60

#### Notice

#### VCXU-22M.R / VCXU-22C.R

In shutter mode *Global Reset* the exposure time can only be changed when the acquisition is stopped.

In the shutter mode *Rolling Shutter*, the acquisition does not have to be stopped.

\*) shutter mode *Global Reset*

\*\*) shutter mode *Rolling Shutter*

### 7.3.13 ExposureTimeGapMax (≥ Rel. 4 only)

Returns the maximum value of the exposure time gap.

<b>Name</b>	ExposureTimeGapMax
<b>Category</b>	AcquisitionControl
<b>Interface</b>	IFloat
<b>Access</b>	Read only
<b>Unit</b>	μs
<b>Values</b>	0 - 2,000,000.000000 (Increment: 1.00)

### 7.3.14 ExposureTimeGapMin (≥ Rel. 4 only)

Returns the minimum value of the exposure time gap.

<b>Name</b>	ExposureTimeGapMin
<b>Category</b>	AcquisitionControl
<b>Interface</b>	IFloat
<b>Access</b>	Read only
<b>Unit</b>	μs
<b>Values</b>	0 - 2,000,000.000000 (Increment: 1.00)

### 7.3.15 ReadoutMode

Specifies the operation mode of the readout for the acquisition.

Image acquisition consists of two separate procedures carried out in succession.

Exposing the pixels on the photosensitive surface of the sensor is only the first part of the image acquisition process. Once this first step is completed, the pixels are read out.

The exposure time ( $t_{\text{exposure}}$ ) can be adjusted by the user, however, the time needed for the readout ( $t_{\text{readout}}$ ) is determined by the particular sensor and image format in use.

The cameras can be operated sequential or overlapped depending on the mode and the combination of exposure and readout times used:

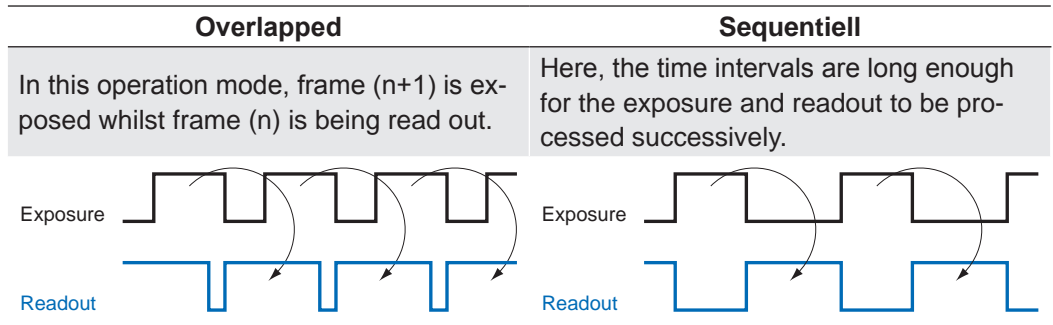

If the camera is unable to process incoming trigger signals, which means the camera should be triggered within the interval  $t_{\text{notready}}$ , these triggers are skipped. The user will be informed about this fact by means of the event "TriggerSkipped".

Depending on the ReadoutMode  $t_{\text{notready}}$  is determined as follows:

#### ReadoutMode: Overlapped

$$t_{\text{notready}} = t_{\text{exposure}(n)} + (t_{\text{readout}(n)} - t_{\text{exposure}(n+1)}) + t_{\text{Triggerdelay}}$$

#### ReadoutMode: Sequentiell

$$t_{\text{notready}} = t_{\text{exposure}(n)} + t_{\text{readout}(n)} + t_{\text{Triggerdelay}}$$

#### Notice

In Sensor Shutter Mode: *Global Reset*  $t_{\text{TriggerDelay}}$  is constant and independent of image settings.

In Sensor Shutter Mode: *Rolling Shutter*  $t_{\text{TriggerDelay}}$  is not constant (expect  $t_{\text{exposure}} < T_{\text{Readout}}$ )  $T_{\text{TriggerDelay}}$  depends on image settings like:

- *ExposureTime*
- *PixelFormat*
- ...

<b>Name</b>	ReadoutMode	
<b>Category</b>	AcquisitionControl	
<b>Interface</b>	IEnumeration	
<b>Access</b>	Read / Write	
<b>Unit</b>	-	
<b>Values</b>	Overlapped	Overlapped ReadOutMode
	Sequential	Sequential ReadoutMode

### 7.3.16 ShortExposureTimeEnable

Controls if short exposure time should be supported.

#### Notice

It is not possible to use the *Sequencer* when the feature *Short Exposure Time Enable* is enabled.

<b>Name</b>	ShortExposureTimeEnable
<b>Category</b>	AcquisitionControl
<b>Interface</b>	IBoolean
<b>Access</b>	Read only
<b>Unit</b>	-
<b>Values</b>	true = 1 (On) false = 0 (Off)

### 7.3.17 TriggerActivation

Specifies the activation mode of the trigger.

<b>Name</b>	TriggerActivation
<b>Category</b>	AcquisitionControl
<b>Interface</b>	IEnumeration
<b>Access</b>	Read / Write
<b>Unit</b>	-
<b>Values</b>	FallingEdge      Specifies that the trigger is considered valid on the falling edge of the source signal. RisingEdge        Specifies that the trigger is considered valid on the rising edge of the source signal.

### 7.3.18 TriggerDelay

Specifies the delay in microseconds (us) to apply after the trigger reception before activating it.

<b>Name</b>	TriggerDelay
<b>Category</b>	AcquisitionControl
<b>Interface</b>	IFloat
<b>Access</b>	Read / Write
<b>Unit</b>	µs
<b>Values</b>	0 - 2,000,000.000000 (Increment: 1.00)

### 7.3.19 TriggerMode

Controls if the selected trigger is active.

<b>Name</b>	TriggerMode	
<b>Category</b>	AcquisitionControl	
<b>Interface</b>	IEnumeration	
<b>Access</b>	Read / Write	
<b>Unit</b>	-	
<b>Values</b>	Off	Disables the selected trigger.
	On	Enable the selected trigger.

#### V CXG / V CXU (only cameras with rolling shutter sensors)

The sensor TriggerMode depends on the SensorShutterMode.

Camera Type (Sensor)	Trigger Mode = On		Trigger Mode = Off	
	Shutter Mode	Readout Mode	Shutter Mode	Readout Mode
<b>Monochrome / Color</b>				
VCXG-22M.R	Global Reset	Non-overlapped	Global Reset	Non-overlapped
VCXG-22C.R	Rolling	Non-overlapped	Rolling	Overlapped
VCXU-22M.R	Global Reset	Non-overlapped	Global Reset	Non-overlapped
VCXU-22C.R	Rolling	Non-overlapped	Rolling	Overlapped
VCXG-65M.R	Global Reset	Non-overlapped	Global Reset	Non-overlapped
VCXG-65C.R	Rolling	Non-overlapped	Rolling	Overlapped
VCXU-65M.R	Global Reset	Non-overlapped	Global Reset	Non-overlapped
VCXU-65C.R	Rolling	Non-overlapped	Rolling	Overlapped
VCXG-201M.R (.I)	Global	Non-overlapped	Global Reset	Non-overlapped
VCXG-201C.R (.I)	Rolling	Non-overlapped	Rolling	Overlapped
VCXG-125M.R	Global Reset	Non-overlapped	Global Reset	Non-overlapped
VCXG-125C.R	Rolling	Non-overlapped	Rolling	Overlapped
VCXU-125M.R	Global Reset	Non-overlapped	Global Reset	Non-overlapped
VCXU-125C.R	Rolling	Non-overlapped	Rolling	Overlapped
VCXU-201M.R	Global Reset	Non-overlapped	Global Reset	Non-overlapped
VCXU-201C.R	Rolling	Non-overlapped	Rolling	Overlapped

#### 7.3.19.1 Timings of the image transmission V CXG

##### Trigger Mode

The transfer of the first image starts after data for a complete packet size is stored in camera's TX memory. All further images start the transfer immediately after the first one is completed, if the camera works in burst mode with a high frame rate and the sensor acquires images faster than the interface can transfer. These additional pictures are not referenced to the time of the readout. If the sensor is triggered slowly enough, each image will behave like the first image.

##### Freerun Mode

The transfer of each image starts after data for a complete packet size is stored in the camera's TX memory. Since the sensor delivers more data than the interface can manage, depending on set ROI, images are repeatedly discarded and not transferred. Therefore, gaps of different sizes can be created via the GigE interface.

### 7.3.19.2 Timings of the image transmission VCXU

#### Trigger Mode

All images are written from sensor into memory as long as free buffers are available. If this burst memory is full, all following images are discarded by the sensor. The transfer of the first image starts with a small delay (about 2 lines). The data is read from the memory and transferred to the interface. The interface can now control reading from memory. Depending on the USB configuration (ThroughputLimit, blank packages), the interface can retrieve the data quickly enough or is lagging.

#### Freerun Mode

Only one alternating buffer is provided in the memory. The first image is written into the memory and immediately transferred to the interface with a small delay. The second image from the sensor is written into another buffer, which would be transferred immediately afterwards. If the interface is too slow due to the current configuration and the first image has not yet been transferred completely when the third image is already received from the sensor, the third image would overwrite the second one and would be transferred via the interface next.

### 7.3.20 TriggerOverlap

Specifies the type trigger overlap permitted with the previous frame.

<b>Name</b>	TriggerOverlap
<b>Category</b>	AcquisitionControl
<b>Interface</b>	IEnumeration
<b>Access</b>	Read / Write
<b>Unit</b>	-
<b>Values</b>	Read Out    Trigger is accepted immediately after the exposure period.

### 7.3.21 TriggerSelector

Selects the type of trigger to configure.

<b>Name</b>	TriggerSelector
<b>Category</b>	AcquisitionControl
<b>Interface</b>	IEnumeration
<b>Access</b>	Read / Write
<b>Unit</b>	-
<b>Values</b>	Frame Start    Selects the type of trigger to configure.

### 7.3.22 TriggerSoftware

Generates a internal trigger. *TriggerSource* must be set to Software.

<b>Name</b>	TriggerSoftware
<b>Category</b>	AcquisitionControl
<b>Interface</b>	ICommand
<b>Access</b>	Write only
<b>Unit</b>	-
<b>Values</b>	-

### 7.3.23 TriggerSource

Specifies the internal signal or physical input Line to use as the trigger source. The selected trigger must have its *TriggerMode* set to On.

<b>Name</b>	TriggerSource
<b>Category</b>	AcquisitionControl
<b>Interface</b>	IEnumeration
<b>Access</b>	Read / Write
<b>Unit</b>	-
<b>Values</b>	see table below

	VCXG / .XC / .PTP	VCXG.I/.XT / .PTP	VCXU
Action1	<input checked="" type="checkbox"/>	<input checked="" type="checkbox"/>	<input type="checkbox"/>
All	<input checked="" type="checkbox"/>	<input checked="" type="checkbox"/>	<input checked="" type="checkbox"/>
Line0	<input checked="" type="checkbox"/>	<input checked="" type="checkbox"/>	<input checked="" type="checkbox"/>
Line1	<input checked="" type="checkbox"/>	<input checked="" type="checkbox"/>	<input checked="" type="checkbox"/>
Line2	<input checked="" type="checkbox"/>	<input checked="" type="checkbox"/>	<input checked="" type="checkbox"/>
Line3	<input checked="" type="checkbox"/>	<input checked="" type="checkbox"/>	<input checked="" type="checkbox"/>
Line4	<input type="checkbox"/>	<input checked="" type="checkbox"/>	<input type="checkbox"/>
Line5	<input type="checkbox"/>	<input checked="" type="checkbox"/>	<input type="checkbox"/>
Line6	<input type="checkbox"/>	<input checked="" type="checkbox"/>	<input type="checkbox"/>
Line7	<input type="checkbox"/>	<input checked="" type="checkbox"/>	<input type="checkbox"/>
Off	<input checked="" type="checkbox"/>	<input checked="" type="checkbox"/>	<input checked="" type="checkbox"/>
Software	<input checked="" type="checkbox"/>	<input checked="" type="checkbox"/>	<input checked="" type="checkbox"/>



## 7.1 Category: Action Control (GigE only)

Category that contains the Action control features.

### 7.1.1 ActionDeviceKey

Provides the device key that allows the device to check the validity of action commands. The device internal assertion of an action signal is only authorized if the *ActionDeviceKey* and the action device key value in the protocol message are equal.

<b>Name</b>	ActionDeviceKey
<b>Category</b>	ActionControl
<b>Interface</b>	Integer
<b>Access</b>	Write only
<b>Unit</b>	HexNumber
<b>Values</b>	0 - 4294967295 (Increment: 1)

### 7.1.2 ActionGroupKey

Provides the key that the device will use to validate the action on reception of the action protocol message.

<b>Name</b>	ActionGroupKey
<b>Category</b>	ActionControl
<b>Interface</b>	Integer
<b>Access</b>	Read / Write
<b>Unit</b>	HexNumber
<b>Values</b>	0 - 4294967295 (Increment: 1)

### 7.1.3 ActionGroupMask

Provides the mask that the device will use to validate the action on reception of the action protocol message.

<b>Name</b>	ActionGroupMask
<b>Category</b>	ActionControl
<b>Interface</b>	Integer
<b>Access</b>	Read / Write
<b>Unit</b>	HexNumber
<b>Values</b>	0 - 4294967295 (Increment: 1)

### 7.1.4 ActionSelector

Selects to which Action Signal further Action settings apply.

<b>Name</b>	ActionSelector
<b>Category</b>	ActionControl
<b>Interface</b>	Integer
<b>Access</b>	Read / Write
<b>Unit</b>	-
<b>Values</b>	1 - 1 (Increment: 1)

## 7.2 Category: AnalogControl

Features in this chapter describes how to influence the analog features of an image, such as gain, black level, brightness correction and gamma.

### 7.2.1 BalanceWhiteAuto (color cameras only)

Controls the mode for automatic white balancing between the color channels. The white balancing ratios are automatically adjusted.

<b>Name</b>	BalanceWhiteAuto	
<b>Category</b>	AnalogControl	
<b>Interface</b>	IEnumeration	
<b>Access</b>	Read / Write	
<b>Unit</b>	-	
<b>Values</b>	Continuous	White balancing is constantly adjusted by the device.
	Off	White balancing is off.
	Once	White balancing is automatically adjusted once by the device. Once it has converged, it automatically returns to the Off state. The levelling can take several images.
<b>Notice</b> When images are acquired in trigger mode, the white balance affects on the next acquired image.		

### 7.2.2 BlackLevel

Controls the analog black level as an absolute physical value. This represents a DC offset applied to the video signal.

<b>Name</b>	BlackLevel
<b>Category</b>	AnalogControl
<b>Interface</b>	IFloat
<b>Access</b>	Read / Write
<b>Unit</b>	-
<b>Values</b>	see tables below (Increment: 1.00)

### 7.2.2.1 VCXG / .XC / .I / .I.XT / .PTP / .I.PTP

Camera Type	Black Level
<b>Monochrome / Color</b>	
VCXG-02M / VCXG-02C	0 ... 63 DN10
VCXG-04M / VCXG-04C	0 ... 255 DN12
VCXG-13M / .I / .I.XT / VCXG-13C / .I / .I.XT / VCXG-13NIR	0 ... 63 DN10
VCXG-14SWIR.XC	0 ... 255 DN12
VCXG-15M / .I / .I.XT / VCXG-15C / .I / .I.XT	0 ... 255 DN12
VCXG-22M.R / VCXG-22C.R	0 ... 255 DN12
VCXG-23M / VCXG-23C	0 ... 255 DN12
VCXG-24M / VCXG-24C	0 ... 255 DN12
VCXG-25M / .I / .I.XT / VCXG-25C / .I / .I.XT	0 ... 63 DN10
VCXG-32M / .I / .I.XT / .PTP / .I.PTP	0 ... 255 DN12
VCXG-32C / .I / .I.XT / .PTP / .I.PTP	0 ... 255 DN12
VCXG-51MP	0 ... 255 DN12
VCXG-51M / .XC / .I / .I.XT / .PTP / .I.PTP	0 ... 255 DN12
VCXG-51C / .I / .I.XT / .PTP / .I.PTP	0 ... 255 DN12
VCXG-53M / .I / .I.XT / VCXG-53C / .I / .I.XT / VCXG-53NIR	0 ... 63 DN10
VCXG-65M.R / VCXG-65C.R	0 ... 255 DN12
VCXG-82M / .I / .I.XT / VCXG-82C / .I / .I.XT	0 ... 255 DN12
VCXG-91M / VCXG-91C	0 ... 255 DN12
VCXG-124M / .I / .I.XT / .PTP / .I.PTP	0 ... 255 DN12
VCXG-124C / .I / .I.XT / .PTP / .I.PTP	0 ... 255 DN12
VCXG-125M.R / VCXG-125C.R	0 ... 255 DN12
VCXG-127M / .I / .I.XT / VCXG-127C / .I / .I.XT	0 ... 255 DN12
VCXG-201M / .I / .I.XT / VCXG-201C / .I / .I.XT	0 ... 255 DN12
VCXG-204M / VCXG-204C	0 ... 255 DN12
VCXG-241M / .I / .I.XT / VCXG-241C / .I / .I.XT	0 ... 255 DN12

### 7.2.2.2 VCXU

Camera Type	Black Level
<b>Monochrome / Color</b>	
VCXU-02M / VCXU-02C	0 ... 63 DN10
VCXU-04M / VCXU-04C	0 ... 255 DN12
VCXU-13M / VCXU-13C	0 ... 63 DN10
VCXU-15M / VCXU-15C	0 ... 255 DN12
VCXU-22M.R / VCXU-22C.R	0 ... 255 DN12
VCXU-23M / VCXU-23C	0 ... 255 DN12
VCXU-24M / VCXU-24C	0 ... 255 DN12
VCXU-25M / VCXU-25C	0 ... 63 DN10
VCXU-31M / VCXU-31C	0 ... 255 DN12
VCXU-32M / VCXU-32C	0 ... 255 DN12
VCXU-50M / VCXU-50C	0 ... 255 DN12
VCXU-50MP	0 ... 255 DN12
VCXU-51M / VCXU-51C	0 ... 255 DN12
VCXU-53M / VCXU-53C	0 ... 63 DN10
VCXU-65M.R / VCXU-65C.R	0 ... 255 DN12
VCXU-90M / VCXU-90C	0 ... 255 DN12
VCXU-91M / VCXU-91C	0 ... 255 DN12
VCXU-123M / VCXU-123C	0 ... 255 DN12

VCXU-124M / VCXU-124C	0 ... 255 DN12
VCXU-125M.R / VCXU-125C.R	0 ... 255 DN12
VCXU-201M.R / VCXU-201C.R	0 ... 255 DN12

### 7.2.3 BlackLevelSelector

Selects which Black Level is controlled by the various Black Level features.

<b>Name</b>	BlackLevelSelector
<b>Category</b>	AnalogControl
<b>Interface</b>	IEnumeration
<b>Access</b>	Read / Write
<b>Unit</b>	-
<b>Values</b>	All                      Black Level will be applied to all channels or taps.

### 7.2.4 Gain

Motion blur is unacceptable in high quality image acquisition. Exposure times are therefore limited. However, this results in low output signals from the camera and dark images. To solve this issue, the signals can be amplified by a user-defined gain factor within the camera.

<b>Notice</b>
Increasing the gain factor also increases image noise.

Controls the selected gain as an absolute physical value.

<b>Name</b>	Gain
<b>Category</b>	AnalogControl
<b>Interface</b>	IIFloat
<b>Access</b>	Read / Write
<b>Unit</b>	-
<b>Values</b>	see tables below

### 7.2.4.1 VCXG / .XC / .I / .I.XT / .PTP / .I.PTP

Camera Type	Gain [dB] <sup>1)</sup>
<b>Monochrome</b>	
VCXG-02M	0...12   18
VCXG-04M	0...48
VCXG-13M / .I/.I.XT	0...12   18
VCXG-13NIR	0...18
VCXG-14SWIR.XC	0...48
VCXG-15M/ .I/.I.XT	0...48
VCXG-22M.R	0...48
VCXG-23M	0...48
VCXG-24M	0...48
VCXG-25M / .I/.I.XT	0...12   18
VCXG-32M / .I / .I.XT / .PTP / .I.PTP	0...48
VCXG-50MP	0...48
VCXG-51M / .XC / .I / .I.XT / .PTP / .I.PTP	0...48
VCXG-53M / .I/.I.XT	0...12   18
VCXG-65M.R	0...48
VCXG-82M / .I / .I.XT	0...18
VCXG-91M	0...48
VCXG-124M / .I / .I.XT / .PTP / .I.PTP	0...48
VCXG-125M.R	0...20
VCXG-127M / .I / .I.XT	0...48
VCXG-201M.R / .I / .I.XT	0...20
VCXG-204M	0...48
VCXG-241M / .I / .I.XT	0...48
<b>Color</b>	
VCXG-02C	0...12
VCXG-04C	0...48
VCXG-13C / .I/.I.XT	0...12
VCXG-15C/ .I/.I.XT	0...48
VCXG-22C.R	0...48
VCXG-23C	0...48
VCXG-24C	0...48
VCXG-25C / .I/.I.XT	0...12
VCXG-32C / .I / .I.XT / .PTP / .I.PTP	0...48
VCXG-51C / .I / .I.XT / .PTP / .I.PTP	0...48
VCXG-53C / .I/.I.XT	0...12
VCXG-53NIR	0...12
VCXG-65C.R	0...48
VCXG-82C / .I / .I.XT	0...18
VCXG-91C	0...48
VCXG-124C / .I / .I.XT / .PTP / .I.PTP	0...48
VCXG-125C.R	0...20
VCXG-127C / .I / .I.XT	0...48
VCXG-201C.R / .I / .I.XT	0...20
VCXG-204M	0...48
VCXG-241C / .I / .I.XT	0...48

<sup>1)</sup> Release 1.0 | ≥ Release 2.0

### 7.2.4.2 VCXU

Camera Type	Gain [dB] <sup>1)</sup>
<b>Monochrome</b>	
VCXU-02M	0...12   18
VCXU-04M	0...48
VCXU-13M	0...12   18
VCXU-15M	0...48
VCXU-22M.R	0...26
VCXU-23M	0...48
VCXU-24M	0...48
VCXU-25M	0...12   18
VCXU-31M	0...48
VCXU-32M	0...48
VCXU-50M	0...48
VCXU-50MP	0...48
VCXU-51M	0...48
VCXU-53M	0...12   18
VCXU-65M.R	0...48
VCXU-90M	0...48
VCXU-91M	0...48
VCXU-123M	0...48
VCXU-124M	0...48
VCXU-125M.R	0...20
VCXU-201M.R	0...20
<b>Color</b>	
VCXU-02C	0...12
VCXU-04C	0...48
VCXU-13C	0...12
VCXU-15C	0...48
VCXU-22C.R	0...26
VCXU-23C	0...48
VCXU-24C	0...48
VCXU-25C	0...12
VCXU-31C	0...48
VCXU-32C	0...48
VCXU-50C	0...48
VCXU-51C	0...48
VCXU-53C	0...12
VCXU-65C.R	0...48
VCXU-90C	0...48
VCXU-91C	0...48
VCXU-123C	0...48
VCXU-124C	0...48
VCXU-125C.R	0...20
VCXU-201C.R	0...20

<sup>1)</sup> Release 1.0 | ≥ Release 2.0

### 7.2.5 GainAuto (except .PTP / .I.PTP)

Sets the automatic gain control (AGC) mode. The exact algorithm used to implement AGC is device-specific.

<b>Name</b>	GainAuto	
<b>Category</b>	AnalogControl	
<b>Interface</b>	IEnumeration	
<b>Access</b>	Read / Write	
<b>Unit</b>	-	
<b>Values</b>	Continuous	Gain is constantly adjusted by the device.
	Off	Gain is User controlled using Gain.
	Once	Gain is automatically adjusted once by the device. Once it has converged, it automatically returns to the Off state. The levelling can take several images.

### 7.2.6 GainSelector

Selects which gain is controlled by the various gain feature.

<b>Name</b>	GainSelector	
<b>Category</b>	AnalogControl	
<b>Interface</b>	IEnumeration	
<b>Access</b>	Read / Write	
<b>Unit</b>	-	
<b>Values</b>	All	Gain will be applied to all channels or taps.
	Blue	Gain will be applied to the blue channel. (only color cameras)
	GreenBlue	Gain will be applied to the green blue channel. (only color cameras)
	GreenRed	Gain will be applied to the green red channel. (only color cameras)
	Red	Gain will be applied to the red channel. (only color cameras)

### 7.2.7 Gamma

This feature offer the possibility of compensating nonlinearity in the perception of light by the human eye.

For this correction, the corrected pixel intensity ( $Y'$ ) is calculated from the original intensity of the sensor's pixel ( $Y_{\text{original}}$ ) and correction factor  $\gamma$  using the following formula (in over-simplified version):

$$Y' = Y_{\text{original}}^{\gamma}$$

The correction factor  $\gamma$  is adjustable from 0.1 to 2.

The values of the calculated intensities are entered into the Look-Up-Table. Thereby previously existing values within the LUT will be overwritten.

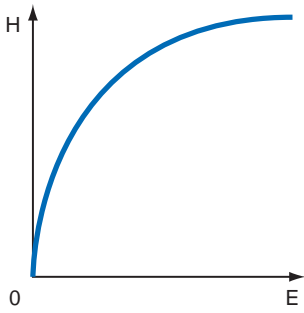

Non-linear perception of the human eye.  
 H - Perception of brightness  
 E - Energy of light

#### Notice

If the LUT feature is disabled on the software side, the gamma correction feature is disabled, too.

#### Notice

For cameras with long readout times (e.g.: VCXU-201M.R / VCXU-123M) may cause visual effects while setting a value for gamma and simultaneous image acquisition, because access to LUT is not locked against the pixel stream.

This can be prevented by stopping the camera (*AcquisitionStop*) before setting.

<b>Name</b>	Gamma
<b>Category</b>	AnalogControl
<b>Interface</b>	IFloat
<b>Access</b>	Read / Write
<b>Unit</b>	-
<b>Values</b>	0.1 - 2.0 (Increment: 0.10)



### 7.3 Category: AutoFeatureControl (≥ Release 3 only, except .PTP / .I.PTP)

Category that contains the auto feature control features.

#### General Information

Various auto features are available to affect the automatic adjustment of image brightness. Two methods are described below.

#### BrightAutoPriority = ExposureAuto

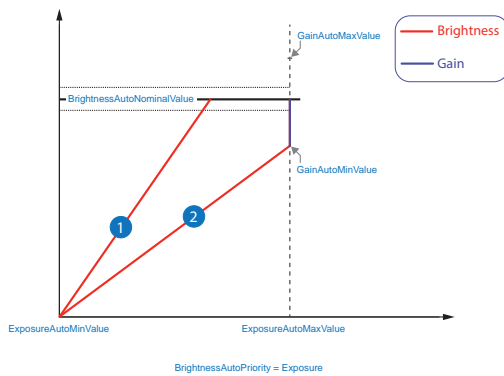

#### 1 Example 1

For image 1, increasing the brightness with *ExposureTime* is sufficient to achieve the *BrightnessAutoNominalValue*.

#### 2 Example 2

For image 2, increasing the brightness with *ExposureTime* is not enough to reach the value of *BrightnessAutoNominalValue*.

Therefore, the gain is increased after reaching *ExposureAutoMaxValue*.

#### BrightAutoPriority = GainAuto

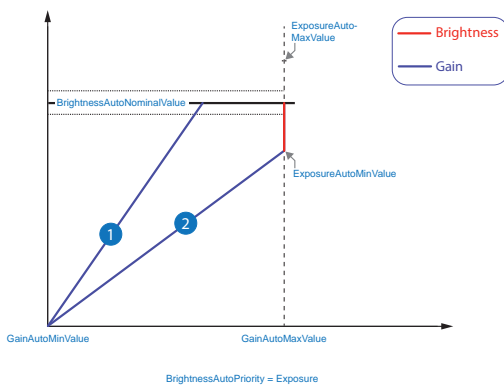

#### 1 Example 1

For image 1, increasing the brightness with *Gain* is sufficient to achieve the *BrightnessAutoNominalValue*.

#### 2 Example 2

For image 2, increasing the brightness with *Gain* is not enough to reach the value of *BrightnessAutoNominalValue*.

Therefore, the *ExposureTime* is increased after reaching *ExposureAutoMaxValue*.

## AutoFeature ROI - General Information

You can use the AutoFeature Region of Interest (ROI) function to predefine a so-called region of interest. This ROI is an area of pixels on the sensor.

This function is used if only the image data (e.g. brightness) of a particular region of the image is of interest. The calculated corrections will be applied to the entire image.

The AutoFeature ROI is specified using four values:

- AutoFeatureOffsetX - x-coordinate of the first relevant pixel
- AutoFeatureOffsetY - y-coordinate of the first relevant pixel
- AutoFeatureWidth - horizontal size of the Region
- AutoFeatureHeight - vertical size of the Region

## AutoFeature ROI in Full Frame

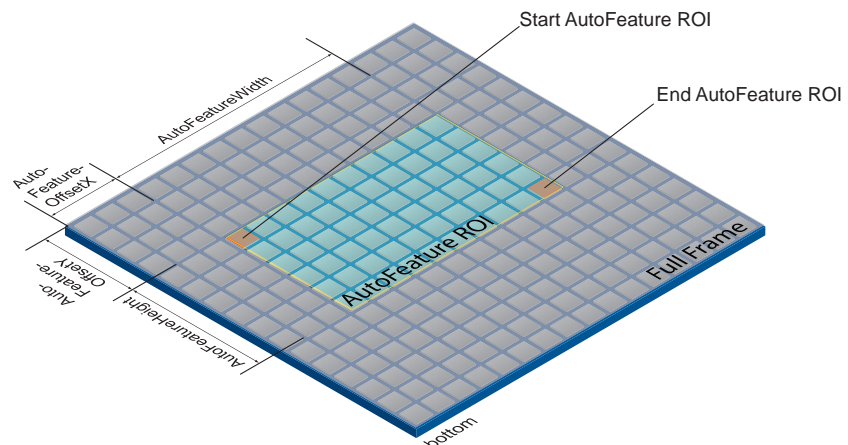

## AutoFeature ROI in an ROI

### Notice

It is possible to set an AutoFeature ROI in an ROI (Category: *ImageFormatControl*). The values that can be set for the AutoFeature ROI are adjusted accordingly.

The starting point for *AutoFeatureOffsetX* and *AutoFeatureOffsetY* is determined by the ROI (Category: *ImageFormatControl*).

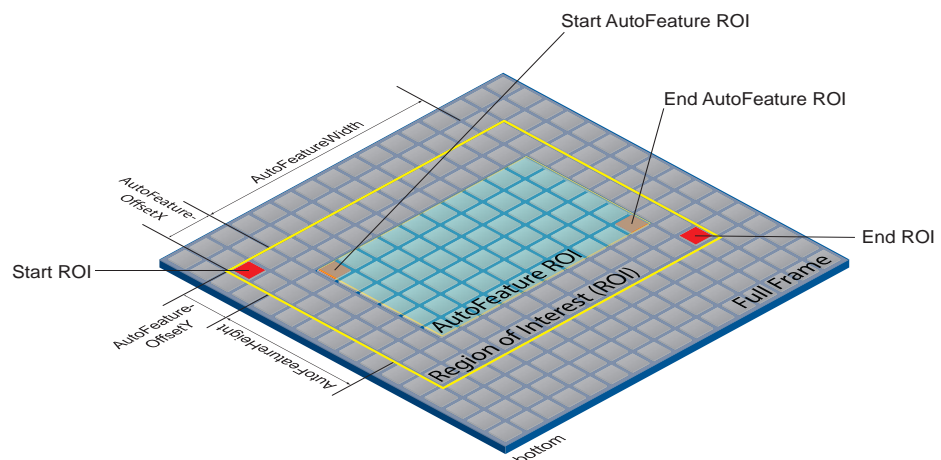

### 7.3.1 AutoFeatureHeight

Height of the selected Auto Feature Region (in pixels).

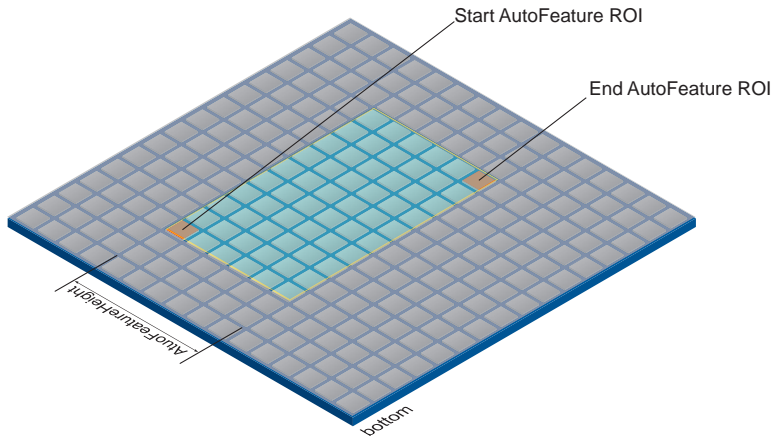

<b>Name</b>	AutoFeatureHeight
<b>Category</b>	AutoFeatureControl
<b>Interface</b>	Integer
<b>Access</b>	Read / Write
<b>Unit</b>	-
<b>Values</b>	<a href="#">see chapter „7.11.9 Height“ on page 157</a>

### 7.3.2 AutoFeatureOffsetX

Horizontal offset from the origin to the Auto Feature Region (in pixels).

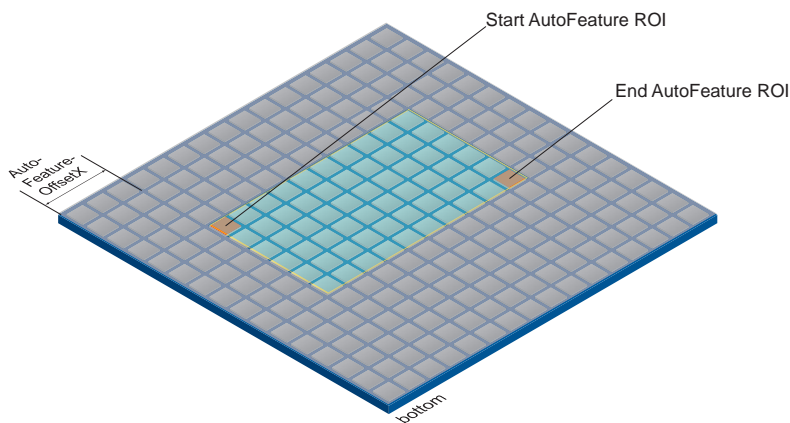

<b>Name</b>	AutoFeatureOffsetX
<b>Category</b>	AutoFeatureControl
<b>Interface</b>	Integer
<b>Access</b>	Read / Write
<b>Unit</b>	-
<b>Values</b>	0 - depends on <i>AutoFeatureWidth</i>

### 7.3.3 AutoFeatureOffsetY

Vertical offset from the origin to the Auto Feature Region (in pixels).

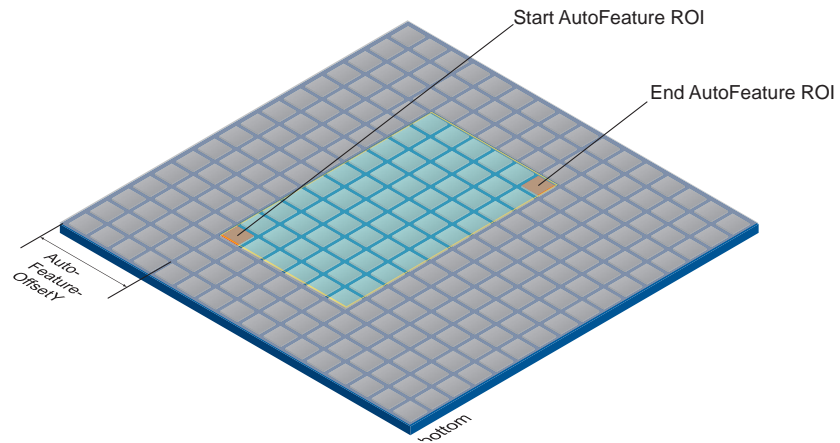

<b>Name</b>	AutoFeatureOffsetY
<b>Category</b>	AutoFeatureControl
<b>Interface</b>	IInteger
<b>Access</b>	Read / Write
<b>Unit</b>	-
<b>Values</b>	0 - depends on <i>AutoFeatureHeight</i>

### 7.3.4 AutoFeatureRegionMode

Controls the mode of the selected Auto Feature Region (AutoFeature ROI).

#### Notice

The camera must be stopped before this feature can be edited.

<b>Name</b>	AutoFeatureRegionMode	
<b>Category</b>	AutoFeatureControl	
<b>Interface</b>	IEnumeration	
<b>Access</b>	Read / Write	
<b>Unit</b>	-	
<b>Values</b>	Off	All settings of the selected AutoFeature ROI are automatically equal to the selected AutoFeatureRegionReference.
	On	The settings of the selected AutoFeature ROI are user defined. The AutoFeature is useable only if the AutoFeature ROI fits into the AutoFeatureregionReference of the AutoFeature.

### 7.3.5 AutoFeatureRegionReference

The Reference Region of interest. The Auto Feature Region is part of this region and all Auto Feature Region features are refs to this Reference Region.

<b>Name</b>	AutoFeatureRegionReference
<b>Category</b>	AutoFeatureControl
<b>Interface</b>	IEnumeration
<b>Access</b>	Read / Write
<b>Unit</b>	-
<b>Values</b>	Region0     The selected Auto Feature Region refs to Region 0.

### 7.3.6 AutoFeatureRegionSelector

Selects the Region of interest to control. The RegionSelector feature allows devices that are able to extract multiple regions out of an image, to configure the features of those individual regions independently.

<b>Name</b>	AutoFeatureRegionSelector
<b>Category</b>	AutoFeatureControl
<b>Interface</b>	IEnumeration
<b>Access</b>	Read / Write
<b>Unit</b>	-
<b>Values</b>	BalanceWhite-Auto     Selected features will control the region for Balance-WhiteAuto and ColorTransformationAuto algorithm. Brightness-Auto     Selected features will control the region for GainAuto and ExposureAuto algorithm.

### 7.3.7 AutoFeatureWidth

Width of the selected Auto Feature Region (in pixels).

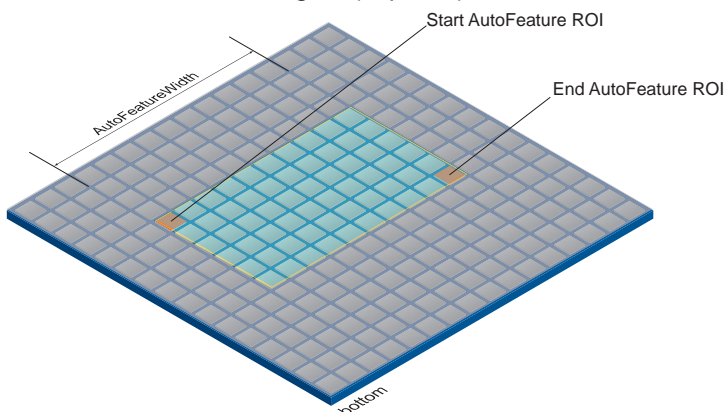

<b>Name</b>	AutoFeatureWidth
<b>Category</b>	AutoFeatureControl
<b>Interface</b>	IInteger
<b>Access</b>	Read / Write
<b>Unit</b>	-
<b>Values</b>	<a href="#">see chapter „7.11.24 Width“ on page 173</a>

### 7.3.8 BalanceWhiteAutoStatus

Status of BalanceWhiteAuto.

<b>Name</b>	AutoFeatureRegionSelector	
<b>Category</b>	AutoFeatureControl	
<b>Interface</b>	IEnumeration	
<b>Access</b>	Read only	
<b>Unit</b>	-	
<b>Values</b>	ColorGains-TooHigh	The BalanceWhiteAuto calculation failed since at least one of the calculated color gains exceeds the maximum value.
	Initial	BalanceWhiteAuto has never been started.
	Start	BalanceWhiteAuto is waiting for statistic data.
	Success	The last BalanceWhiteAuto calculation succeeded.
	Underrun	The BalanceWhiteAuto calculation failed since at least one color-channel shows invalid statistic data.

### 7.3.9 BrightnessAutoNominalValue

Sets the nominal value for brightness in percent of full scale. It will be adjust with consider the setting in BrightnessAutoPriority.

<b>Name</b>	BrightnessAutoNominalValue
<b>Category</b>	AutoFeatureControl
<b>Interface</b>	IFloat
<b>Access</b>	Read / Write
<b>Unit</b>	%
<b>Values</b>	5 - 95 (Increment: 1)

### 7.3.10 BrightnessAutoPriority

The feature set the highest priority auto feature to adjust the brightness.

#### Notice

When BrightnessAutoPriority is set to GainAuto, the brightening of the image is first achieved by increasing the gain. This can cause image noise, but the frame rate is not reduced.

<b>Name</b>	BrightnessAutoPriority	
<b>Category</b>	AutoFeatureControl	
<b>Interface</b>	IEnumeration	
<b>Access</b>	Read / Write	
<b>Unit</b>	-	
<b>Values</b>	ExposureAuto	ExposureAuto has highest priority and will be modified first.
	GainAuto	GainAuto has highest priority and will be modified first.

### BrightAutoPriority = ExposureAuto

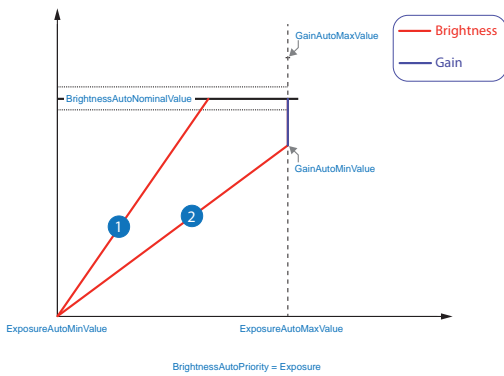

#### 1 Example 1

For image 1, increasing the brightness with *ExposureTime* is sufficient to achieve the *BrightnessAutoNominalValue*.

#### 2 Example 2

For image 2, increasing the brightness with *ExposureTime* is not enough to reach the value of *BrightnessAutoNominalValue*.

Therefore, the gain is increased after reaching *ExposureAutoMaxValue*.

### BrightAutoPriority = GainAuto

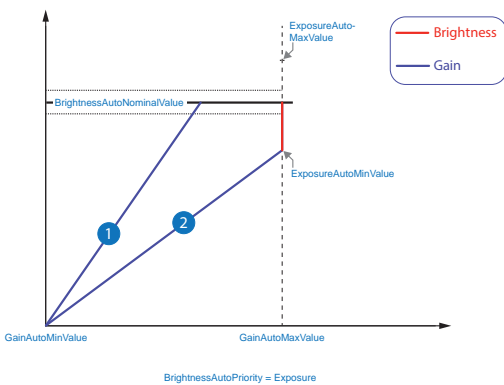

#### 1 Example 1

For image 1, increasing the brightness with *Gain* is sufficient to achieve the *BrightnessAutoNominalValue*.

#### 2 Example 2

For image 2, increasing the brightness with *Gain* is not enough to reach the value of *BrightnessAutoNominalValue*.

Therefore, the *ExposureTime* is increased after reaching *ExposureAutoMaxValue*.

### 7.3.11 ExposureAutoMaxValue

Maximal value of *ExposureTime* calculable by exposure auto algorithm.

<b>Name</b>	ExposureAutoMaxValue
<b>Category</b>	AutoFeatureControl
<b>Interface</b>	IFloat
<b>Access</b>	Read / Write
<b>Unit</b>	μs
<b>Values</b>	Adjustable value depends on the camera. <a href="#">see chapter „7.3.12 ExposureTime“ on page 68</a>

### 7.3.12 ExposureAutoMinValue

Minimal value of ExposureTime calculable by exposure auto algorithm.

#### Notice

An activated *ShortExposureTimeEnable* is ignored.

<b>Name</b>	ExposureAutoMinValue
<b>Category</b>	AutoFeatureControl
<b>Interface</b>	IFloat
<b>Access</b>	Read / Write
<b>Unit</b>	µs
<b>Values</b>	Adjustable value depends on the camera. <a href="#">see chapter „7.3.12 ExposureTime“ on page 68</a>

### 7.3.13 GainAutoMaxValue

Maximal value of Gain calculable by gain auto algorithm.

<b>Name</b>	GainAutoMaxValue
<b>Category</b>	AutoFeatureControl
<b>Interface</b>	IFloat
<b>Access</b>	Read / Write
<b>Unit</b>	-
<b>Values</b>	Adjustable value depends on the camera. <a href="#">see chapter „7.2.4 Gain“ on page 80</a>

### 7.3.14 GainAutoMinValue

Minimal value of Gain calculable by gain auto algorithm.

<b>Name</b>	GainAutoMinValue
<b>Category</b>	AutoFeatureControl
<b>Interface</b>	IFloat
<b>Access</b>	Read / Write
<b>Unit</b>	-
<b>Values</b>	Adjustable value depends on the camera. <a href="#">see chapter „7.2.4 Gain“ on page 80</a>



## 7.4 Category: ChunkDataControl

The chunk is a data packet that is generated by the camera and integrated into the payload (every image), if chunk mode is activated. These data include different settings for the respective image. This integrated data packet contains different image settings. Baumer GAPI can read the Image Info Header (Chunk).

There are three Chunk modes:

### Image Data

Only the image data are transferred, no Chunk data.

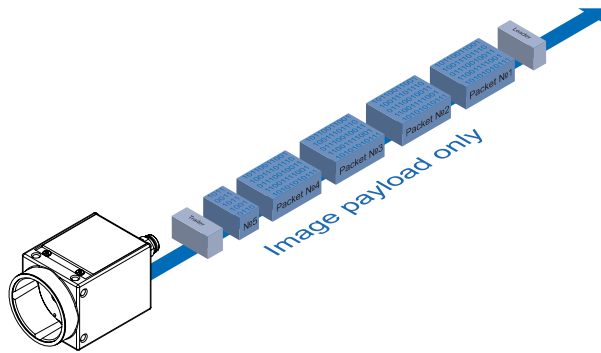

### Chunk Data

Only the chunk is transferred, no image data.

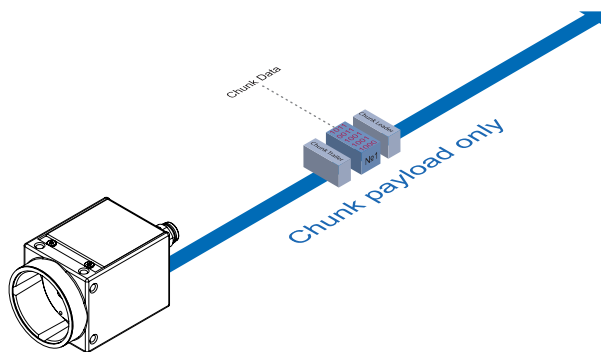

### Extended Chunk Data

Chunk data and image data are transferred. The Chunk Data are included in the last data packet.

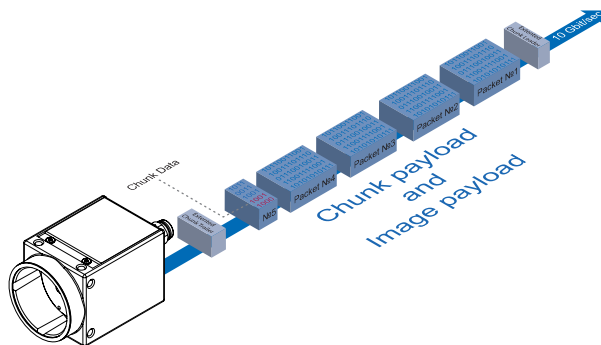

### 7.4.1 ChunkEnable

Enables the inclusion of the selected chunk data in the payload of the image.

#### Notice

You can choose the desired chunk under *Chunk Selector*.

#### Notice

The camera must be stopped before this feature can be edited.

<b>Name</b>	ChunkEnable
<b>Category</b>	ChunkDataControl
<b>Interface</b>	IBoolean
<b>Access</b>	Read / Write
<b>Unit</b>	-
<b>Values</b>	true = 1 (On) false = 0 (Off)

### 7.4.2 ChunkModeActive

Activation the inclusion of chunk data in the payload of the image.

#### Notice

The camera must be stopped before this feature can be edited.

<b>Name</b>	ChunkModeActive
<b>Category</b>	ChunkDataControl
<b>Interface</b>	IBoolean
<b>Access</b>	Read / Write
<b>Unit</b>	-
<b>Values</b>	true = 1 (On) false = 0 (Off)

### 7.4.3 ChunkSelector

Selects which chunk to enable or controlled.

<b>Name</b>	ChunkSelector
<b>Category</b>	ChunkDataControl
<b>Interface</b>	IEnumeration
<b>Access</b>	Read / Write
<b>Unit</b>	-
<b>Values</b>	see tables below

### 7.4.3.1 VCXG /.XC / .I / .I.XT / .PTP / .I.PTP / VCXU

This integrated data packet can contains adjustable settings for the image.

#### Release 1

Feature	Description
OffsetX	Horizontal offset from the origin to the area of interest (in pixels).
OffsetY	Vertical offset from the origin to the area of interest (in pixels).
Width	Returns the width of the image included in the payload.
Height	Returns the height of the image included in the payload.
PixelFormat	Returns the pixel format of the image included in the payload.
BinningHorizontal	Number of horizontal photo-sensitive cells to combine together.
BinningVertical	Number of vertical photo-sensitive cells to combine together.
ImageControl (subordinate features only together selectable)	
BrightnessCorrection	On/Off for the Brightness Correction.
DefectPixelCorrection	On/Off the correction of defect pixels.
LUTSelector	Selects the Chunk LUT.
LUTEnable	On/Off the selected LUT.
ReverseX	On/Off Flip horizontally the image sent by the device. The Region of interest is applied after the flipping
ReverseY	On/Off Flip vertically the image sent by the device. The Region of interest is applied after the flipping.
ExposureTime	Returns the exposure time used to capture the image.
BlackLevel	Returns the black level used to capture the image included in the payload.
GainSelector	Selects which Gain to retrieve data from.
Gain	Returns the gain used to capture the image.
FrameID	Returns the unique Identifier of the frame (or image) included in the payload.
Timestamp	Returns the Timestamp of the image included in the payload at the time of the FrameStart internal event.
DeviceTemperature	Device temperature in degrees Celsius (C). It is measured at the location selected by DeviceTemperatureSelector.
ChunkLineStatusAll	Returns the current status of all available Line signals at time of polling in a single bitfield.

## Release 2

Feature	Description
Binning (subordinate features only together selectable)	
BinningHorizontal	Number of horizontal photo-sensitive cells to combine together.
BinningHorizontalMode	Mode of Binnings Horizontal
BinningSelector	Where the Binning is calculated.  Region 0 (Binning is calculated in FPGA) Sensor (Binning is calculated in Sensor)
BinningVertical	Number of vertical photo-sensitive cells to combine together.
BinningVerticalMode	Mode of Binnings Horizontal
BlackLevel	Returns the black level used to capture the image included in the payload.
DeviceTemperature	Device temperature in degrees Celsius (C). It is measured at the location selected by DeviceTemperatureSelector.
ExposureTime	Returns the exposure time used to capture the image.
FrameID	Returns the unique Identifier of the frame (or image) included in the payload.
Gain	Returns the gain used to capture the image.
Height	Returns the height of the image included in the payload.
Image	Transmits the Image data in chunk block.
ImageControl (subordinate features only together selectable)	
BrightnessCorrection	On/Off for the Brightness Correction.
DefectPixelCorrection	On/Off the correction of defect pixels.
LUTSelector	Selects the Chunk LUT.
LUTEnable	On/Off the selected LUT.
ReverseX	On/Off Flip horizontally the image sent by the device. The Region of interest is applied after the flipping
ReverseY	On/Off Flip vertically the image sent by the device. The Region of interest is applied after the flipping.
LineStatusAll	Returns the current status of all available Line signals at time of polling in a single bitfield.
OffsetX	Horizontal offset from the origin to the area of interest (in pixels).
OffsetY	Vertical offset from the origin to the area of interest (in pixels).
PixelFormat	Returns the pixel format of the image included in the payload.
Timestamp	Returns the Timestamp of the image included in the payload at the time of the FrameStart internal event.
Width	Returns the width of the image included in the payload.

≥ Release 3

Feature	Description
Binning (subordinate features only together selectable)	
BinningHorizontal	Number of horizontal photo-sensitive cells to combine together.
BinningHorizontalMode	Mode of Binnings Horizontal
BinningSelector	Where the Binning is calculated.  Region 0 (Binning is calculated in FPGA) Sensor (Binning is calculated in Sensor)
BinningVertical	Number of vertical photo-sensitive cells to combine together.
BinningVerticalMode	Mode of Binnings Horizontal
BlackLevel	Returns the black level used to capture the image included in the payload.
CounterValue	Returns the current value of the selected Counter.
DeviceTemperature	Device temperature in degrees Celsius (C). It is measured at the location selected by DeviceTemperatureSelector.
ExposureTime	Returns the exposure time used to capture the image.
FrameID	Returns the unique Identifier of the frame (or image) included in the payload.
Gain	Returns the gain used to capture the image.
Height	Returns the height of the image included in the payload.
Image	Transmits the Image data in chunk block.
ImageControl (subordinate features only together selectable)	
BrightnessCorrection	On/Off for the Brightness Correction.
DefectPixelCorrection	On/Off the correction of defect pixels.
LUTSelector	Selects the Chunk LUT.
LUTEnable	On/Off the selected LUT.
ReverseX	On/Off Flip horizontally the image sent by the device. The Region of interest is applied after the flipping
ReverseY	On/Off Flip vertically the image sent by the device. The Region of interest is applied after the flipping.
LineStatusAll	Returns the current status of all available Line signals at time of polling in a single bitfield.
OffsetX	Horizontal offset from the origin to the area of interest (in pixels).
OffsetY	Vertical offset from the origin to the area of interest (in pixels).
PixelFormat	Returns the pixel format of the image included in the payload.
SequencerSetActive	Returns the active sequencer set.
Timestamp	Returns the Timestamp of the image included in the payload at the time of the FrameStart internal event.
TriggerID (only .PTP)	Returns the Trigger ID and the Trigger Source.  The Trigger ID counts the incoming triggers of the signal selected at <i>TriggerSource</i> . When the signal <i>Action1</i> is selected, the Request ID and the Source IP of the triggering device are output.
Width	Returns the width of the image included in the payload.

## 7.5 Category: ColorTransformationControl (color cameras only)

Category that contains the Color Transformation control features.

Oversimplified, color processing is realized by 4 modules.

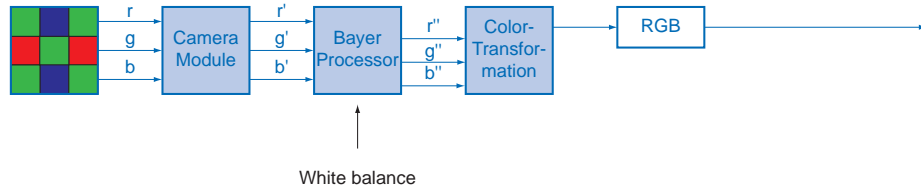

Color processing modules of color cameras.

The color signals  $r$  (red),  $g$  (green) and  $b$  (blue) of the sensor are amplified in total and digitized within the camera module.

Within the Bayer processor, the raw signals  $r'$ ,  $g'$  and  $b'$  are amplified by using of independent factors for each color channel. Then the missing color values are interpolated, which results in new color values ( $r''$ ,  $g''$ ,  $b''$ ).

The next step is the color transformation. Here the previously generated color signals  $r''$ ,  $g''$  and  $b''$  are converted to optimized RGB (Color adjustment as physical balance of the spectral sensitivities).

### 7.5.1 ColorTransformationAuto (≥ Release 3 only)

Controls the mode for automatic adjusting the gains of the active transformation matrix.

#### Notice

The *ColorTransformationAuto* feature can always be activated and the camera calculates the appropriate color matrices.

If the range of the estimated illumination to the measured reference illuminations exceeds a certain threshold, a white balance is triggered even if `BalanceWhiteAuto = off`.

However, the matrices in Image Format RAW are not used.

#### Notice

It is not possible to use the *Sequencer* when the feature *ColorTransformationAuto* is enabled.

<b>Name</b>	ColorTransformationAuto
<b>Category</b>	ColorTransformationControl
<b>Interface</b>	IEnumeration
<b>Access</b>	Read / Write
<b>Unit</b>	-

Color transformation is constantly adjusted by the device.

<b>Values</b>	Continuous	<p><b>Notice</b></p> <p>Color Gains not adjustable.</p>
	Off	Color transformation is user controlled using the various Colortransformation features.
	Once	Color transformation is automatically adjusted once by the device. Once it has converged, it automatically returns to the Off state.
		<p><b>Notice</b></p> <p>Color Gains not adjustable.</p>

### 7.5.2 ColorTransformationEnable

Activates the selected Color Transformation module.

<b>Name</b>	ColorTransformationEnable
<b>Category</b>	ColorTransformationControl
<b>Interface</b>	IBoolean
<b>Access</b>	Read only
<b>Unit</b>	-
<b>Values</b>	true = 1 (On) false = 0 (Off)

### 7.5.3 ColorTransformationFactoryListSelector

Selects the OptimizedMatrix for the desired color temperature. All calculated color values are based on the sRGB color space.

When setting an OptimizedMatrix, the ColorGains are also set for the white point matching the light.

#### Notice

We recommend to carry out a white balance after setting a matrix.

<b>Name</b>	ColorTransformationFactoryListSelector
<b>Category</b>	ColorTransformationControl
<b>Interface</b>	IEnumeration
<b>Access</b>	Read / Write
<b>Unit</b>	-
<b>Values</b>	OptimizedMatrix-For3000K      Matrix is tuned to the color temperature of 3000K. OptimizedMatrix-For5000K      Matrix is tuned to the color temperature of 5000K. OptimizedMatrix-For6500K      Matrix is tuned to the color temperature of 6500K. OptimizedMatrix-For9500K      Matrix is tuned to the color temperature of 9500K.

### 7.5.4 ColorTransformationOutputColorSpace

Output the color space of the camera.

<b>Name</b>	ColorTransformationOutputColorSpace
<b>Category</b>	ColorTransformationControl
<b>Interface</b>	IString
<b>Access</b>	Read only
<b>Unit</b>	-
<b>Values</b>	Color space

### 7.5.5 ColorTransformationResetToFactoryList

Resets the ColorTransformation to the selected ColorTransformationFactoryList.

<b>Name</b>	ColorTransformationResetToFactoryList
<b>Category</b>	ColorTransformationControl
<b>Interface</b>	ICommand
<b>Access</b>	Write only
<b>Unit</b>	-
<b>Values</b>	-

### 7.5.6 ColorTransformationValue

Represents the value of the selected Gain factor inside the Transformation matrix.

<b>Name</b>	ColorTransformationValue
<b>Category</b>	ColorTransformationControl
<b>Interface</b>	IFloat
<b>Access</b>	Read only
<b>Unit</b>	-
<b>Values</b>	-8.0 – 8.0 (Increment: 1.00)

### 7.5.7 ColorTransformationValueSelector

Selects the Gain factor of the Transformation matrix to access in the selected Color Transformation module.

<b>Name</b>	ColorTransformationValueSelector
<b>Category</b>	ColorTransformationControl
<b>Interface</b>	IEnumeration
<b>Access</b>	Read / Write
<b>Unit</b>	-
<b>Values</b>	<ul style="list-style-type: none"><li>▪ Gain00</li><li>▪ Gain01</li><li>▪ Gain02</li><li>▪ Gain10</li><li>▪ Gain11</li><li>▪ Gain12</li><li>▪ Gain20</li><li>▪ Gain21</li><li>▪ Gain22</li></ul>



## 7.6 Category: CounterAndTimerControl

This chapter lists all features that relates to control and monitoring of Counters and Timers.

### 7.6.1 CounterDuration

Sets the duration (or number of events) before the CounterEnd event is generated.

When the counter reaches the CounterDuration value, a CounterEnd event is generated, the CounterActive signal becomes inactive and the counter stops counting until a new trigger happens or it is explicitly reset with CounterReset.

<b>Name</b>	CounterDuration
<b>Category</b>	CounterAndTimerControl
<b>Interface</b>	Integer
<b>Access</b>	Read / Write
<b>Unit</b>	-
<b>Values</b>	0 ... 65535 (Increment: 1)

### 7.6.2 CounterEventActivation

Selects the Activation mode Event Source signal.

<b>Name</b>	CounterEventActivation	
<b>Category</b>	CounterAndTimerControl	
<b>Interface</b>	IEumeration	
<b>Access</b>	Read / Write	
<b>Unit</b>	-	
<b>Values</b>	RisingEdge	Counts on the Rising Edge of the signal.
	FallingEdge	Counts on the Falling Edge of the signal.
	AnyEdge	Counts on the Falling or rising Edge of the selected signal.

### 7.6.3 CounterEventSource

Select the events that will be the source to increment the Counter.

<b>Name</b>	CounterEventSource	
<b>Category</b>	CounterAndTimerControl	
<b>Interface</b>	IEumeration	
<b>Access</b>	Read / Write	
<b>Unit</b>	-	
<b>Values</b>	Counter1End	Counts the number of Counter1 End.
	Counter2End	Counts the number of Counter2 End.
	ExposureActive	Counts all Exposures.
	FrameTransferSkipped	Counts when a frame transfer skipped.
	Line0	Counts the number of signals on I/O Line0.
	Line1*	Counts the number of signals on I/O Line1.
	Line2*	Counts the number of signals on I/O Line2.
	Line3**	Counts the number of signals on I/O Line3.
	FrameTrigger	Counts the number of Frame Start Trigger.
	Off	Disable the Counter Reset trigger.
	TriggerSkipped	Counts when a Trigger skipped.

\*) ≥ Release 3

\*\*) only VCXG.I / .XT / .PTP

### 7.6.4 CounterReset

Does a software reset of the selected Counter and starts it. The counter starts counting events immediately after the reset unless a Counter trigger is active. CounterReset can be used to reset the Counter independently from the CounterResetSource. To disable the counter temporarily, set CounterEventSource to Off.

#### Notice

Note that the value of the Counter at time of reset is automatically latched and reflected in the *CounterValueAtReset*.

<b>Name</b>	CounterReset
<b>Category</b>	CounterAndTimerControl
<b>Interface</b>	ICommand
<b>Access</b>	Write only
<b>Unit</b>	-
<b>Values</b>	-

### 7.6.5 CounterResetActivation

Selects the Activation mode of the Counter Reset Source signal.

<b>Name</b>	CounterResetActivation	
<b>Category</b>	CounterAndTimerControl	
<b>Interface</b>	IEumeration	
<b>Access</b>	Read / Write	
<b>Unit</b>	-	
<b>Values</b>	RisingEdge	Resets the counter on the Rising Edge of the signal.
	FallingEdge	Resets the counter on the Falling Edge of the signal.
	AnyEdge	Resets the counter on the Falling or rising Edge of the selected signal.

### 7.6.6 CounterResetSource

Selects the signals that will be the source to reset the Counter.

<b>Name</b>	CounterResetSource	
<b>Category</b>	CounterAndTimerControl	
<b>Interface</b>	IEumeration	
<b>Access</b>	Read / Write	
<b>Unit</b>	-	
<b>Values</b>	Counter1End	Resets with the reception of the Counter End.
	Counter2End	Resets with the reception of the Counter End.
	Line0	Resets by the I/O Line0.
	Line1*	Resets by the I/O Line1.
	Line2*	Resets by the I/O Line2.
	Line3**/**	Resets by the I/O Line3.
	Off	Disable the Counter Reset trigger.

\*) ≥ Release 3

\*\*) only VCXG.I / .XT / .PTP

### 7.6.7 CounterSelector

Selects which Counter to configure.

<b>Name</b>	CounterSelector	
<b>Category</b>	CounterAndTimerControl	
<b>Interface</b>	IEumeration	
<b>Access</b>	Read / Write	
<b>Unit</b>	-	
<b>Values</b>	Counter1	Selects the counter 1.
	Counter2	Selects the counter 2.

### 7.6.8 CounterValue

Reads or writes the current value of the selected Counter. Writing to CounterValue is typically used to set the start value.

<b>Name</b>	CounterValue
<b>Category</b>	CounterAndTimerControl
<b>Interface</b>	Integer
<b>Access</b>	Read / Write
<b>Unit</b>	-
<b>Values</b>	0 ... 65535 (Increment: 1)

### 7.6.9 CounterValueAtReset

Reads the value of the selected Counter when it was reset by a trigger or by an explicit CounterReset command.

It represents the last counter value latched before resetting the counter.

<b>Name</b>	CounterValueAtReset
<b>Category</b>	CounterAndTimerControl
<b>Interface</b>	Integer
<b>Access</b>	Read only
<b>Unit</b>	-
<b>Values</b>	0 ... 65535 (Increment: 1)

### 7.6.10 FrameCounter

The FrameCounter is part of the Baumer Image Info Header (chunk) and is added to every image if chunk mode is activated. It is generated by the hardware and can be used to verify that each of the camera's images is transmitted to the PC and received in the right order.

It is possible to set the FrameCounter to a specific value by write this value to the FrameCounter.

<b>Name</b>	FrameCounter
<b>Category</b>	CounterAndTimerControl
<b>Interface</b>	Integer
<b>Access</b>	Read / Write
<b>Unit</b>	-
<b>Values</b>	0 ... 4294967295 (Increment: 1)

### 7.6.11 TimerDelay

Sets the duration (in microseconds) of the delay to apply at the reception of a trigger before starting the Timer.

<b>Name</b>	TimerDelay
<b>Category</b>	CounterAndTimer
<b>Interface</b>	IFloat
<b>Access</b>	Read / Write
<b>Unit</b>	µs
<b>Values</b>	0 ... 2,000,000.000000 (Increment: 1.00)

### 7.6.12 TimerDuration

Sets the duration (in microseconds) of the Timer pulse.

<b>Name</b>	TimerDuration
<b>Category</b>	CounterAndTimer
<b>Interface</b>	IFloat
<b>Access</b>	Read / Write
<b>Unit</b>	µs
<b>Values</b>	10.000000 ... 2,000,000.000000 (Increment: 1.00)

### 7.6.13 TimerSelector

Selects which Timer to configure.

<b>Name</b>	TimerSelector
<b>Category</b>	CounterAndTimerControl
<b>Interface</b>	IEumeration
<b>Access</b>	Read / Write
<b>Unit</b>	-
<b>Values</b>	Timer1      Selects the Timer 1.

### 7.6.14 TimerTriggerActivation

Selects the activation mode of the trigger to start the Timer.

<b>Name</b>	TimerTriggerActivation	
<b>Category</b>	CounterAndTimerControl	
<b>Interface</b>	IEumeration	
<b>Access</b>	Read / Write	
<b>Unit</b>	-	
<b>Values</b>	RisingEdge	Starts counting on the Rising Edge of the selected trigger signal.
	FallingEdge	Starts counting on the Falling Edge of the selected trigger signal.
	AnyEdge	Starts counting on the Falling or Rising Edge of the selected trigger signal.

### 7.6.15 TimerTriggerSource

Selects the source of the trigger to start the Timer.

<b>Name</b>	TimerTriggerSource	
<b>Category</b>	CounterAndTimerControl	
<b>Interface</b>	IEumeration	
<b>Access</b>	Read / Write	
<b>Unit</b>	-	
<b>Values</b>	Action1 (only GigE)	Starts with the assertion of the chosen action signal.
	ExposureEnd	Starts with the reception of the Exposure End.
	ExposureStart	Starts with the reception of the Exposure Start.
	FrameTransfer-Skipped	Frame Transfer Skipped.
	Line0	Starts when the specified TimerTriggerActivation condition is met on the chosen I/O Line.
	Line1	Starts when the specified TimerTriggerActivation condition is met on the chosen I/O Line.
	Off	Disables the Timer trigger.
	Software	Starts when the trigger was generated by the software.
	TriggerSkipped	Starts when a trigger was skipped.

## 7.7 Category: CustomDataControl (≥ Release 3 only)

The feature contains the category of the custom data related features.

### 7.7.1 CustomData

The feature holds one byte of custom special data.

<b>Name</b>	CustomData
<b>Category</b>	CustomDataControl
<b>Interface</b>	Integer
<b>Access</b>	Read / Write
<b>Unit</b>	-
<b>Values</b>	0x0 ... 0xFF (Increment: 1)

### 7.7.2 CustomDataSelector

The feature selects the index of the custom data byte array.

<b>Name</b>	CustomDataSelector
<b>Category</b>	CustomDataControl
<b>Interface</b>	Integer
<b>Access</b>	Read / Write
<b>Unit</b>	-
<b>Values</b>	0 ... 127 (Increment: 1)

## 7.8 Category: DeviceControl

Category for device information and control.

### 7.8.1 DeviceCharacterSet

Character set used by the strings of the device's bootstrap registers.

<b>Name</b>	DeviceCharacterSet	
<b>Category</b>	DeviceControl	
<b>Interface</b>	IEnumeration	
<b>Access</b>	Read only	
<b>Unit</b>	-	
<b>Values</b>	ASCII	Device use ASCII character set.
	UTF16	Device use UTF16 character set.
	UTF8	Device use UTF8 character set.

### 7.8.2 DeviceEventChannelCount

Indicates the number of event channels supported by the device.

<b>Name</b>	DeviceEventChannelCount	
<b>Category</b>	DeviceControl	
<b>Interface</b>	Integer	
<b>Access</b>	Read only	
<b>Unit</b>	-	
<b>Values</b>	0 ... 4294967295 (Increment: 1)	

### 7.8.3 DeviceFamilyName

Identifier of the product family of the device.

<b>Name</b>	DeviceFamilyName	
<b>Category</b>	DeviceControl	
<b>Interface</b>	IString	
<b>Access</b>	Read only	
<b>Unit</b>	-	
<b>Values</b>	device family name	



#### 7.8.4 DeviceFirmwareVersion

Version of the firmware in the device.

<b>Name</b>	DeviceFirmwareVersion
<b>Category</b>	DeviceControl
<b>Interface</b>	IString
<b>Access</b>	Read only
<b>Unit</b>	-
<b>Values</b>	e.g. CID:000057/PID:11194280

#### 7.8.5 DeviceGenCPVersionMajor

Major version of the GenCP protocol supported by the device.

<b>Name</b>	DeviceGenCPVersionMajor
<b>Category</b>	DeviceControl
<b>Interface</b>	Integer
<b>Access</b>	Read only
<b>Unit</b>	-
<b>Values</b>	0 ... 65535 (Increment: 1)

#### 7.8.6 DeviceGenCPVersionMinor

Minor version of the GenCP protocol supported by the device.

<b>Name</b>	DeviceGenCPVersionMinor
<b>Category</b>	DeviceControl
<b>Interface</b>	Integer
<b>Access</b>	Read only
<b>Unit</b>	-
<b>Values</b>	0 ... 65535 (Increment: 1)

#### 7.8.7 DeviceLinkCommandTimeout

Indicates the current command timeout of the specific Link.

<b>Name</b>	DeviceLinkCommandTimeout
<b>Category</b>	DeviceControl
<b>Interface</b>	IFloat
<b>Access</b>	Read only
<b>Unit</b>	µs
<b>Values</b>	200,000.000000 (Increment: 1)

### 7.8.8 DeviceLinkHeartbeatMode

Activate or deactivate the Link's heartbeat.

<b>Name</b>	DeviceLinkHeartbeatMode	
<b>Category</b>	DeviceControl	
<b>Interface</b>	IEnumeration	
<b>Access</b>	Read / Write	
<b>Unit</b>	-	
<b>Values</b>	On	Enables the Link heartbeat.
	Off	Disables the Link heartbeat.

### 7.8.9 DeviceLinkHeartbeatTimeout

Controls the current heartbeat timeout of the specific Link.

If this time is exceeded without a read access, the camera disconnects itself to be ready for the next connection of another application, or reconnection of the restarted PC application.

The exceedance can be caused, for example, by a crashed software or a CPU overload of the PC.

<b>Name</b>	DeviceLinkHeartbeatTimeout	
<b>Category</b>	DeviceControl	
<b>Interface</b>	IFloat	
<b>Access</b>	Read / Write	
<b>Unit</b>	µs	
<b>Values</b>	500,000.000000 ... 4,294,967,295,000.000000 (Increment: 1)	

### 7.8.10 DeviceLinkSelector

Selects which Link of the device to control.

Generally, a device has only one Link that can be composed of one or many connections. But if there are many, this selector can be used to target a particular Link of the device with certain features.

<b>Name</b>	DeviceLinkSelector	
<b>Category</b>	DeviceControl	
<b>Interface</b>	IInteger	
<b>Access</b>	Read / Write	
<b>Unit</b>	-	
<b>Values</b>	0 ... 0 (Increment: 1)	

### 7.8.11 DeviceLinkSpeed

Indicates the speed of transmission negotiated on the specified link.

<b>Name</b>	DeviceLinkSpeed
<b>Category</b>	DeviceControl
<b>Interface</b>	Integer
<b>Access</b>	Read only
<b>Unit</b>	Bps
<b>Values</b>	0 ... 9223372036854775807 (Increment: 1)

### 7.8.12 DeviceLinkThroughputLimit

Limits the maximum bandwidth of the data that will be streamed out by the device on the selected Link. If necessary, delays will be uniformly inserted between transport layer packets in order to control the peak bandwidth.

<b>Name</b>	DeviceLinkThroughputLimit
<b>Category</b>	DeviceControl
<b>Interface</b>	Integer
<b>Access</b>	Read / Write
<b>Unit</b>	Bps
<b>Values</b>	GigE: 1250000 ... 125000000 (Increment: 1250000) USB: 1000000 ... 400000000 (Increment: 1000000)

### 7.8.13 DeviceManufacturerInfo

Manufacturer information about the device.

The content might look as follows:

Firmware (F) / FPGA (C) / BL3-Version (BL)

<b>Name</b>	DeviceManufacturerInfo
<b>Category</b>	DeviceControl
<b>Interface</b>	IString
<b>Access</b>	Read only
<b>Unit</b>	-
<b>Values</b>	e. g. F:00007F9A/C:0180802D/BL3.8:00000081

### 7.8.14 DeviceModelName

Model of the device.

<b>Name</b>	DeviceModelName
<b>Category</b>	DeviceControl
<b>Interface</b>	IString
<b>Access</b>	Read only
<b>Unit</b>	-
<b>Values</b>	model name of the camera

### 7.8.15 DeviceRegistersEndiannes

Endianess of the register of the device.

<b>Name</b>	DeviceRegistersEndianness
<b>Category</b>	DeviceControl
<b>Interface</b>	IEnumeration
<b>Access</b>	Read only
<b>Unit</b>	-
<b>Values</b>	Big            Device registers are big Endian. Little        Device registers are little Endian

### 7.8.16 DeviceReset

The Device Reset feature corresponds with the camera's switched on and switched off states. Using this means it is no longer necessary to disconnect the power supply.

#### Notice

The execution of this feature may take several seconds.

<b>Name</b>	DeviceReset
<b>Category</b>	DeviceControl
<b>Interface</b>	ICommand
<b>Access</b>	Write only
<b>Unit</b>	-
<b>Values</b>	-

### 7.8.17 DeviceResetToDeliveryState

By executing this feature, the camera is set to the factory settings. The settings stored in the camera (e.g. *UserSets*) will be lost.

<b>Name</b>	DeviceResetToDeliveryState
<b>Category</b>	DeviceControl
<b>Interface</b>	ICommand
<b>Access</b>	Write only
<b>Unit</b>	-
<b>Values</b>	-

### 7.8.18 DeviceSFNCVersionMajor

Major version of the Standard Features Naming Convention that was used to create the device's GenICam XML.

<b>Name</b>	DeviceSFNCVersionMajor
<b>Category</b>	DeviceControl
<b>Interface</b>	IInteger
<b>Access</b>	Read only
<b>Unit</b>	-
<b>Values</b>	>0

### 7.8.19 DeviceSFNCVersionMinor

Minor version of the Standard Features Naming Convention that was used to create the device's GenICam XML.

<b>Name</b>	DeviceSFNCVersionMinor
<b>Category</b>	DeviceControl
<b>Interface</b>	IInteger
<b>Access</b>	Read only
<b>Unit</b>	-
<b>Values</b>	>0

### 7.8.20 DeviceSFNCVersionSubMinor

Sub minor version of the Standard Features Naming Convention that was used to create the device's GenICam XML.

<b>Name</b>	DeviceSFNCVersionSubMinor
<b>Category</b>	DeviceControl
<b>Interface</b>	IInteger
<b>Access</b>	Read only
<b>Unit</b>	-
<b>Values</b>	>0

### 7.8.21 DeviceScanType

Scan type of the sensor of the device.

<b>Name</b>	DeviceScanType
<b>Category</b>	DeviceControl
<b>Interface</b>	IEnumeration
<b>Access</b>	Read only
<b>Unit</b>	-
<b>Values</b>	Areascan    2D Sensor.

### 7.8.22 DeviceSensorType

This feature specifies the type of the sensor.

<b>Name</b>	DeviceSensorType
<b>Category</b>	DeviceControl
<b>Interface</b>	IEnumeration
<b>Access</b>	Read only
<b>Unit</b>	-
<b>Values</b>	CCD            CCD sensor. CMOS           CMOS sensor.

### 7.8.23 DeviceSerialNumber

Device's serial number. This string is a unique identifier of the device.

<b>Name</b>	DeviceSerialNumber
<b>Category</b>	DeviceControl
<b>Interface</b>	IString
<b>Access</b>	Read only
<b>Unit</b>	-
<b>Values</b>	e.g. 1117281217

### 7.8.24 DeviceStreamChannelCount

Indicates the number of streaming channels supported by the device.

<b>Name</b>	DeviceStreamChannelCount
<b>Category</b>	DeviceControl
<b>Interface</b>	Integer
<b>Access</b>	Read only
<b>Unit</b>	-
<b>Values</b>	0 ... 4294967295 (Increment: 1)

### 7.8.25 DeviceStreamChannelEndianness

Endianness of multi-byte pixel data for this stream.

<b>Name</b>	DeviceStreamChannelEndianness	
<b>Category</b>	DeviceControl	
<b>Interface</b>	Enumeration	
<b>Access</b>	Read / Write	
<b>Unit</b>	-	
<b>Values</b>	Big	Endianness of multi-byte pixel data for this stream is big Endian.
	Little	Endianness of multi-byte pixel data for this stream is little Endian.

### 7.8.26 DeviceStreamChannelPacketSize

Specifies the stream packet size, in bytes, to send on the selected channel for a Transmitter or specifies the maximum packet size supported by a receiver.

<b>Name</b>	DeviceStreamChannelPacketSize
<b>Category</b>	DeviceControl
<b>Interface</b>	Integer
<b>Access</b>	Read only
<b>Unit</b>	Byte
<b>Values</b>	576 ... 9000 (Increment: 2)

### 7.8.27 DeviceStreamChannelSelector

Selects the stream channel to control.

<b>Name</b>	DeviceStreamChannelSelector
<b>Category</b>	DeviceControl
<b>Interface</b>	Integer
<b>Access</b>	Read / Write
<b>Unit</b>	-
<b>Values</b>	0 ... 0 (Increment: 1)

### 7.8.28 DeviceStreamChannelType

Reports the type of the stream channel.

<b>Name</b>	DeviceStreamChannelType	
<b>Category</b>	DeviceControl	
<b>Interface</b>	IEnumeration	
<b>Access</b>	Read only	
<b>Unit</b>	-	
<b>Values</b>	Receiver	Data stream receiver channel.
	Transmitter	Data stream transmitter channel.

### 7.8.29 DeviceTLType

Transport Type of the device.

<b>Name</b>	DeviceTLType	
<b>Category</b>	DeviceControl	
<b>Interface</b>	IEnumeration	
<b>Access</b>	Read only	
<b>Unit</b>	-	
<b>Values</b>	GigEVision	
	USB3Vision	

### 7.8.30 DeviceTLVersionMajor

Major version of the Transport Layer (GigE Vision® version) of the device.

<b>Name</b>	DeviceTLVersionMajor	
<b>Category</b>	DeviceControl	
<b>Interface</b>	IInteger	
<b>Access</b>	Read only	
<b>Unit</b>	-	
<b>Values</b>	0 ... 65535 (Increment: 1)	

### 7.8.31 DeviceTLVersionMinor

Minor version of the Transport Layer (GigE Vision® version) of the device.

<b>Name</b>	DeviceTLVersionMinor	
<b>Category</b>	DeviceControl	
<b>Interface</b>	IInteger	
<b>Access</b>	Read only	
<b>Unit</b>	-	
<b>Values</b>	0 ... 65535 (Increment: 1)	



### 7.8.32 DeviceTLVersionSubMinor

Minor version of the Transport Layer (GigE Vision® version) of the device.

<b>Name</b>	DeviceTLVersionSubMinor
<b>Category</b>	DeviceControl
<b>Interface</b>	IInteger
<b>Access</b>	Read only
<b>Unit</b>	-
<b>Values</b>	0 ... 9223372036854775807 (Increment: 1)

### 7.8.33 DeviceTemperature

Device temperature in degrees Celsius (C). It is measured at the location selected by *DeviceTemperatureSelector*.

<b>Name</b>	DeviceTemperature
<b>Category</b>	DeviceControl
<b>Interface</b>	IFloat
<b>Access</b>	Read only
<b>Unit</b>	° C
<b>Values</b>	-127.0 ... 127.0

### 7.8.34 DeviceTemperatureExceeded

Returns if the device operates in critical temperature range.

<b>Name</b>	DeviceTemperatureExceeded
<b>Category</b>	DeviceControl
<b>Interface</b>	IBoolean
<b>Access</b>	Read only
<b>Unit</b>	-
<b>Values</b>	true = 1 (On) false = 0 (Off)

### 7.8.35 DeviceTemperatureSelector

Selects the location within the device, where the temperature will be measured.

<b>Name</b>	DeviceTemperatureSelector
<b>Category</b>	DeviceControl
<b>Interface</b>	IEnumeration
<b>Access</b>	Read / Write
<b>Unit</b>	-
<b>Values</b>	InHouse      Temperature inside the camera housing.

### 7.8.36 DeviceTemperatureStatus

Returns the current temperature status of the device.

<b>Name</b>	DeviceTemperatureStatus	
<b>Category</b>	DeviceControl	
<b>Interface</b>	IEnumeration	
<b>Access</b>	Read only	
<b>Unit</b>	-	
<b>Values</b>	Exceeded	Device operates in critical temperature range.
	High	Device operates in increased temperature range.
	Normal	Device operates in normal temperature range.

### 7.8.37 DeviceTemperatureStatusTransition

Temperature threshold for selected status transition in degrees Celsius (C).

<b>Name</b>	DeviceTemperatureStatusTransition
<b>Category</b>	DeviceControl
<b>Interface</b>	IInteger
<b>Access</b>	Read / Write
<b>Unit</b>	° C
<b>Values</b>	-126.0 ... 72.0

### 7.8.38 DeviceTemperatureStatusTransitionSelector (≥ Rel. 2 only)

Selects which temperature transition is controlled by the DeviceTemperatureStatusTransition feature.

<b>Name</b>	DeviceTemperatureStatusTransitionSelector	
<b>Category</b>	DeviceControl	
<b>Interface</b>	IEnumeration	
<b>Access</b>	Read / Write	
<b>Unit</b>	-	
<b>Values</b>	ExceededToNormal	Temperature threshold for transition from status Exceeded back to status Normal.
	HighToExceeded	Temperature threshold for transition from status High to status Exceeded.
	NormalToHigh	Temperature threshold for transition from status Normal to status High.

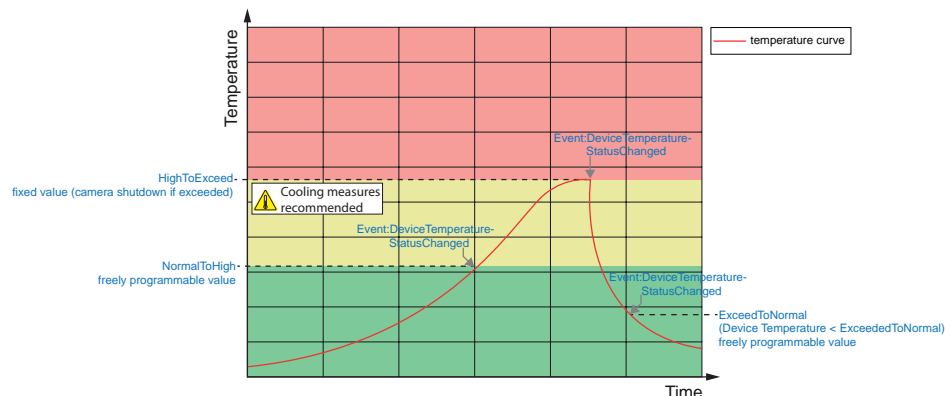

### 7.8.39 DeviceType

Returns the device type.

<b>Name</b>	DeviceType
<b>Category</b>	DeviceControl
<b>Interface</b>	IEnumeration
<b>Access</b>	Read only
<b>Unit</b>	-
<b>Values</b>	Transmitter      Data stream transmitter device.

### 7.8.40 DeviceUserID

User-programmable device identifier.

<b>Name</b>	DeviceUserID
<b>Category</b>	DeviceControl
<b>Interface</b>	IString
<b>Access</b>	Read / Write
<b>Unit</b>	-
<b>Values</b>	e.g. "camera 1" (max. length 64)

### 7.8.41 DeviceVendorName

Name of the manufacturer of the device.

<b>Name</b>	DeviceVendorName
<b>Category</b>	DeviceControl
<b>Interface</b>	IString
<b>Access</b>	Read only
<b>Unit</b>	-
<b>Values</b>	Name of the camera manufacturer

### 7.8.42 DeviceVersion

Version of the device.

<b>Name</b>	DeviceVersion
<b>Category</b>	DeviceControl
<b>Interface</b>	IString
<b>Access</b>	Read only
<b>Unit</b>	-
<b>Values</b>	e.g. R1.0.0

### 7.8.43 ReadOutTime

Readout time in  $\mu\text{s}$  for current format settings.

#### Notice

Read Out Time depends on:

- OffsetY
- Height
- PixelFormat
- SensorBinning

<b>Name</b>	ReadOutTime
<b>Category</b>	DeviceControl
<b>Interface</b>	Integer
<b>Access</b>	Read only
<b>Unit</b>	$\mu\text{s}$
<b>Values</b>	0 ... 65535 (Increment: 1)

### 7.8.44 TimestampLatch

Latches the current timestamp counter into *TimestampLatchValue*.

<b>Name</b>	TimestampLatch
<b>Category</b>	DeviceControl
<b>Interface</b>	ICommand
<b>Access</b>	Write only
<b>Unit</b>	-
<b>Values</b>	-

### 7.8.45 TimestampLatchValue

Returns the latched value of the timestamp counter.

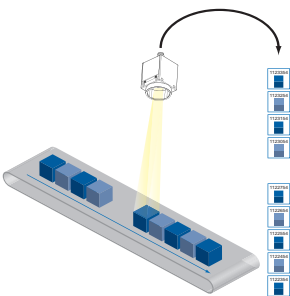

<b>Name</b>	TimestampLatchValue
<b>Category</b>	DeviceControl
<b>Interface</b>	Integer
<b>Access</b>	Read only
<b>Unit</b>	ns
<b>Values</b>	$\geq 0$ (Increment: 8 (GigE) / 10 (USB))

### 7.8.46 TimestampLatchValuePtpDays

The feature returns the latched value of the Ptp timestamp in days since 01.01.1970 00:00:00.

<b>Name</b>	TimestampLatchValuePtpDays
<b>Category</b>	DeviceControl
<b>Interface</b>	IInteger
<b>Access</b>	Read only
<b>Unit</b>	-
<b>Values</b>	0 ... 9223372036854775807 (Increment: 1)

### 7.8.47 TimestampReset

Resets the current value of the device timestamp counter.

<b>Name</b>	TimestampReset
<b>Category</b>	DeviceControl
<b>Interface</b>	ICommand
<b>Access</b>	Write only
<b>Unit</b>	-
<b>Values</b>	-

## 7.8.48 USB2SupportEnable

Enable or disable the streaming support for USB 2.0.



### Caution

If the camera is connected to an USB 2.0 port image transmission is disabled by default. The camera consumes more than 2.5W which is the maximum allowed by the USB 2.0 specification. But there is a possibility to activate the image transmission at your own risk!

This activation could damage your computer's hardware!



### Procedure

1. Open the camera in the *Camera Explorer*.
2. Select the Profile *GenICam Guru*.
3. Activate the Feature *USB2 Support Enable* in the category *Device Control*.
4. Disconnect the data connection of the camera to the USB 2.0 port.
5. Connect the data connection of the camera to the USB 2.0 port.
6. Images will be transmitted via the USB 2.0 port.

<b>Name</b>	USB2SupportEnable
<b>Category</b>	DeviceControl
<b>Interface</b>	IBoolean
<b>Access</b>	Read / Write
<b>Unit</b>	-
<b>Values</b>	true = 1 (On) false = 0 (Off)

## 7.9 Category: DigitalIOControl

The Digital I/O chapter covers the features required to control the general Input and Output signals of the device.

### Trigger

Trigger signals are used to synchronize the camera exposure and a machine cycle or, in case of a software trigger, to take images at predefined time intervals.

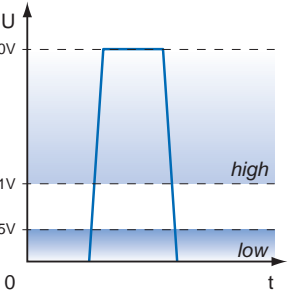
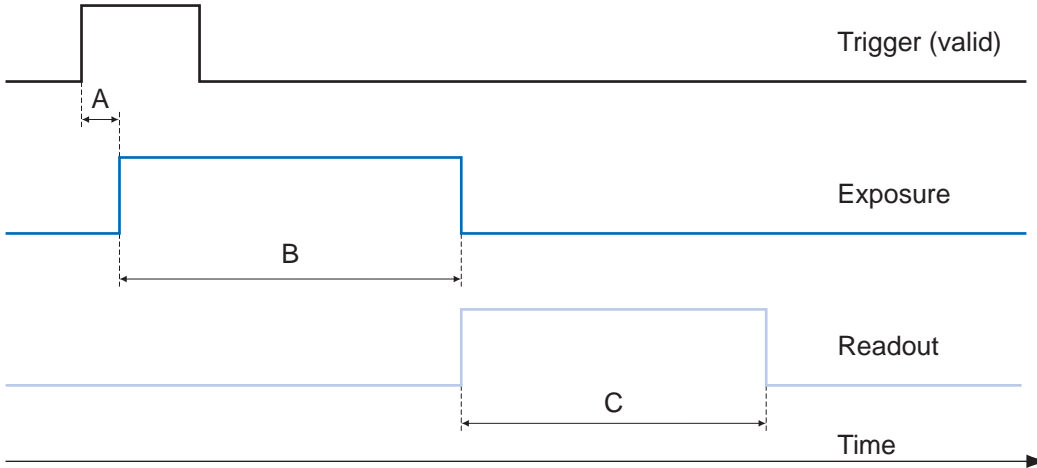

- A - Trigger delay
- B - Exposure time
- C - Readout time

Different trigger sources can be used here.

### Trigger Source (Examples of possible trigger sources)

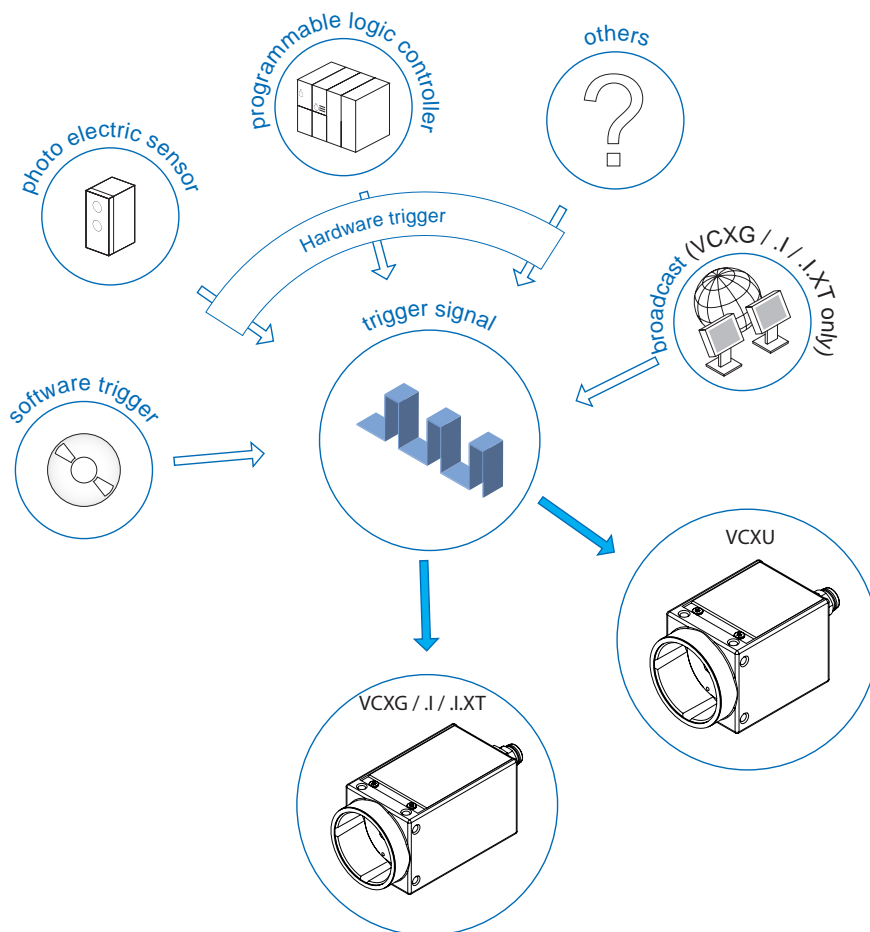

**Trigger Delay:**

The trigger delay is a flexible user-defined delay between the given trigger impulse and the image capture. The delay time can be set between 0.0  $\mu$ s and 2.0 s in increments of 1  $\mu$ s. Where there are multiple triggers during the delay, the triggers will also be stored and delayed. The buffer is able to store up to 512 trigger signals during the delay.

Your benefits:

- No need for an external trigger sensor to be perfectly aligned
- Different objects can be captured without hardware changes

Each trigger source must be activated separately. When the trigger mode is activated, the hardware trigger is activated by default.

## Debouncer (LineDebouncerHighTimeAbs / LineDebouncerLowTimeAbs)

The basic idea behind this feature was to separate interfering signals (short peaks) from valid square wave signals, which can be important in industrial environments. Debouncing means that invalid signals are filtered out, and signals lasting longer than a user-defined testing time  $t_{\text{DebounceHigh}}$  will be recognized and routed to the camera to induce a trigger.

In order to detect the end of a valid signal and filter out possible jitters within the signal, a second testing time  $t_{\text{DebounceLow}}$  was introduced. The timing for this can also be adjusted by the user. If the signal value falls to state low and does not rise within  $t_{\text{DebounceLow}}$ , this is recognized as the end of the signal.

The debouncing times  $t_{\text{DebounceHigh}}$  and  $t_{\text{DebounceLow}}$  are adjustable from 0 to 5 ms in increments of 1  $\mu\text{s}$ .

### Notice

Please note that the edges of valid trigger signals are shifted by  $t_{\text{DebounceHigh}}$  and  $t_{\text{DebounceLow}}$ !

Depending on these two timings, the trigger signal may be temporally stretched or compressed.

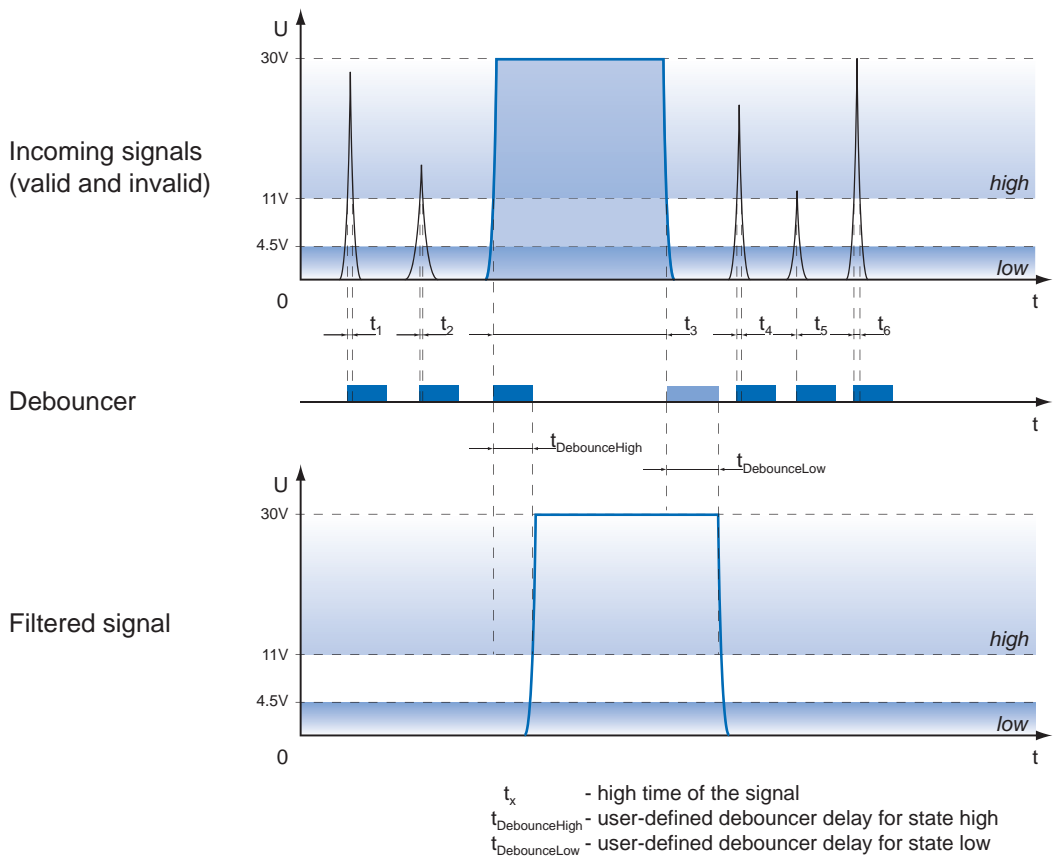



### 7.9.1 LineDebouncerHighTimeAbs

Sets the absolute value of the selected line debouncer time in microseconds for switch from low to high.

<b>Name</b>	LineDebouncerHighTimeAbs
<b>Category</b>	DigitalIOControl
<b>Interface</b>	IFloat
<b>Access</b>	Read / Write
<b>Unit</b>	µs
<b>Values</b>	0.000000 - 5,000.000000 (Increment: 1.00)

### 7.9.2 LineDebouncerLowTimeAbs

Sets the absolute value of the selected line debouncer time in microseconds for switch from high to low.

<b>Name</b>	LineDebouncerLowTimeAbs
<b>Category</b>	DigitalIOControl
<b>Interface</b>	IFloat
<b>Access</b>	Read / Write
<b>Unit</b>	µs
<b>Values</b>	0.000000 - 5,000.000000 (Increment: 1.00)

### 7.9.3 LineFormat (only VCXG.I / .XT / .PTP)

Controls the current electrical format of the selected physical input or output Line.

By switching the LineFormat, the behavior of the outputs can be adapted to the respective installation.

#### Notice

In all modes the supply voltage for the outputs (Pin 11, 12) must be connected!

<b>Name</b>	LineFormat
<b>Category</b>	DigitalIOControl
<b>Interface</b>	IEnumeration
<b>Access</b>	Read / Write
<b>Unit</b>	-
<b>Values</b>	see table below

The following line formats are available for each of the 4 outputs:

Modes	Description	Circuit
<b>Push-Pull</b>	<p>This mode is used to generate sharp edges for fast switching processes.</p> <p><u>Advantage:</u> Sharp edges in both directions.</p> <p><u>Disadvantage:</u> For long cable more susceptible to ground bounce and potential differences.</p>	
<b>Open-Source</b>	<p>Typical applications for this mode are: PLC input, control of illumination connected to ground.</p> <p><u>Advantage:</u> Stable at long cable lengths and potential differences.</p> <p><u>Disadvantage:</u> The falling edge has a lower slope due to parasitic capacitances. Switching off is slower due to this lower slope.</p>	
<b>Open-Drain</b>	<p>A typical case of application for this mode is a illumination control connected to plus.</p> <p><u>Advantage:</u> Stable at long cable lengths and potential differences.</p> <p><u>Disadvantage:</u> The rising edge has a lower slope due to parasitic capacitances. Switching off is slower due to this lower slope.</p>	
<b>Tri-State</b>	<p>In this mode, the output is disabled.</p>	

### 7.9.4 LineInverter

Controls the inversion of the signal of the selected input or output Line.

<b>Name</b>	LineInverter
<b>Category</b>	DigitalIOControl
<b>Interface</b>	IBoolean
<b>Access</b>	Read / Write
<b>Unit</b>	-
<b>Values</b>	true = 1 (On) false = 0 (Off)

### 7.9.5 LineMode

Controls if the physical Line is used to Input or Output a signal.

<b>Name</b>	LineMode
<b>Category</b>	DigitalIOControl
<b>Interface</b>	IEnumeration
<b>Access</b>	Read only
<b>Unit</b>	-
<b>Values</b>	Input    The selected physical line is used to Input an electrical signal. Output    The selected physical line is used to Output an electrical signal.

### 7.9.6 LinePWMConfigurationMode (only VCXG.I / .XT / .PTP)

Activates the Features *LinePWMMaxDuration* and *LinePWMMaxDutyCycle*.

<b>Name</b>	LinePWMConfigurationMode	
<b>Category</b>	DigitalIOControl	
<b>Interface</b>	IEnumeration	
<b>Access</b>	Read / Write	
<b>Unit</b>	-	
<b>Values</b>	Off	Disables the line PWM configuration mode.
	On	Enables the line PWM configuration mode.

With the function *Pulse Width Modulated Outputs (PWM)* it is possible to control an illumination controller or an illumination directly connected to the camera in various ways. The set *LineSource* is used as a signal for the control.

#### Caution

Erroneous settings can destroy the illumination! The outputs of the camera are protected against destruction. Please follow the information in the data sheets for your illumination. Contact the manufacturer of the illumination if you are unsure about admissible parameters.

##### Setting a output to a specific illumination

1. Set *LinePWMConfigurationMode* to *true*
2.  Set at *LinePWMMaxDutyCycle* and *LinePWMMaxDuration* the maximum admissible parameters of your illumination (e.g. Falcon FLDR-i90B-IR24).

*LinePWMMaxDutyCycle* = 10 %

*LinePWMMaxDuration* = 10 ms

3. Set *LinePWMConfigurationMode* to *false*.

→ The values set in step 2 are now the max. admissible parameters.

## Electrical specifications (Output Line4 ... Line7)



### Danger!

#### Use in wet environments requiring IP67 protection

Risk of electric shock. Electric shock can be fatal or cause serious injury.

Use is only permitted under consideration of pollution degree 2 and overvoltage category 2.

The M12 connectors must comply with the IEC 61076-2-101 standard.

The dielectric strength and withstand voltage for the plug/socket combination must be checked according to DIN EN 60664-1:2008-01 for 60 V.



## Electrical specifications (Output Line4 ... Line7)

$U_{EXT}$ :	12 V - 20 % ... 48 V + 10 % DC
$I_{OUT}$ :	- max. 1.5 A permanently in sum or per output individually
	- Pulse 40 % of the period, max. 2.5 A ( $t_{ON}$ max 1 s)
	- $t_{ON} = < 0.2 \mu s$ / $t_{OFF} = < 0.2 \mu s$
	- max. Frequency: 500 kHz

### Notice

In case of overload or short circuit, the outputs are disabled. To re-enable the output, disconnect Power (IO) (pin 12) from the power supply or perform a *DeviceReset*.

## 7.9.7 LinePWMDuration (only VCXG.I / .XT / .PTP)

Sets the pulse time in  $\mu s$ , with which the illumination is pulsed.

<b>Name</b>	LinePWMDuration
<b>Category</b>	DigitalIOControl
<b>Interface</b>	Integer
<b>Access</b>	Read / Write
<b>Unit</b>	$\mu s$
<b>Values</b>	1 - 5000 (Increment: 1)

## 7.9.8 LinePWMDutyCycle (only VCXG.I / .XT / .PTP)

Sets the duty cycle (ratio of pulse duration to period time duration) in %. This value is specified by the connected illumination.

<b>Name</b>	LinePWMDutyCycle
<b>Category</b>	DigitalIOControl
<b>Interface</b>	Integer
<b>Access</b>	Read / Write
<b>Unit</b>	%
<b>Values</b>	1 - 100 (Increment: 1)

### 7.9.9 LinePWMMaxDuration (only VCXG.I / .XT / .PTP)

Sets the maximum possible *LinePWMDuration* time in  $\mu$ s. This value is specified by the connected lighting.

<b>Name</b>	LinePWMMaxDuration
<b>Category</b>	DigitalIOControl
<b>Interface</b>	Integer
<b>Access</b>	Read / Write
<b>Unit</b>	$\mu$ s
<b>Values</b>	1 - 50000 (Increment: 1)

### 7.9.10 LinePWMMaxDutyCycle (only VCXG.I / .XT / .PTP)

Sets the maximum possible *LinePWMDutyCycle* in %. This value is specified by the connected illumination.

<b>Name</b>	LinePWMMaxDutyCycle
<b>Category</b>	DigitalIOControl
<b>Interface</b>	Integer
<b>Access</b>	Read / Write
<b>Unit</b>	%
<b>Values</b>	1 - 100 (Increment: 1)

### 7.9.11 LinePWMMode (only VCXG.I / .XT / .PTP)

Selects the PWM mode of the selected output line.

<b>Name</b>	LinePWMMode	
<b>Category</b>	DigitalIOControl	
<b>Interface</b>	IEnumeration	
<b>Access</b>	Read / Write	
<b>Unit</b>	-	
<b>Values</b>	Fixed Frequency	The selected output line generate a fixed frequency of pulses starting with every transition from 0 to 1 and stopping with every transition from 1 to 0.
	Off	The PWM Mode is off. The output line acts as a normal output.
	OnePulse	The selected output line generate one pulse with every transition from 0 to 1.

Timing diagrams of the PWMModes:

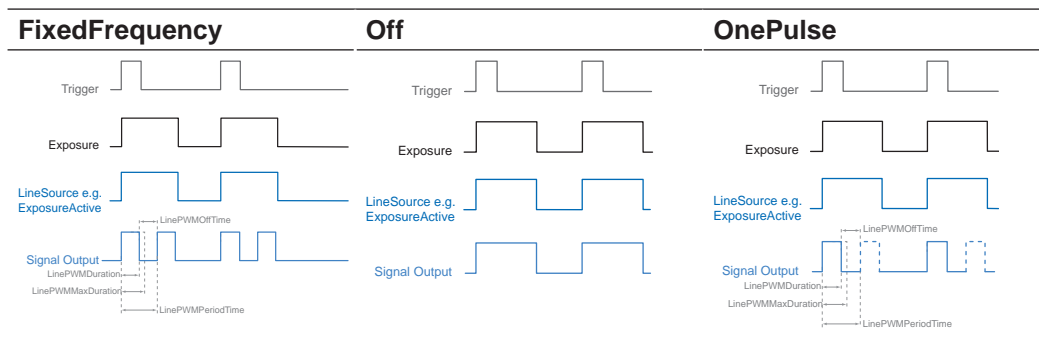

### 7.9.12 LinePWMOffTime (only VCXG.I / .XT / .PTP)

Offers the off time included in the PWM Period in microseconds.

<b>Name</b>	LinePWMMaxDutyCycle
<b>Category</b>	DigitalIOControl
<b>Interface</b>	Integer
<b>Access</b>	Read only
<b>Unit</b>	$\mu$ s
<b>Values</b>	-9223372036854775808 - 9223372036854775808 (Increment: 1)

### 7.9.13 LinePWMPeriodTime (only VCXG.I / .XT / .PTP)

Readout of the entire period in  $\mu$ s.

<b>Name</b>	LinePWMPeriodTime
<b>Category</b>	DigitalIOControl
<b>Interface</b>	Integer
<b>Access</b>	Read only
<b>Unit</b>	$\mu$ s
<b>Values</b>	depends on PWM settings

### 7.9.14 LineSelector

Selects the physical line (or pin) of the external device connector to configure.

<b>Name</b>	LineSelector
<b>Category</b>	DigitalIOControl
<b>Interface</b>	IEnumeration
<b>Access</b>	Read / Write
<b>Unit</b>	-
<b>Values</b>	see table below

	VCXG	VCXG.I/.I.XT/.PTP	VCXU
Line0	■	■	■
Line1	■ (GPIO)	■	■ (GPIO)
Line2	■ (GPIO)	■	■ (GPIO)
Line3	■	■	■
Line4	□	■	□
Line5	□	■	□
Line6	□	■	□
Line7	□	■	□



### 7.9.14.1 General Purpose Input/Output - GPIO (except VCXG.I/I.XT/PTP)

Lines 1 and 2 are GPIOs and can be inputs and outputs.

Used as an input: (0 ... 0.8 V low, 2.0 ... 3.0 V high).

Used as an output: (0 ... 0.4 V low, 2.4 ... 3.3 V high),  
@ 1 mA load (high) / 50 mA sink (low)

**⚠ Caution**

The General Purpose IOs (GPIOs) are not potential-free and do not have an overrun cut-off. Incorrect wiring (overvoltage, undervoltage or voltage reversal) can lead to defects within the electronics system.



GPIO Power  $V_{CC}$ : 3.3 V DC

Load resistor for TTL-High-Level: approx. 2.7 k $\Omega$

The GPIOs are configured as an input through the default camera settings. They must be connected to GPIO\_GND if not used or not configured as an output. The configuration as output by default (stored in a user set) is possible with cameras  $\geq$  Release 3.

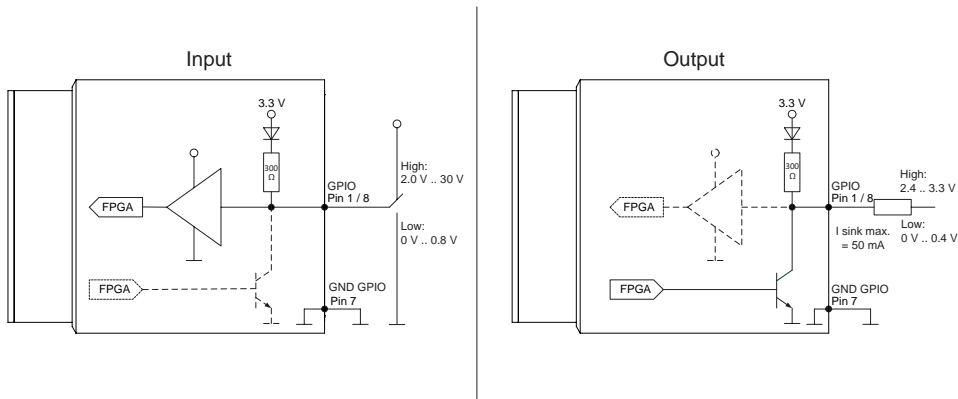

## 7.9.15 LineSource

With this feature, Baumer gives you the option to wire the output connectors to internal signals that are controlled on the software side.

On CX cameras, the output connector can be wired to one of the provided internal signals:

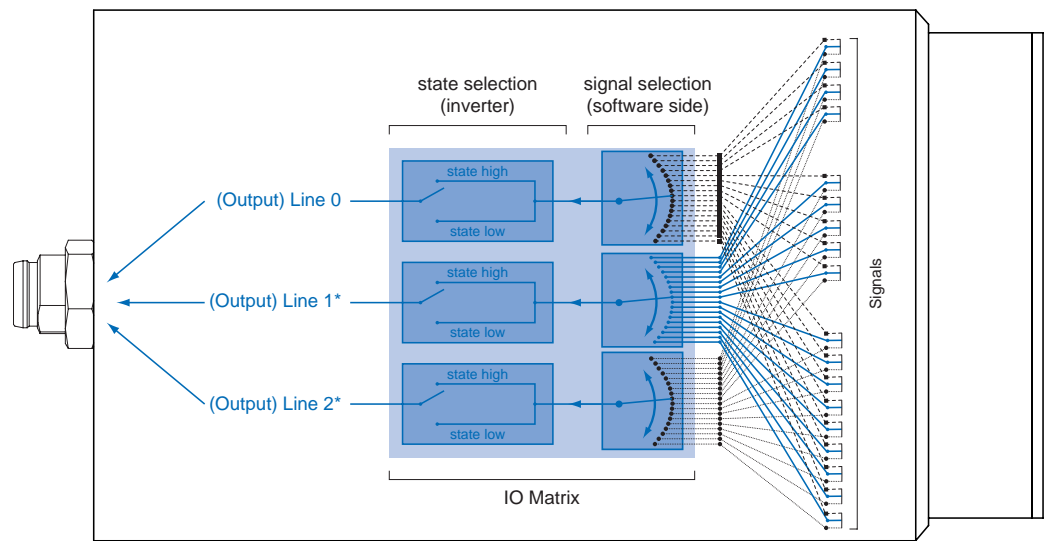

\* Example, if the two GPIO's are used as outputs. (only VCXG / VCXU)

\* VCXG.I / VCXG.I.XT is equipped with four fixed Outputs (Line0 ... Line3)

<b>Name</b>	LineSource
<b>Category</b>	DigitalIOControl
<b>Interface</b>	IEnumeration
<b>Access</b>	Read / Write
<b>Unit</b>	-
<b>Values</b>	see table below

Signals	
ExposureActive	Device is doing the exposure of a Frame (or Line).
Off	Line output is disabled (Tri-State).
Line 0	Device is currently waiting for signal of input line 0.
Line 1	Device is currently waiting for signal of input line 1.
ReadoutActive	Device is doing the readout of a Frame.
Timer1Active	The chosen Timer is in active state.
TriggerReady	Device is ready for trigger.
UserOutput1	The chosen User Output Bit state as defined by its current UserOutputValue.
UserOutput2 (only ≥ Rel. 2)	The chosen User Output Bit state as defined by its current UserOutputValue.
UserOutput3 (only ≥ Rel. 2)	The chosen User Output Bit state as defined by its current UserOutputValue.
UserOutput4 (only VCXG.I /.XT/ .PTP)	The chosen User Output Bit state as defined by its current UserOutputValue.

## ExposureActive

This signal is managed by exposure of the sensor.

Furthermore, the falling edge of the ExposureActive signal can be used to trigger a movement of the inspected objects. Due to this fact, the span time used for the sensor readout  $t_{\text{readout}}$  can be used optimally in industrial environments.

Depending on Sensor Shutter Mode (only cameras with Rolling Shutter sensors), the ExposureActive signal is active at different times.

### Sensor Shutter Mode: Global Reset

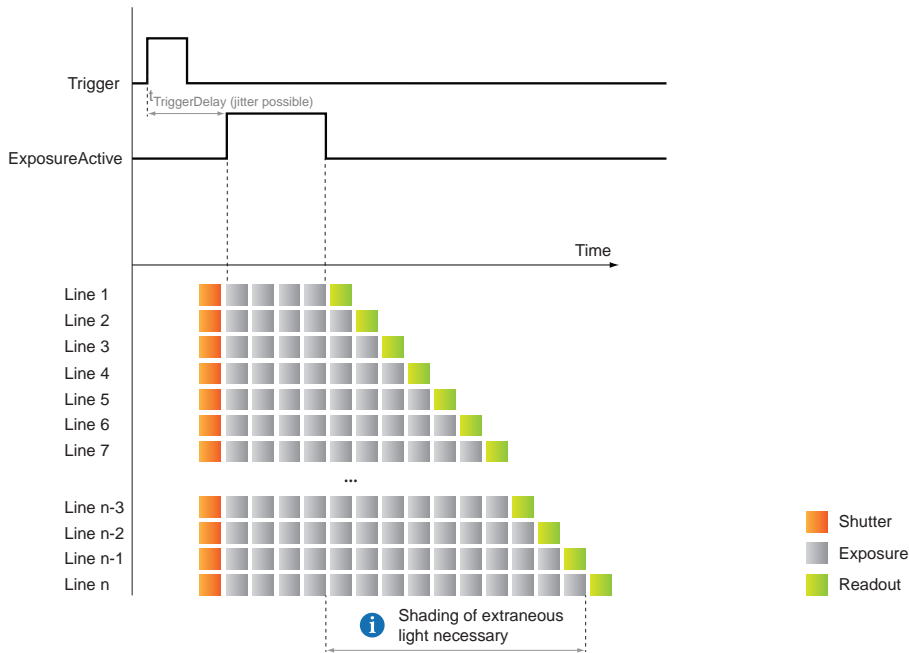

**Notice**  
 In Sensor Shutter Mode: Global Reset  $t_{\text{TriggerDelay}}$  is constant and independent of image settings.

### Sensor Shutter Mode: Rolling Shutter

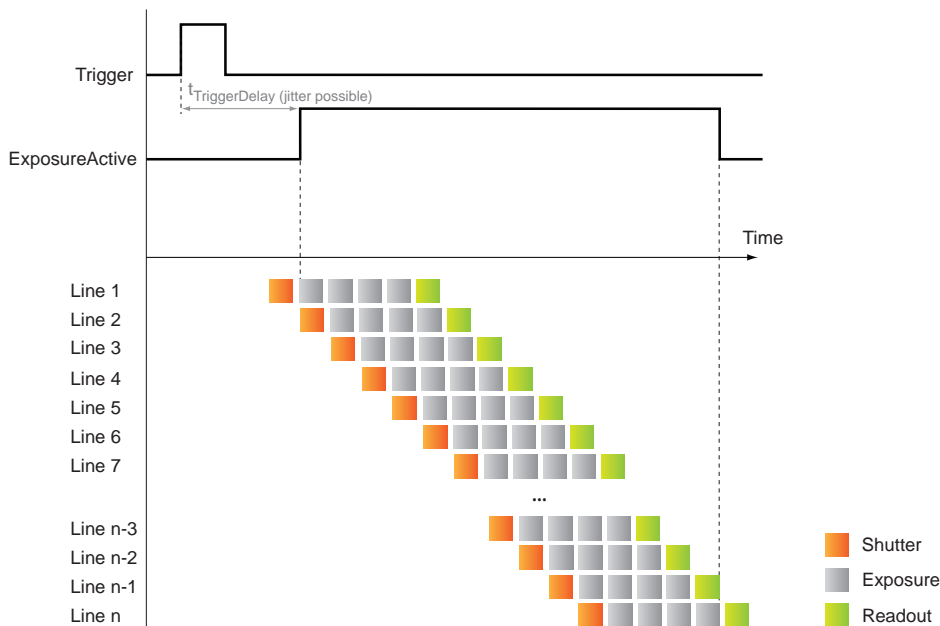

**Notice**  
 In Sensor Shutter Mode: Rolling Shutter  $t_{\text{TriggerDelay}}$  is not constant (expect  $t_{\text{exposure}} < t_{\text{Readout}}$ ).  
 $t_{\text{TriggerDelay}}$  depends on image settings like:

- ExposureTime
- PixelFormat
- ...

### 7.9.16 LineStatus

Returns the current status of the selected input or output Line.

<b>Name</b>	LineStatus
<b>Category</b>	DigitalIOControl
<b>Interface</b>	IBoolean
<b>Access</b>	Read only
<b>Unit</b>	-
<b>Values</b>	true = 1 (On) false = 0 (Off)

### 7.9.17 LineStatusAll

Returns the current status of all available Line signals at time of polling in a single bitfield.

<b>Name</b>	LineStatusAll
<b>Category</b>	DigitalIOControl
<b>Interface</b>	IInteger
<b>Access</b>	Read only
<b>Unit</b>	-
<b>Values</b>	Devices-Specific (HexNumber)

### 7.9.18 UserOutputSelector

Selects which bit of the User Output register will be set by UserOutputValue.

<b>Name</b>	UserOutputSelector
<b>Category</b>	DigitalIOControl
<b>Interface</b>	IEnumeration
<b>Access</b>	Read / Write
<b>Unit</b>	-
<b>Values</b>	UserOutput1    Selects the bit 0 of the User Output register. UserOutput2    Selects the bit 1 of the User Output register. UserOutput3    Selects the bit 2 of the User Output register. UserOutput4    Selects the bit 3 of the User Output register.

### 7.9.19 UserOutputValue

Sets the value of the bit selected by *UserOutputSelector*.

<b>Name</b>	UserOutputValue
<b>Category</b>	DigitalIOControl
<b>Interface</b>	IBoolean
<b>Access</b>	Read / Write
<b>Unit</b>	-
<b>Values</b>	true = 1 (On) false = 0 (Off)

### 7.9.20 UserOutputValueAll

Sets the value of all the bits of the User Output register.

<b>Name</b>	UserOutputValueAll
<b>Category</b>	DigitalIOControl
<b>Interface</b>	IInteger
<b>Access</b>	Read only
<b>Unit</b>	-
<b>Values</b>	0 ... 4294967295 (Increment: 1)

## 7.10 Category: EventControl

This chapter describes how to control the generation of Events to the host application. An Event is a message that is sent to the host application to notify it of the occurrence of an internal event.

### General Information

The asynchronous message channel is described in the GigE Vision® standard and offers the possibility of event signaling. There is a timestamp (64 bits) for each announced event, which contains the accurate time the event occurred. Each event can be activated and deactivated separately.

Each event can be activated and deactivated separately (*EventSelector*).

The charts below show some timings for the event signaling by the asynchronous message channel. Vendor-specific events are explained.

### EventLost

This signal can be put out when a selected event was lost. The cause may be that too many events occur.

### TriggerReady

This event signals whether the camera is able to process incoming trigger signals or not.

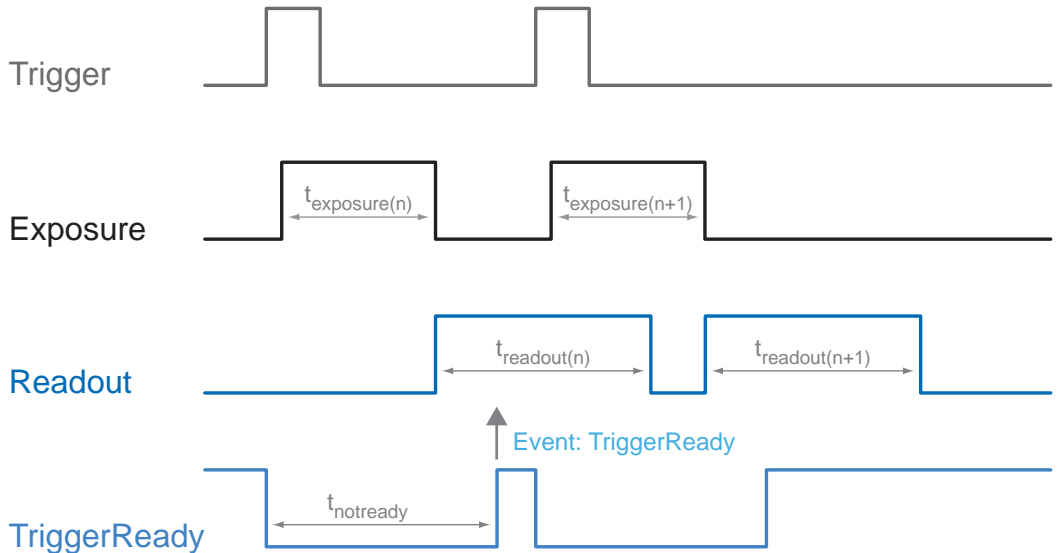

### TriggerSkipped

If the camera is unable to process incoming trigger signals, which means the camera should be triggered within the interval  $t_{\text{notready}}$ , these triggers are skipped. On Baumer CX cameras the user will be informed about this fact by means of the event "TriggerSkipped".

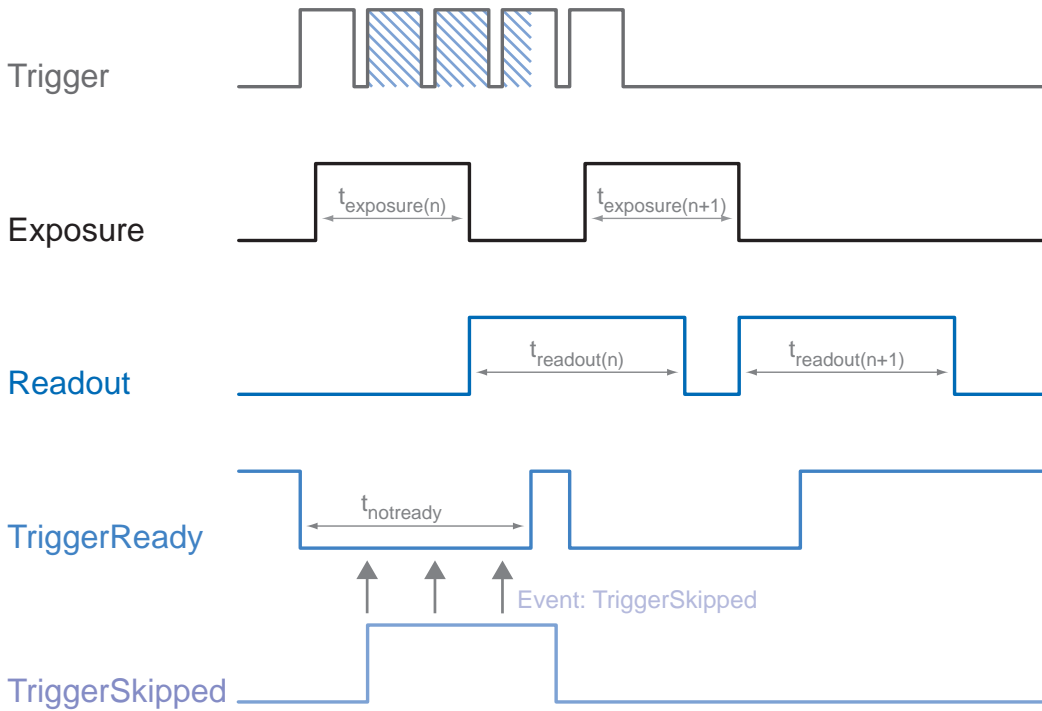

### TriggerOverlapped

This signal is active, as long as the sensor is exposed and read out at the same time, which means the camera is operated overlapped.

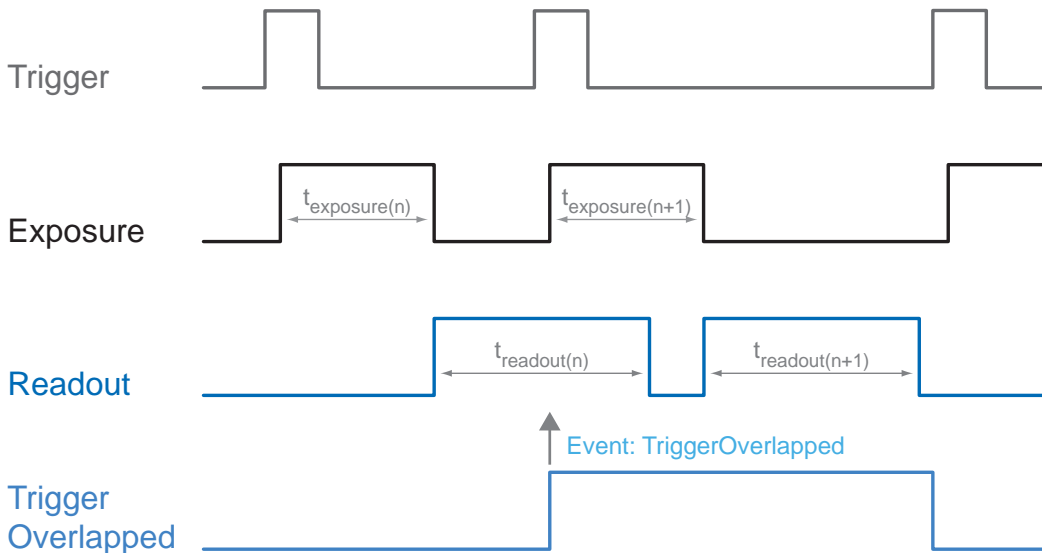

Once a valid trigger signal occurs not within a readout, the "TriggerOverlapped" signal changes to state low.

### ReadoutActive

While the sensor is read out, the camera signals this by means of "ReadoutActive".

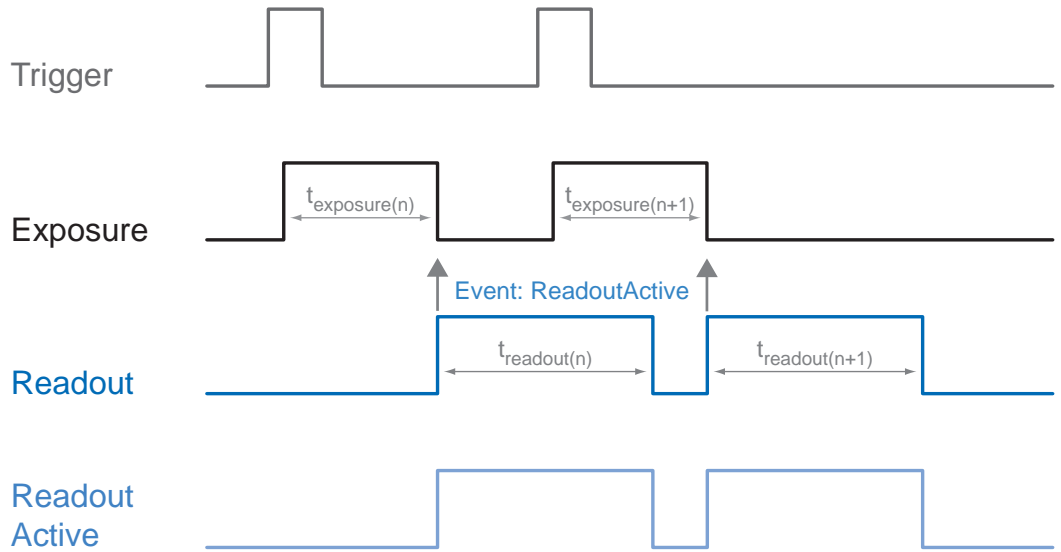

### TransferBufferFull

This event is issued only in trigger mode. It signals that no buffer is available.

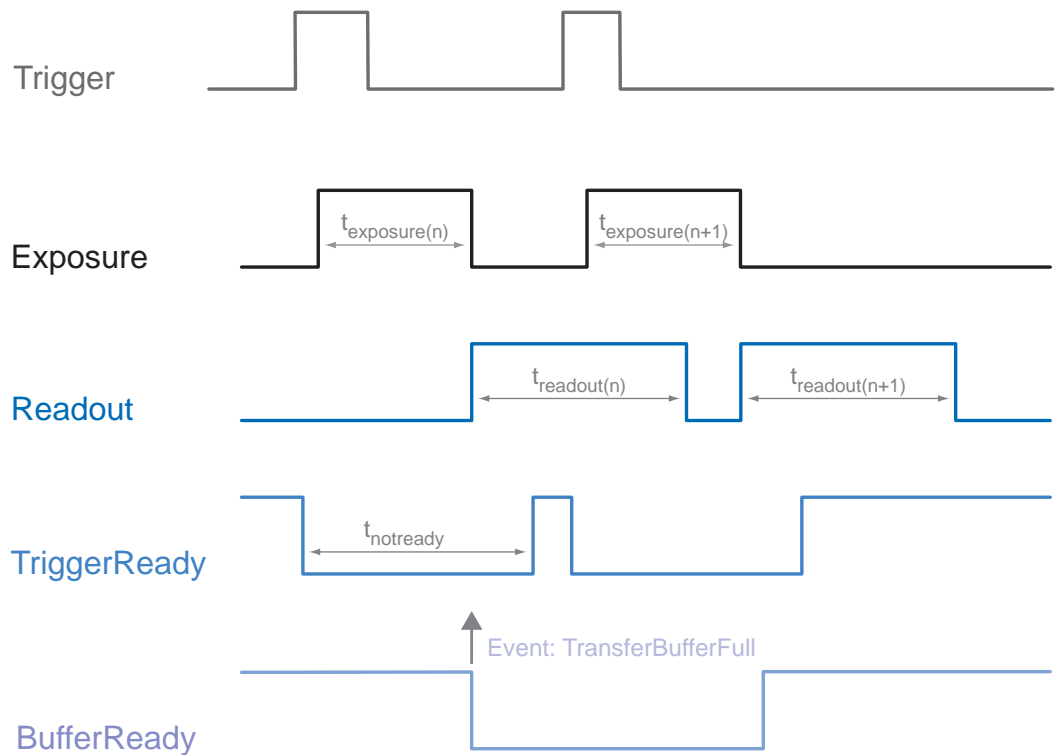



## TransferBufferReady

This event is issued only in trigger mode. It signals that buffer available.

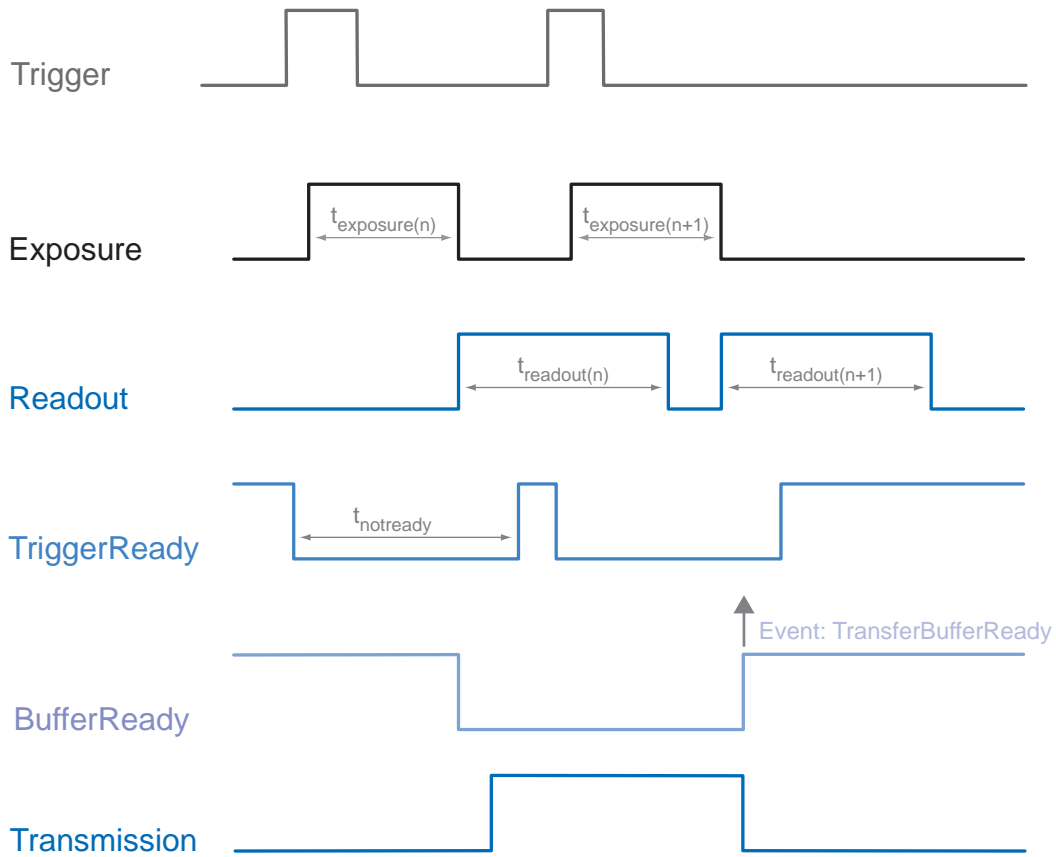

### 7.10.20.1 DeviceTemperatureStatusChanged

To prevent damage on the hardware due to high temperatures, the camera is equipped with an emergency shutdown. The *DeviceTemperatureStatusTransitionSelector* (Category: *Device Control*) feature allows you to select different thresholds for temperatures:

*NormalToHigh*: freely programmable value

*HighToExceeded*: fixed value (camera shutdown if exceeded)

*ExceededToNormal*: freely programmable value, temperature for error-free re-activation of the camera.

In the *DeviceTemperatureStatusTransition* feature, the temperatures for the programmable temperature transitions are set.

The event *EventDeviceTemperatureStatusChanged* is always generated when *DeviceTemperatureStatus* changes.

If the temperature rises above the value set at *HighToExceeded*, the *DeviceTemperatureExceeded* feature is set to *True*, the image recording is stopped, and the LED is set to red.

For further use, the camera must be disconnected from the power supply after cooling down or a device reset should be carried out.

The sufficient cooling is recognizable when the event *DeviceTemperatureStatus-Changed* (Device Temperature < *ExceededToNormal*) is output.

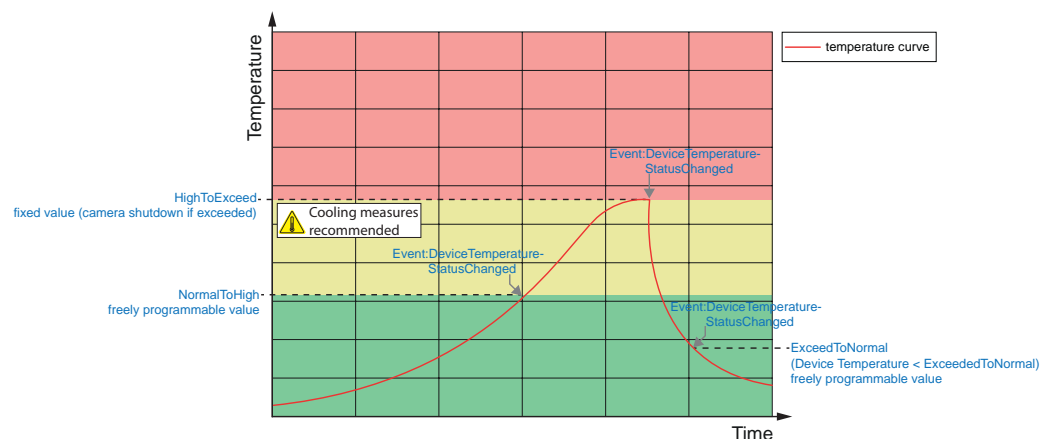

### 7.10.1 EventNotification

Activate or deactivate the notification to the host application of the occurrence of the selected Event.

<b>Name</b>	EventNotification	
<b>Category</b>	EventControl	
<b>Interface</b>	IEnumeration	
<b>Access</b>	Read / Write	
<b>Unit</b>	-	
<b>Values</b>	Off	The selected Event notification is disabled.
	On	The selected Event notification is enabled.

### 7.10.2 EventSelector

Selects which Event to signal to the host application.

<b>Name</b>	EventSelector
<b>Category</b>	EventControl
<b>Interface</b>	IEnumeration
<b>Access</b>	Read / Write
<b>Unit</b>	-
<b>Values</b>	see table below

V CXG / .XC / .PTP	V CXG.I / .I.XT / .PTP	V CXU
DeviceTemperatureStatus-Changed (≥ Rel. 2)	DeviceTemperatureStatus-Changed (≥ Rel. 2)	DeviceTemperatureStatus-Changed (≥ Rel. 2)
EventLost	EventLost	EventLost
ExposureEnd	ExposureEnd	ExposureEnd
ExposureStart	ExposureStart	ExposureStart
FrameEnd	FrameEnd	FrameEnd
FrameStart	FrameStart	FrameStart
FrameTransferSkipped	FrameTransferSkipped	FrameTransferSkipped
Error	Error	-
GigEVisionHeartbeatTime-Out	GigEVisionHeartbeatTime-Out	-
Line0..3 FallingEdge	Line0..7 FallingEdge	Line0..3 FallingEdge
Line0..3 RisingEdge	Line0..7 RisingEdge	Line0..3 RisingEdge
PrimaryApplicationSwitch	PrimaryApplicationSwitch	-
PtpServoStatusChanged*	PtpServoStatusChanged*	-
PtpStatusChanged*	PtpStatusChanged*	-
<div style="border: 1px solid black; padding: 5px;"> <b>Notice</b>                      There is a possibility that a large number of events <i>PtpStatusChanged</i> will be issued as long as <i>PtpServoStatus</i> ≠ <i>Locked</i>.                 </div>		-
TransferBufferFull	TransferBufferFull	TransferBufferFull
TransferBufferReady	TransferBufferReady	TransferBufferReady
TriggerOverlapped	TriggerOverlapped	TriggerOverlapped
TriggerReady	TriggerReady,	TriggerReady
TriggerSkipped	TriggerSkipped	TriggerSkipped

\*) .PTP only

### 7.10.3 LostEventCounter

Counts lost events.

<b>Name</b>	LostEventCounter
<b>Category</b>	EventControl
<b>Interface</b>	Integer
<b>Access</b>	Read only
<b>Unit</b>	-
<b>Values</b>	0 ... 9223372036854775807 (Increment: 1)

## 7.11 Category: ImageFormatControl

This chapter describes how to influence and determine the image size and format.

### Region of Interest (OffsetX / OffsetY / Width / Height) - General Information

You can use the "Region of Interest" (ROI) function to predefine a so-called region of interest or partial scan. This ROI is an area of pixels on the sensor. When an image is acquired, only the information regarding these pixels is transferred to the PC. Not all of the lines on the sensor are read out, which therefore decreases the readout time ( $t_{\text{readout}}$ ). This increases the frame rate.

This function is used if only a particular region of the field of view is of interest. It also reduces the resolution.

The ROI is specified using four values:

- OffsetX - x-coordinate of the first relevant pixel
- OffsetY - y-coordinate of the first relevant pixel
- Width - horizontal size of the ROI
- Height - vertical size of the ROI

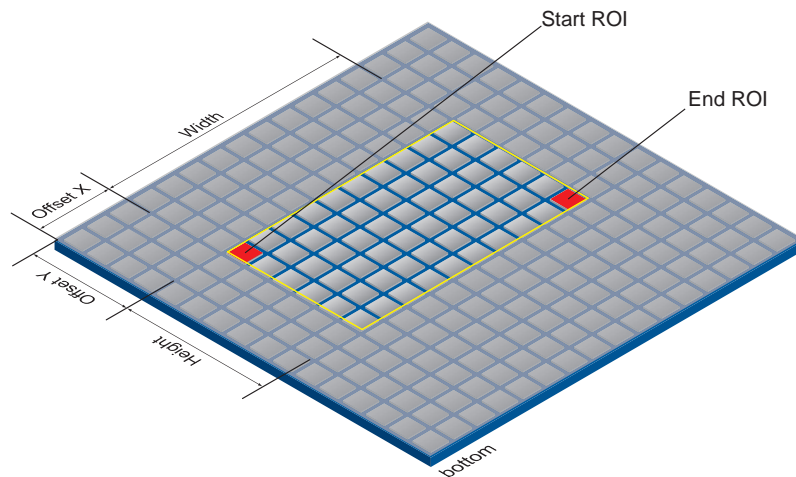

### ROI Readout

In the illustration below, the readout time would decrease to 40% of a full frame readout.

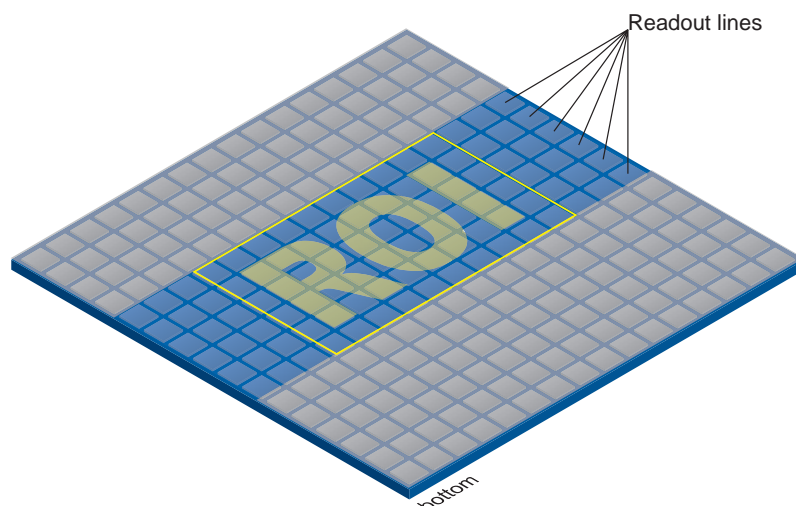

## Binning (BinningHorizontal / BinningVertical) - General Information

On digital cameras, you can find several operations for progressing sensitivity. One of them is the so-called "Binning". Here, the charge carriers of neighboring pixels are aggregated. Thus, the progression is greatly increased by the amount of binned pixels. By using this operation, the progression in sensitivity is coupled to a reduction in resolution. Higher sensitivity enables shorter exposure times.

Baumer cameras support three types of Binning - vertical, horizontal and bidirectional.







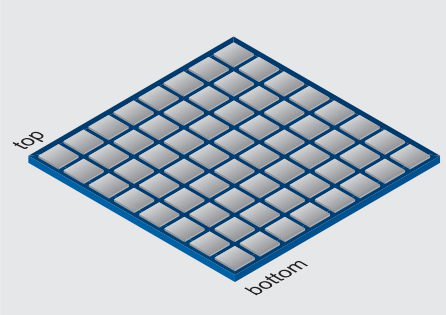

In unidirectional binning, vertically or horizontally neighboring pixels are aggregated and reported to the software as one single "superpixel".

In bidirectional binning, a square of neighboring pixels is aggregated.

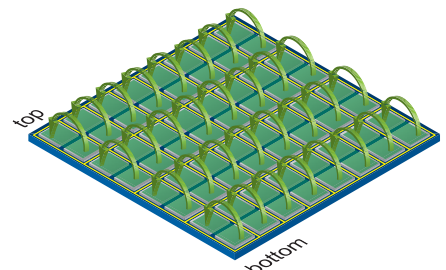
### Notice

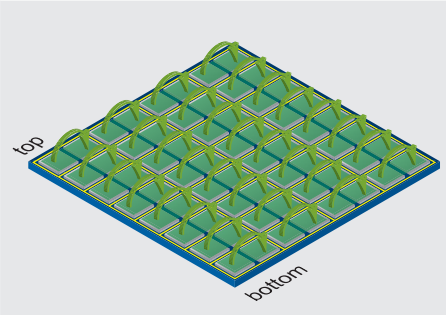
Occuring deviations in brightness after binning can be corrected with *Brightness Correction* function.

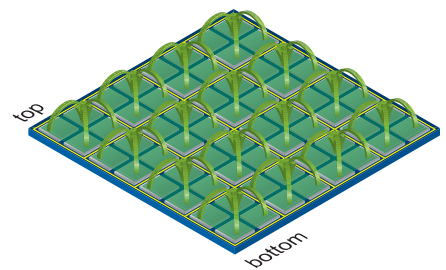
## Monochrome Binning

Binning	Illustration	Output	
without			Full frame image, no binning of pixels.
1x2			Vertical binning causes a vertically compressed image with doubled brightness.
2x1			Horizontal binning causes a horizontally compressed image with doubled brightness.
2x2			Bidirectional binning causes both a horizontally and vertically compressed image with quadruple brightness.

## Color Binning

Color Binning is calculating on the camera (no higher frame rates) – The sensor does not support this binning operation.

### Color calculated pixel formats

In pixel formats, which are not raw formats (e.g. RGB8), the three calculated color values (R, G, B) of a pixel will be added with those of the corresponding neighbor pixel during binning.

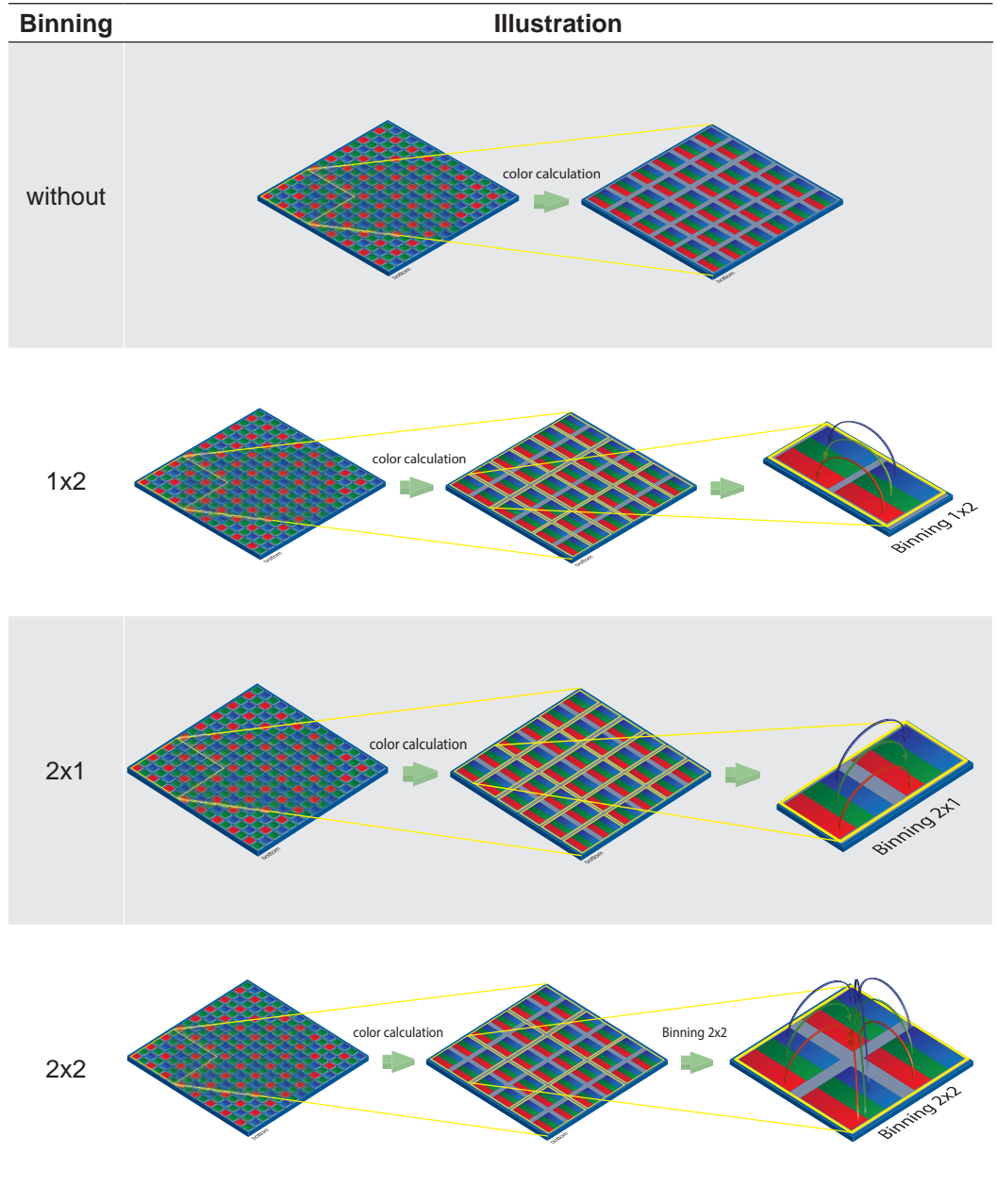

## RAW pixel formats

In the raw pixel formats (e.g. BayerRG8) the color values of neighboring pixels with the same color are combined.

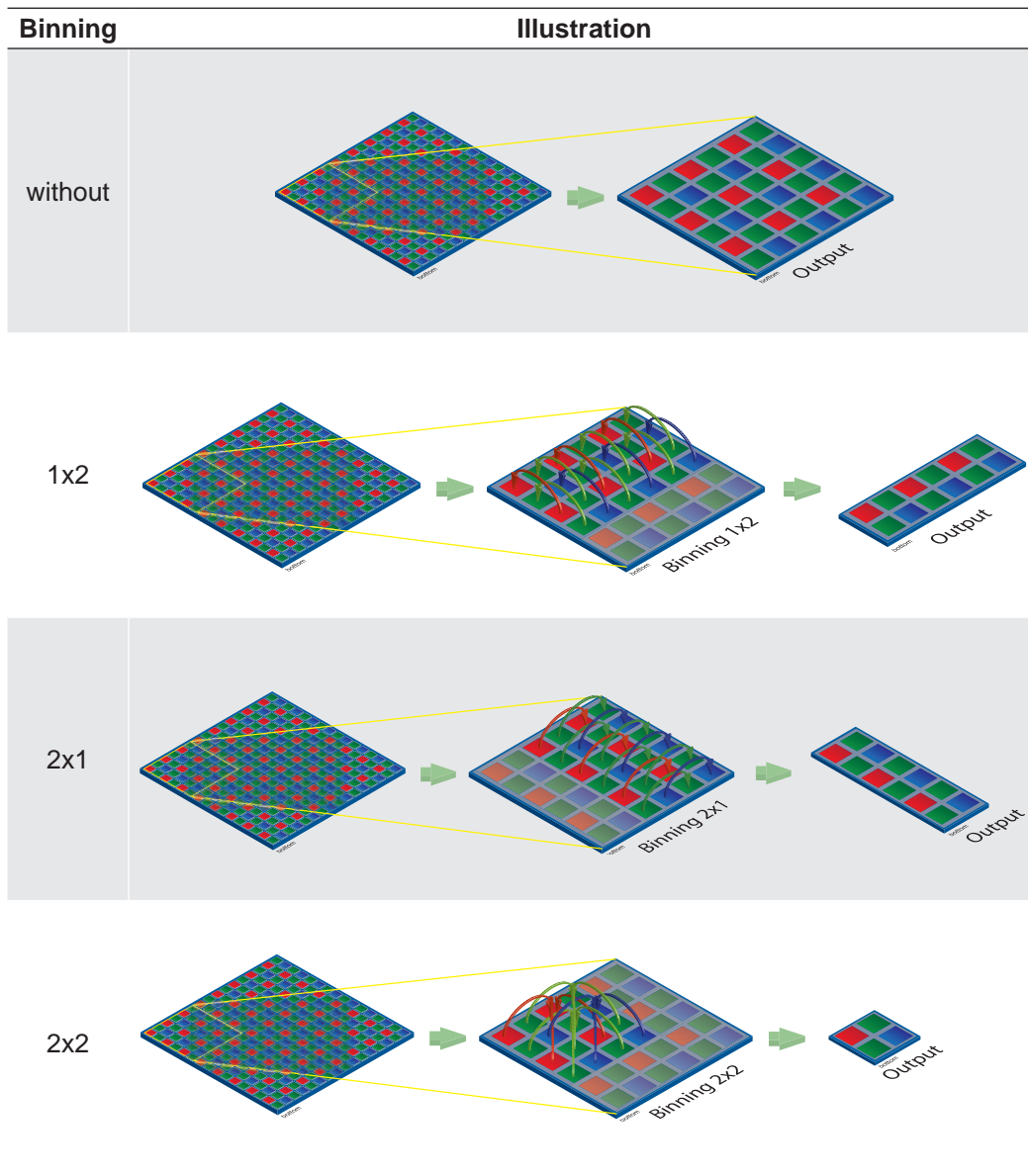

### 7.11.1 BinningHorizontal

Number of horizontal photo-sensitive cells to combine together. This increases the intensity (or signal to noise ratio) of the pixels and reduces the horizontal resolution (width) of the image.

<b>Name</b>	BinningHorizontal
<b>Category</b>	ImageFormatControl
<b>Interface</b>	Integer
<b>Access</b>	Read / Write
<b>Unit</b>	-
<b>Values</b>	see tables below (Increment: 1)

### 7.11.1.1 VCXG / .XC / .I / .I.XT / .PTP / .I.PTP

#### Notice

On the VCXG-15M binning is calculated in the sensor. In contrast to binning in the FPGA, the binning in the sensor increases the frame rate.

	BinningSelector [Region0]	BinningSelector [Sensor]
<b>Monochrome</b>		
VCXG-02M	1 ... 2	1 ... 1
VCXG-04M	1 ... 2	1 ... 1
VCXG-13M / .I/.I.XT	1 ... 2	1 ... 1
VCXG-13NIR	1 ... 2	1 ... 1
VCXG-14SWIR.XC	1 ... 2	1 ... 1
VCXG-15M / .I/.I.XT	1 ... 2	1 ... 2 <sup>*</sup>
VCXG-22M.R	1 ... 2	1 ... 1
VCXG-23M	1 ... 2	1 ... 1
VCXG-24M	1 ... 2	1 ... 1
VCXG-25M / .I/.I.XT	1 ... 2	1 ... 1
VCXG-32M / .I/.I.XT/.PTP/.I.PTP	1 ... 2	1 ... 1
VCXG-50MP	1 ... 2	1 ... 1
VCXG-51M / .XC / .I/.I.XT/.PTP/.I.PTP	1 ... 2	1 ... 1
VCXG-53M / .I/.I.XT	1 ... 2	1 ... 1
VCXG-53NIR	1 ... 2	1 ... 1
VCXG-65M.R	1 ... 2	1 ... 1
VCXG-82M / .I/.I.XT	1 ... 2	1 ... 2
VCXG-91M	1 ... 2	1 ... 1
VCXG-124M / .I/.I.XT/.PTP/.I.PTP	1 ... 2	1 ... 1
VCXG-125M.R	1 ... 2	1 ... 1
VCXG-127M / .I/.I.XT	1 ... 2	1 ... 2
VCXG-201M.R / .I / .I.XT	1 ... 2	1 ... 1
VCXG-204M	1 ... 2	1 ... 2
VCXG-241M / .I/.I.XT	1 ... 2	1 ... 2
<b>Color</b>		
VCXG-02C	1 ... 2	1 ... 1
VCXG-04C	1 ... 2	1 ... 1
VCXG-13C / .I/.I.XT	1 ... 2	1 ... 1
VCXG-15C / .I/.I.XT	1 ... 2	1 ... 1
VCXG-22C.R	1 ... 2	1 ... 1
VCXG-23C	1 ... 2	1 ... 1
VCXG-24C	1 ... 2	1 ... 1
VCXG-25C / .I/.I.XT	1 ... 2	1 ... 1
VCXG-32C / .I/.I.XT/.PTP/.I.PTP	1 ... 2	1 ... 1
VCXG-51C / .I/.I.XT/.PTP/.I.PTP	1 ... 2	1 ... 1
VCXG-53C / .I/.I.XT	1 ... 2	1 ... 1
VCXG-65C.R	1 ... 2	1 ... 1
VCXG-82C / .I/.I.XT	1 ... 2	1 ... 1
VCXG-91C	1 ... 2	1 ... 1
VCXG-124C / .I/.I.XT/.PTP/.I.PTP	1 ... 2	1 ... 1
VCXG-125C.R	1 ... 2	1 ... 1
VCXG-127C / .I/.I.XT	1 ... 2	1 ... 1
VCXG-91C	1 ... 2	1 ... 1
VCXG-201C.R / .I/.I.XT	1 ... 2	1 ... 1
VCXG-204C	1 ... 2	1 ... 1
VCXG-241C / .I/.I.XT	1 ... 2	1 ... 1

<sup>\*</sup>) *BinningVertical* is also switched to 2



### 7.11.1.2 VCXU

#### Notice

On the VCXU-15M, VCXU-90M, VCXU-123M, binning is calculated in the sensor. In contrast to binning in the FPGA, the binning in the sensor increases the frame rate.

Camera Type	BinningSelector [Region0]	BinningSelector [Sensor]
<b>Monochrome</b>		
VCXU-02M	1 ... 2	1 ... 1
VCXU-04M	1 ... 2	1 ... 1
VCXU-13M	1 ... 2	1 ... 1
VCXU-15M	1 ... 2	1 ... 2 <sup>*</sup>
VCXU-22M.R	1 ... 2	1 ... 1
VCXU-23M	1 ... 2	1 ... 1
VCXU-24M	1 ... 2	1 ... 1
VCXU-25M	1 ... 2	1 ... 1
VCXU-31M	1 ... 2	1 ... 1
VCXU-32M	1 ... 2	1 ... 1
VCXU-50M	1 ... 2	1 ... 1
VCXU-50MP	1 ... 2	1 ... 1
VCXU-51M	1 ... 2	1 ... 1
VCXU-53M	1 ... 2	1 ... 1
VCXU-65M.R	1 ... 2	1 ... 1
VCXU-90M	1 ... 2	1 ... 2 <sup>*</sup>
VCXU-91M	1 ... 2	1 ... 1
VCXU-123M	1 ... 2	1 ... 2 <sup>*</sup>
VCXU-124M	1 ... 2	1 ... 1
VCXU-125M.R	1 ... 2	1 ... 1
VCXU-201M.R	1 ... 2	1 ... 1
<b>Color</b>		
VCXU-02C	1 ... 2	1 ... 1
VCXU-04C	1 ... 2	1 ... 1
VCXU-13C	1 ... 2	1 ... 1
VCXU-15C	1 ... 2	1 ... 1
VCXU-22C.R	1 ... 2	1 ... 1
VCXU-23C	1 ... 2	1 ... 1
VCXU-24C	1 ... 2	1 ... 1
VCXU-25C	1 ... 2	1 ... 1
VCXU-31C	1 ... 2	1 ... 1
VCXU-32C	1 ... 2	1 ... 1
VCXU-50C	1 ... 2	1 ... 1
VCXU-51C	1 ... 2	1 ... 1
VCXU-53C	1 ... 2	1 ... 1
VCXU-65C.R	1 ... 2	1 ... 1
VCXU-90C	1 ... 2	1 ... 1
VCXU-91C	1 ... 2	1 ... 1
VCXU-123C	1 ... 2	1 ... 1
VCXU-124C	1 ... 2	1 ... 1
VCXU-125C.R	1 ... 2	1 ... 1
VCXU-201C.R	1 ... 2	1 ... 1

<sup>\*</sup> *BinningVertical* is also switched to 2

### 7.11.2 BinningHorizontalMode

Sets the mode to use to combine horizontal photo-sensitive cells together when Binning-Horizontal is used.

<b>Name</b>	BinningHorizontalMode	
<b>Category</b>	ImageFormatControl	
<b>Interface</b>	IEnumeration	
<b>Access</b>	Read / Write	
<b>Unit</b>	-	
<b>Values</b>	Average	The response from the combined cells will be averaged, resulting in increased signal/noise ratio.
	Sum	The response from the combined cells will be added, resulting in increased sensitivity.

### 7.11.3 BinningSelector

Selects which binning engine is controlled by the BinningHorizontal and BinningVertical features.

<b>Name</b>	BinningSelector	
<b>Category</b>	ImageFormatControl	
<b>Interface</b>	IEnumeration	
<b>Access</b>	Read / Write	
<b>Unit</b>	-	
<b>Values</b>	Region0	Selected feature will control the region 0 (FPGA) binning.
	Sensor	Selected features will control the sensor binning.

#### Known issues

The following models are affected:

- VCXU-90M
- VCXU-123M

Due to the sensor applied, some camera models have an offset of one pixel when binning performed in the sensor (`BinningSelector = [Sensor]`).

This behavior also occurs with a set Region of Interest (ROI).

Use binning via the FPGA (`BinningSelector = [Region0]`) if this behavior occurs in your application.

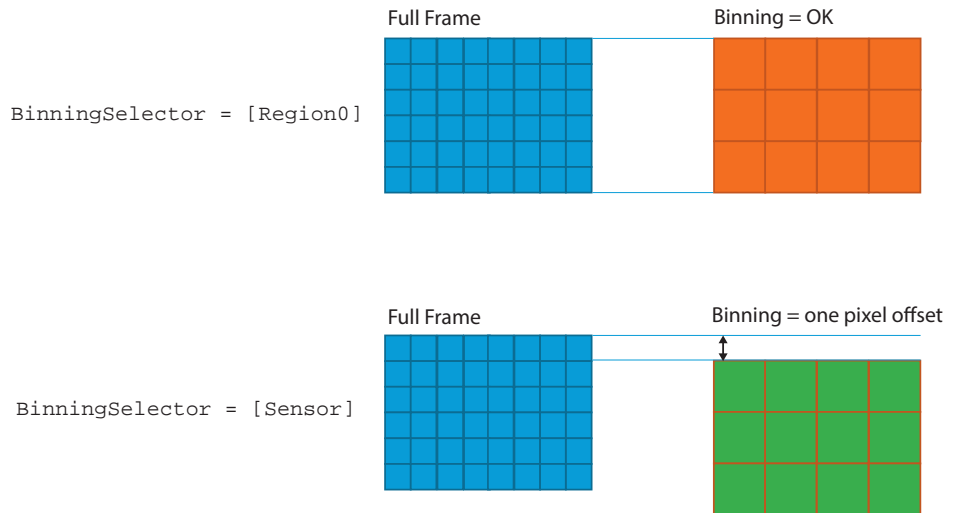

## 7.11.4 BinningVertical

Number of vertical photo-sensitive cells to combine together. This increases the intensity (or signal to noise ratio) of the pixels and reduces the vertical resolution (height) of the image.

<b>Name</b>	BinningVertical
<b>Category</b>	ImageFormatControl
<b>Interface</b>	Integer
<b>Access</b>	Read / Write
<b>Unit</b>	-
<b>Values</b>	see tables below (Increment: 1)

### 7.11.4.1 VCXG / .I / .I.XT / .PTP / .I.PTP

#### Notice

On the VCXG-15M binning is calculated in the sensor. In contrast to binning in the FPGA, the binning in the sensor increases the frame rate.

Camera Type	BinningSelector [Region0]	BinningSelector [Sensor]
<b>Monochrome</b>		
VCXG-02M	1 ... 2	1 ... 1
VCXG-04M	1 ... 2	1 ... 1
VCXG-13M / .I/.I.XT	1 ... 2	1 ... 1
VCXG-13NIR	1 ... 2	1 ... 1
VCXG-15M / .I/.I.XT	1 ... 2	1 ... 2*
VCXG-22M.R	1 ... 2	1 ... 1
VCXG-23M	1 ... 2	1 ... 1
VCXG-24M	1 ... 2	1 ... 1
VCXG-25M / .I/.I.XT	1 ... 2	1 ... 1
VCXG-32M / .I/.I.XT/.PTP/.I.PTP	1 ... 2	1 ... 1
VCXG-50MP	1 ... 2	1 ... 1
VCXG-51M /.XC / .I/.I.XT/.PTP/.I.PTP	1 ... 2	1 ... 1
VCXG-53M / .I/.I.XT	1 ... 2	1 ... 1
VCXG-53NIR	1 ... 2	1 ... 1
VCXG-65M.R	1 ... 2	1 ... 1
VCXG-82M / .I/.I.XT	1 ... 2	1 ... 2
VCXG-91M	1 ... 2	1 ... 1
VCXG-124M / .I/.I.XT/.PTP/.I.PTP	1 ... 2	1 ... 1
VCXG-125M.R	1 ... 2	1 ... 1
VCXG-127M / .I/.I.XT	1 ... 2	1 ... 2
VCXG-201M.R / .I/.I.XT	1 ... 2	1 ... 1
VCXG-204M	1 ... 2	1 ... 2
VCXG-241M / .I/.I.XT	1 ... 2	1 ... 2

<sup>\*)</sup> *BinningHorizontal* is also switched to 2

Camera Type	BinningSelector [Region0]	BinningSelector [Sensor]
<b>Color</b>		
VCXG-02C	1 ... 2	1 ... 1
VCXG-04C	1 ... 2	1 ... 1
VCXG-13C / .I/.I.XT	1 ... 2	1 ... 1
VCXG-15C / .I/.I.XT	1 ... 2	1 ... 1
VCXG-22C.R	1 ... 2	1 ... 1
VCXG-23C	1 ... 2	1 ... 1
VCXG-24C	1 ... 2	1 ... 1
VCXG-25C / .I/.I.XT	1 ... 2	1 ... 1
VCXG-32C / .I/.I.XT/.PTP/.I.PTP	1 ... 2	1 ... 1
VCXG-51C / .I/.I.XT/.PTP/.I.PTP	1 ... 2	1 ... 1
VCXG-53C / .I/.I.XT	1 ... 2	1 ... 1
VCXG-65C.R	1 ... 2	1 ... 1
VCXG-82C / .I/.I.XT	1 ... 2	1 ... 1
VCXG-91C	1 ... 2	1 ... 1
VCXG-124C / .I/.I.XT/.PTP/.I.PTP	1 ... 2	1 ... 1
VCXG-125C.R	1 ... 2	1 ... 1
VCXG-127C / .I/.I.XT	1 ... 2	1 ... 1
VCXG-201C.R / .I/.I.XT	1 ... 2	1 ... 1
VCXG-204C	1 ... 2	1 ... 1
VCXG-241C / .I/.I.XT	1 ... 2	1 ... 1

#### 7.11.4.2 VCXU

##### Notice

On the VCXU-15M, VCXU-90M, VCXU-123M, binning is calculated in the sensor. In contrast to binning in the FPGA, the binning in the sensor increases the frame rate.

Camera Type	BinningSelector [Region0]	BinningSelector [Sensor]
<b>Monochrome</b>		
VCXU-02M	1 ... 2	1 ... 1
VCXU-04M	1 ... 2	1 ... 1
VCXU-13M	1 ... 2	1 ... 1
VCXU-15M	1 ... 2	1 ... 2*
VCXU-22M.R	1 ... 2	1 ... 1
VCXU-23M	1 ... 2	1 ... 1
VCXU-24M	1 ... 2	1 ... 1
VCXU-25M	1 ... 2	1 ... 1
VCXU-31M	1 ... 2	1 ... 1
VCXU-32M	1 ... 2	1 ... 1
VCXU-50M	1 ... 2	1 ... 1
VCXU-50MP	1 ... 2	1 ... 1
VCXU-51M	1 ... 2	1 ... 1
VCXU-53M	1 ... 2	1 ... 1
VCXU-65M.R	1 ... 2	1 ... 1
VCXU-90M	1 ... 2	1 ... 2*
VCXU-91M	1 ... 2	1 ... 1
VCXU-123M	1 ... 2	1 ... 2*
VCXU-124M	1 ... 2	1 ... 1
VCXU-125M.R	1 ... 2	1 ... 1
VCXU-201M.R	1 ... 2	1 ... 1

Camera Type	BinningSelector [Region0]	BinningSelector [Sensor]
<b>Color</b>		
VCXU-02C	1 ... 2	1 ... 1
VCXU-04C	1 ... 2	1 ... 1
VCXU-13C	1 ... 2	1 ... 1
VCXU-15C	1 ... 2	1 ... 1
VCXU-22C.R	1 ... 2	1 ... 1
VCXU-23C	1 ... 2	1 ... 1
VCXU-24C	1 ... 2	1 ... 1
VCXU-25C	1 ... 2	1 ... 1
VCXU-31C	1 ... 2	1 ... 1
VCXU-32C	1 ... 2	1 ... 1
VCXU-50C	1 ... 2	1 ... 1
VCXU-51C	1 ... 2	1 ... 1
VCXU-53C	1 ... 2	1 ... 1
VCXU-65C.R	1 ... 2	1 ... 1
VCXU-90C	1 ... 2	1 ... 1
VCXU-91C	1 ... 2	1 ... 1
VCXU-123C	1 ... 2	1 ... 1
VCXU-124C	1 ... 2	1 ... 1
VCXU-125C.R	1 ... 2	1 ... 1
VCXU-201C.R	1 ... 2	1 ... 1

<sup>\*)</sup> *BinningHorizontal* is also switched to 2

### 7.11.5 BinningVerticalMode

The response from the combined cells will be averaged, resulting in increased signal/noise ratio.

<b>Name</b>	BinningVerticalMode	
<b>Category</b>	ImageFormatControl	
<b>Interface</b>	IEnumeration	
<b>Access</b>	Read / Write	
<b>Unit</b>	-	
<b>Values</b>	Average	The response from the combined cells will be averaged, resulting in increased signal/noise ratio.
	Sum	The response from the combined cells will be added, resulting in increased sensitivity.

### 7.11.6 Category: ImageFormatControl → CalibrationControl (MP cameras only)

That is the category that contains features to control the calibration of the four polarized light channels.

The Baumer polarization cameras are based on the Sony IMC250MZR Sensor. This sensor is coated with a metal-mesh which filters the polarization information on 4 adjacent pixels. The polarization angle is filtered with an alignment of 0°, 45°, 90° and 135°.

With this information the following data can be calculated:

Baumer GAPI v2.9	Baumer GAPI v2.10	Baumer GAPI v2.11	Baumer GAPI v2.12
ADOLP	ADOLP	ADOLP	ADOLP
AOP	AOP	AOP	AOP
DOLP	DOLP	DOLP	DOLP
Intensity	Intensity	Intensity	Intensity
	POL0	POL0	POL0
	POL45	POL45	POL45
	POL90	POL90	POL90
	POL135	POL135	POL135
	POLMIN	POLMIN	POLMIN
	POLMAX	POLMAX	POLMAX
			POL
			UNPOL

The Camera Explorer can also be used to view and save polarization data in these formats. The configuration is done in the *Polarization* widget.

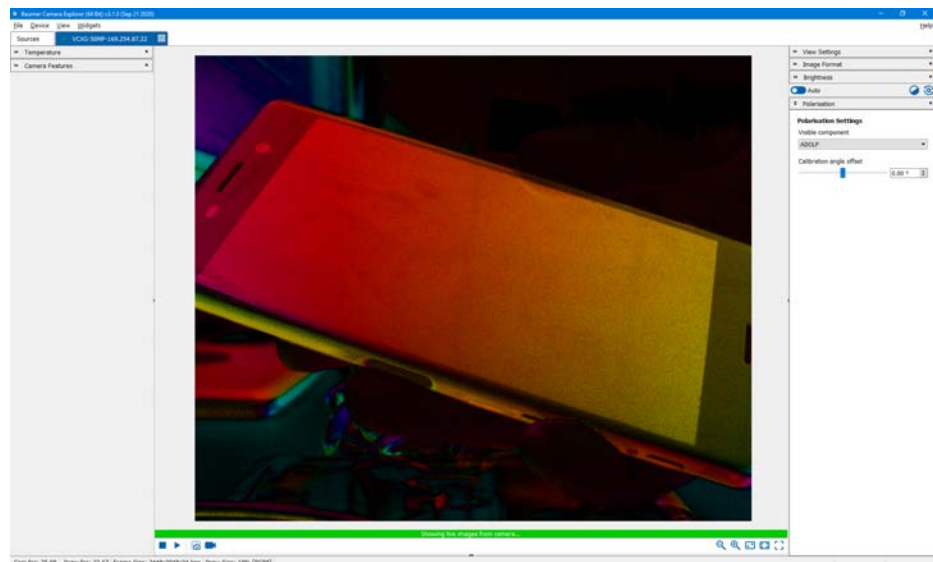

### 7.11.6.1 CalibrationAngleOfPolarizationOffset

Adds a calibration offset to compensate for an individual "roll" angle of the camera, introduced by mounting tolerances. The offset is added to all type of output data that incorporates an angle, like false color representation and angle of polarization data. The offset is without effect to raw data and to degree of linear polarization data.

<b>Name</b>	CalibrationAngleOfPolarizationOffset
<b>Category</b>	ImageFormatControl → CalibrationControl
<b>Interface</b>	IFloat
<b>Access</b>	Read / Write
<b>Unit</b>	°
<b>Values</b>	-180 ... 179.9 (Increment: 0.1)

### 7.11.6.2 CalibrationEnable

Activates the calibration of the four polarized light channels by applying matrix calculations and an angle offset.

<b>Name</b>	CalibrationEnable
<b>Category</b>	ImageFormatControl → CalibrationControl
<b>Interface</b>	IBoolean
<b>Access</b>	Read / Write
<b>Unit</b>	-
<b>Values</b>	true = 1 (On) false = 0 (Off)

### 7.11.6.3 CalibrationMatrixValue

Represents the value of the selected gain factor inside the calibration matrix.

<b>Name</b>	CalibrationMatrixValue
<b>Category</b>	ImageFormatControl → CalibrationControl
<b>Interface</b>	IFloat
<b>Access</b>	Read / Write
<b>Unit</b>	-
<b>Values</b>	-8 ... 7.99999999627470970154 (Increment: 0.00001)

#### 7.11.6.4 CalibrationMatrixValueSelector

Selects the gain factor of the calibration matrix.

<b>Name</b>	CalibrationMatrixValueSelector
<b>Category</b>	ImageFormatControl → CalibrationControl
<b>Interface</b>	IEnumeration
<b>Access</b>	Read / Write
<b>Unit</b>	-
<b>Values</b>	Gain                      Gain00 ... Gain23

#### 7.11.7 ComponentEnable (MP cameras only)

Controls, if streaming of the component selected by feature ComponentSelector is active.

<b>Name</b>	ComponentEnable
<b>Category</b>	ImageFormatControl
<b>Interface</b>	IBoolean
<b>Access</b>	Read only
<b>Unit</b>	-
<b>Values</b>	true = 1 (On) false = 0 (Off)

#### 7.11.8 ComponentSelector (MP cameras only)

Selects, which data acquisition component to use.

<b>Name</b>	ComponentSelector
<b>Category</b>	ImageFormatControl
<b>Interface</b>	IEnumeration
<b>Access</b>	Read / Write
<b>Unit</b>	-
<b>Values</b>	PolarizedRaw                      Acquisition of polarized light intensity. The polarizing filters are arranged in a 2-by-2 pattern: 135° and 0° on even lines, 90° and 45° on odd lines. The raw data is unprocessed.



### 7.11.9 Height

Height of the image provided by the device (in pixels). The selected value changes with the change of *Binning*.

#### Notice

The sum of *OffsetY* and *Height* must be smaller or equal than *HeightMax*.

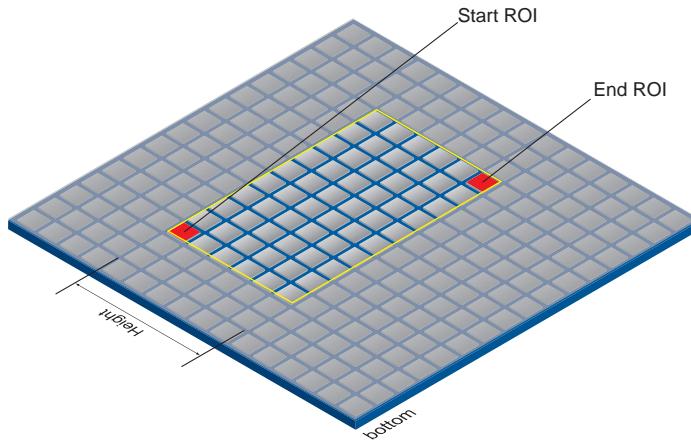

<b>Name</b>	Height
<b>Category</b>	ImageFormatControl
<b>Interface</b>	IInteger
<b>Access</b>	Read / Write
<b>Unit</b>	-
<b>Values</b>	see tables below

## 7.11.9.1 VCXG /.XC / .I/ .I.XT / .PTP / .I.PTP

### Notice

VCXU-201M.R (Rel. 4)  
VCXG-201C.R (Rel. 4)

In pixel formats:

- Mono8
- Mono10
- Bayer RG8
- Bayer RG10

and Region of Interest (ROI) (*Height* 1649 ... 3648) vertical partial scan will be done in the sensor.

This leads to an increase of the frame rate.

The other area (*Height* 1 ... 1648) is done in the FPGA and the frame rate does not increase.

In the other pixel formats, partial scan is done only in the FPGA and the frame rate does not increase either.

Camera Type	Values
<b>Monochrome</b>	
VCXG-02M	1*   2 ... 480 (Increment: 1*   2)
VCXG-04M	1*   2 ... 540 (Increment: 1*   2)
VCXG-13M / .I/.I.XT	1*   2 ... 1024 (Increment: 1*   2)
VCXG-13NIR	1 ... 1024 (Increment: 1)
VCXG-14SWIR	2 ... 1032 (Increment: 2)
VCXG-15M / .I/.I.XT	1*   4 ... 1080 (Increment: 1*   4)
VCXG-22M.R	2 ... 1080 (Increment: 2)
VCXG-23M	1*   2 ... 1200 (Increment: 1*   2)
VCXG-24M	1*   2 ... 1200 (Increment: 1*   2)
VCXG-25M / .I/.I.XT	1*   2 ... 1200 (Increment: 1*   2)
VCXG-32M / .I/.I.XT/.PTP/.I.PTP	1*   2 ... 1536 (Increment: 1*   2)
VCXG-51M / XC .I/.I.XT/.PTP/.I.PTP	1*   2 ... 2048 (Increment: 1*   2)
VCXG-50MP	1*   2 ... 2048 (Increment: 1*   2)
VCXG-53M / .I/.I.XT	1*   2 ... 2048 (Increment: 1*   2)
VCXG-53NIR	1 ... 2048 (Increment: 1*   2)
VCXG-65M.R	2 ... 2048 (Increment: 2)
VCXG-82M / .I/.I.XT	1 ... 2832 (Increment: 1)
VCXG-91M	1*   2 ... 2160 (Increment: 1*   2)
VCXG-124M / .I/.I.XT/.PTP/.I.PTP	1*   2 ... 3000 (Increment: 1*   2)
VCXG-125M.R	2 ... 3000 (Increment: 2)
VCXG-127M / .I/.I.XT	1 ... 2992 (Increment: 1)
VCXG-201M.R / .I/.I.XT	2 ... 3648 (Increment: 2)
VCXG-204M	1 ... 4496 (Increment: 1)
VCXG-241M / .I/.I.XT	1 ... 4600   4592 <sup>*)</sup> (Increment: 1)
<b>Color</b>	
VCXG-02C	2*   4 ... 480 (Increment: 2*   4)
VCXG-04C	2*   4 ... 540 (Increment: 2*   4)
VCXG-13C / .I/.I.XT	2*   4 ... 1024 (Increment: 2*   4)
VCXG-15C / .I/.I.XT	2*   4 ... 1080 (Increment: 2*   4)
VCXG-22C.R	4 ... 1080 (Increment: 4)
VCXG-23C	2*   4 ... 1200 (Increment: 2*   4)
VCXG-24C	2*   4 ... 1200 (Increment: 2*   4)
VCXG-25C / .I/.I.XT	2*   4 ... 1200 (Increment: 2*   4)
VCXG-32C / .I/.I.XT/.PTP/.I.PTP	2*   4 ... 1536 (Increment: 2*   4)
VCXG-51C / .I/.I.XT/.PTP/.I.PTP	2*   4 ... 2048 (Increment: 2*   4)
VCXG-53C / .I/.I.XT	2*   4 ... 2048 (Increment: 2*   4)
VCXG-65C.R	4 ... 2048 (Increment: 4)
VCXG-82C / .I/.I.XT	2 ... 4832 (Increment: 2)
VCXG-91C	2*   4 ... 2160 (Increment: 2*   4)
VCXG-124C / .I/.I.XT/.PTP/.I.PTP	2*   4 ... 3000 (Increment: 2*   4)
VCXG-125C.R	4 ... 3000 (Increment: 4)
VCXG-127C / .I/.I.XT	2 ... 2992 (Increment: 2)
VCXG-201C.R / .I/.I.XT	4 ... 3648 (Increment: 4)
VCXG-204C	2 ... 4496 (Increment: 2)
VCXG-241C / .I/.I.XT	2 ... 4592 (Increment: 2)

\*) ≥ Release 3

\*\*) ≥ Release 4

## 7.11.9.2 VCXU

Camera Type	Values
<b>Monochrome</b>	
VCXU-02M	1*   2 ... 480 (Increment: 1*   2)
VCXU-04M	1*   2 ... 540 (Increment: 1*   2)
VCXU-13M	1*   2 ... 1024 (Increment: 1*   2)
VCXU-15M	1*   4 ... 1080 (Increment: 1*   4)
VCXU-22M.R	2*   2 ... 1080 (Increment: 2*   2)
VCXU-23M	1*   2 ... 1200 (Increment: 1*   2)
VCXU-24M	1*   2 ... 1200 (Increment: 1*   2)
VCXU-25M	1*   2 ... 1200 (Increment: 1*   2)
VCXU-31M	1*   2 ... 1536 (Increment: 1*   2)
VCXU-32M	1*   2 ... 1536 (Increment: 1*   2)
VCXU-50M	1*   2 ... 2048 (Increment: 1*   2)
VCXU-50MP	1*   2 ... 2048 (Increment: 1*   2)
VCXU-51M	1*   2 ... 2048 (Increment: 1*   2)
VCXU-53M	1*   2 ... 2048 (Increment: 1*   2)
VCXU-65M.R	2*   2 ... 2048 (Increment: 2*   2)
VCXU-90M	1*   4 ... 2160 (Increment: 1*   4)
VCXU-91M	1*   2 ... 2160 (Increment: 1*   2)
VCXU-123M	1*   4 ... 3000 (Increment: 1*   4)
VCXU-124M	1*   2 ... 3000 (Increment: 1*   2)
VCXU-125M.R	2*   2 ... 3000 (Increment: 2*   2)
VCXU-201M.R	2*   2 ... 3648 (Increment: 2*   2)
<b>Color</b>	
VCXU-02C	2*   4 ... 480 (Increment: 2*   4)
VCXU-04C	2*   4 ... 540 (Increment: 2*   4)
VCXU-13C	2*   4 ... 1024 (Increment: 2*   4)
VCXU-15C	2*   4 ... 1080 (Increment: 2*   4)
VCXU-22C.R	4*   4 ... 1080 (Increment: 4*   4)
VCXU-23C	2*   4 ... 1200 (Increment: 2*   4)
VCXU-24C	2*   4 ... 1200 (Increment: 2*   4)
VCXU-25C	2*   4 ... 1200 (Increment: 2*   4)
VCXU-31C	2*   4 ... 1536 (Increment: 2*   4)
VCXU-32C	2*   4 ... 1536 (Increment: 2*   4)
VCXU-50C	2*   4 ... 2048 (Increment: 2*   4)
VCXU-51C	2*   4 ... 2048 (Increment: 2*   4)
VCXU-53C	2*   4 ... 2048 (Increment: 2*   4)
VCXU-65C.R	4*   4 ... 2048 (Increment: 4*   4)
VCXU-90C	2*   4 ... 2160 (Increment: 2*   4)
VCXU-91C	2*   4 ... 2160 (Increment: 2*   4)
VCXU-123C	2*   4 ... 3000 (Increment: 2*   4)
VCXU-124C	2*   4 ... 3000 (Increment: 2*   4)
VCXU-125C.R	4*   4 ... 3000 (Increment: 4*   4)
VCXU-201C.R	4*   4 ... 3648 (Increment: 4*   4)

<sup>\*)</sup> ≥ Release 3

### 7.11.10 HeightMax

Maximum height of the image (in pixels). This dimension is calculated after vertical binning, decimation or any other function changing the vertical dimension of the image.

<b>Name</b>	HeightMax
<b>Category</b>	ImageFormatControl
<b>Interface</b>	Integer
<b>Access</b>	Read only
<b>Unit</b>	-
<b>Values</b>	Resolution of the sensor in Y-direction. (see tables below)

#### 7.11.10.1 VCXG /.XC / .I / .I.XT / .PTP / .I.PTP

Camera Type	Values
<b>Monochrome</b>	
VCXG-02M	480
VCXG-04M	540
VCXG-13M / .I/.I.XT	1024
VCXG-14SWIR	1032
VCXG-13NIR	1024
VCXG-15M / .I/.I.XT	1080
VCXG-22M.R	1080
VCXG-23M	1200
VCXG-24M	1200
VCXG-25M / .I/.I.XT	1200
VCXG-32M / .I/.I.XT/.PTP/.I.PTP	1536
VCXG-50MP	2048
VCXG-51M /.XC / .I / .I.XT / .PTP / .I.PTP	2048
VCXG-53M / .I/.I.XT	2048
VCXG-53NIR	2048
VCXG-65M.R	2048
VCXG-82M / .I/.I.XT	2832
VCXG-91M	2160
VCXG-124M / .I/.I.XT/.PTP/.I.PTP	3000
VCXG-125M.R	3000
VCXG-127M / .I/.I.XT	2992
VCXG-201M.R.I/.I.XT	3648
VCXG-204M	4496
VCXG-241M / .I/.I.XT	4600   4592 <sup>1)</sup>

<sup>1)</sup> ≥ Release 4

Camera Type	Values
<b>Color</b>	
VCXG-02C	480
VCXG-04C	540
VCXG-13C / .I/.I.XT	1024
VCXG-15C / .I/.I.XT	1080
VCXG-22C.R	1080
VCXG-23C	1200
VCXG-24C	1200
VCXG-25C / .I/.I.XT	1200
VCXG-32C / .I/.I.XT/.PTP/.I.PTP	1536
VCXG-51C / .I/.I.XT/.PTP/.I.PTP	2048
VCXG-53C / .I/.I.XT	2048
VCXG-65C.R	2048
VCXG-82C / .I/.I.XT	2832
VCXG-91C	2160
VCXG-124C / .I/.I.XT/.PTP/.I.PTP	3000
VCXG-125C.R	3000
VCXG-127C / .I/.I.XT	2992
VCXG-201C.R.I/.I.XT	3648
VCXG-204C	4496
VCXG-241C / .I/.I.XT	4592

### 7.11.10.2 VCXU

Camera Type	Values
<b>Monochrome</b>	
VCXU-02M	480
VCXU-04M	540
VCXU-13M	1024
VCXU-15M	1080
VCXU-22M.R	1080
VCXU-23M	1200
VCXU-24M	1200
VCXU-25M	1200
VCXU-31M	1536
VCXU-32M	1536
VCXU-50M	2048
VCXU-50MP	2048
VCXU-51M	2048
VCXU-53M	2048
VCXU-65M.R	2048
VCXU-90M	2160
VCXU-91M	2160
VCXU-123M	3000
VCXU-124M	3000
VCXU-125M.R	3000
VCXU-201M.R	3648

Camera Type	Values
<b>Color</b>	
VCXU-02C	480
VCXU-04C	540
VCXU-13C	1024
VCXU-15C	1080
VCXU-22C.R	1080
VCXU-23C	1200
VCXU-24C	1200
VCXU-25C	1200
VCXU-31C	1536
VCXU-32C	1536
VCXU-50C	2048
VCXU-51C	2048
VCXU-53C	2048
VCXU-65C.R	2048
VCXU-90C	2160
VCXU-91C	2160
VCXU-123C	3000
VCXU-124C	3000
VCXU-125C.R	3000
VCXU-201C.R	3648
VCXU-201M.R	3648

### 7.11.11 OffsetX

Horizontal offset from the origin to the region of interest (in pixels).

#### Notice

The sum of *OffsetX* and *WidthMax* must be smaller or equal than *WidthMax*.

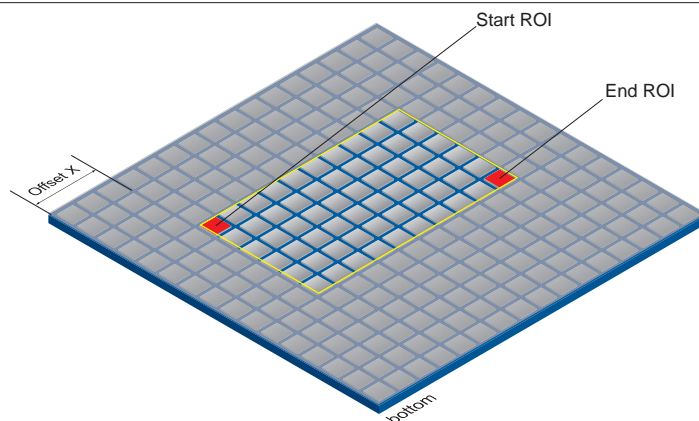

<b>Name</b>	OffsetX
<b>Category</b>	ImageFormatControl
<b>Interface</b>	Integer
<b>Access</b>	Read / Write
<b>Unit</b>	-
<b>Values</b>	0 - depends on <i>Width</i>

### 7.11.12 OffsetY

Vertical offset from the origin to the region of interest (in pixels).

#### Notice

The sum of *OffsetY* and *Height* must be smaller or equal than *HeightMax*.

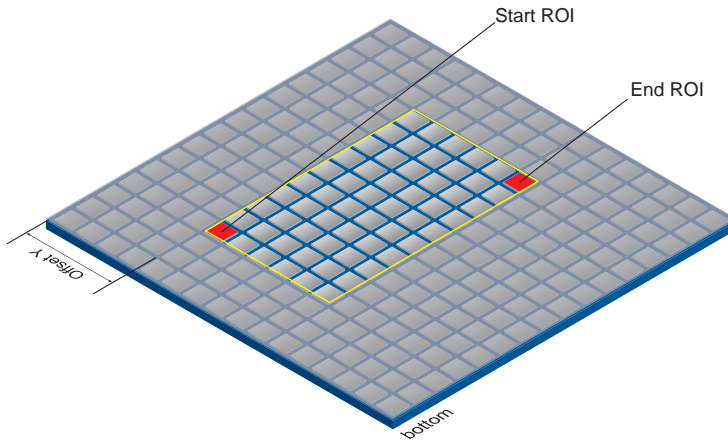

<b>Name</b>	OffsetY
<b>Category</b>	ImageFormatControl
<b>Interface</b>	Integer
<b>Access</b>	Read / Write
<b>Unit</b>	-
<b>Values</b>	0 - depends on <i>Height</i>

### 7.11.13 PixelFormat

Format of the pixels provided by the device. It represents all the information provided by PixelCoding, PixelSize, PixelColorFilter combined in a single feature.

#### General Information

**RAW:** Raw data format. Here the data are stored without processing.

**Bayer:** Raw data format of color sensors.

Color filters are placed on these sensors in a checkerboard pattern, generally in a 50% green, 25% red and 25% blue array.

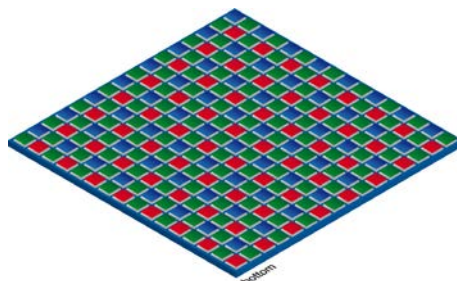

**Mono:** Monochrome. The color range of mono images consists of shades of a single color. In general, shades of gray or black-and-white are synonyms for monochrome.

RGB: Color model, in which all detectable colors are defined by three coordinates, Red, Green and Blue.

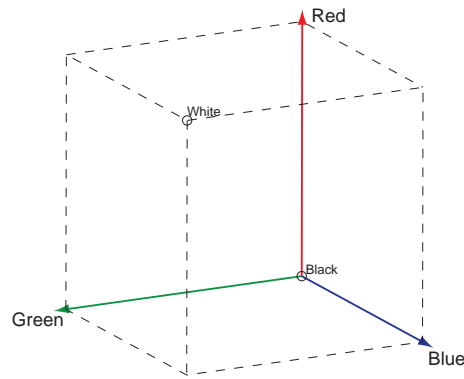

The three coordinates are displayed within the buffer in the order R, G, B.

BGR: At BGR the interface of the camera mirrors the order of transmission of the color channels from RGB to BGR.

This can save processing power on the computer, because these data can be processed by the graphic card without conversion.

Pixel depth: In general, pixel depth defines the number of possible different values for each color channel. Mostly this will be 8 bit, which means  $2^8$  different "colors".

For RGB or BGR these 8 bits per channel equal 24 bits overall.

Two bytes are needed for transmitting more than 8 bits per pixel - even if the second byte is not completely filled with data. In order to save bandwidth, the packed formats were introduced to Baumer CX cameras. In this formats, the unused bits of one pixel are filled with data from the next pixel.

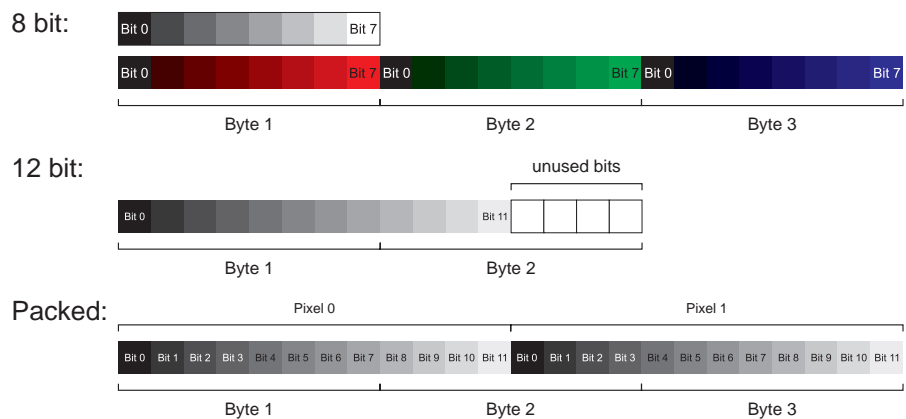

#### Notice

The camera must be stopped before *PixelFormat* can be set.

<b>Name</b>	PixelFormat
<b>Category</b>	ImageFormatControl
<b>Interface</b>	IEnumeration
<b>Access</b>	Read / Write
<b>Unit</b>	-
<b>Values</b>	see tables below



7.11.13.1 VCXG / .XC/ .I/ .I.XT / .PTP / .I.PTP

Camera Type	Mono8	Mono10	Mono12	Mono12p	Bayer RG8	Bayer RG10	Bayer RG12	Bayer G12p	RGB8	BGR8
<b>Monochrome</b>										
VCXG-02M	■	■	□	□	□	□	□	□	□	□
VCXG-04M	■	■	■	■	□	□	□	□	□	□
VCXG-13M / .I/.I.XT	■	■	□	□	□	□	□	□	□	□
VCXG-13NIR	■	□	□	□	□	□	□	□	□	□
VCXG-14SWIR.XC	■	■	■	■	□	□	□	□	□	□
VCXG-15M / .I/.I.XT	■	■	■	■	□	□	□	□	□	□
VCXG-22M.R	■	■	■	■	□	□	□	□	□	□
VCXG-23M	■	■	■	■	□	□	□	□	□	□
VCXG-24M	■	■	■	■	□	□	□	□	□	□
VCXG-25M / .I/.I.XT	■	■	□	□	□	□	□	□	□	□
VCXG-32M / .I/.I.XT/.PTP/.I.PTP	■	■	■	■	□	□	□	□	□	□
VCXG-50MP	■	■	■	■	□	□	□	□	□	□
VCXG-51M/.XC/.I/.I.XT.PTP/.I.PTP	■	■	■	■	□	□	□	□	□	□
VCXG-53M / .I/.I.XT	■	■	□	□	□	□	□	□	□	□
VCXG-53NIR	■	□	□	□	□	□	□	□	□	□
VCXG-65M.R	■	■	■	■	□	□	□	□	□	□
VCXG-82M / .I/.I.XT	■	■	□	□	□	□	□	□	□	□
VCXG-91M	■	■	■	■	□	□	□	□	□	□
VCXG-124M / .I/.I.XT.PTP/.I.PTP	■	■	■	■	□	□	□	□	□	□
VCXG-125M.R	■	■	■	■	□	□	□	□	□	□
VCXG-127M / .I/.I.XT	■	■	■	■	□	□	□	□	□	□
VCXG-201M.R / .I/.I.XT	■	■	■	■	□	□	□	□	□	□
VCXG-204M	■	■	■	■	□	□	□	□	□	□
VCXG-241M / .I/.I.XT	■	■	■	■	□	□	□	□	□	□

**Notice**

**VCXU-201M.R (Rel. 4)**  
**VCXG-201C.R (Rel. 4)**

In pixel formats:

- Mono8
- Mono10
- Bayer RG8
- Bayer RG10

and Region of Interest (ROI) (*Height* 1649 ... 3648) vertical partial scan will be done in the sensor.

This leads to an increase of the frame rate.

The other area (*Height* 1 ... 1648) is done in the FPGA and the frame rate does not increase.

In the other pixel formats, partial scan is done only in the FPGA and the frame rate does not increase either.

Camera Type	Mono8	Mono10	Mono12	Mono12p	Bayer RG8	Bayer RG10	Bayer RG12	Bayer RG12p	RGB8	BGR8
<b>Color</b>										
VCXG-02C	■	■	□	□	■	■	□	□	■	■
VCXG-04C	■	■	■	■	■	■	■	■	■	■
VCXG-13C / .I/.I.XT	■	■	□	□	■	■	□	□	■	■
VCXG-15C / .I/.I.XT	■	■	■	■	■	■	■	■	■	■
VCXG-22C.R	■	■	■	■	■	■	■	■	■	■
VCXG-23C	■	■	■	■	■	■	■	■	■	■
VCXG-24C	■	■	■	■	■	■	■	■	■	■
VCXG-25C / .I/.I.XT	■	■	□	□	■	■	□	□	■	■
VCXG-32C / .I/.I.XT/.PTP/.I.PTP	■	■	■	■	■	■	■	■	■	■
VCXG-51C / .I/.I.XT/.PTP/.I.PTP	■	■	■	■	■	■	■	■	■	■
VCXG-53C / .I/.I.XT	■	■	□	□	■	■	□	□	■	■
VCXG-65C.R	■	■	■	■	■	■	■	■	■	■
VCXG-82C / .I/.I.XT	■	■	■	■	■	■	■	■	■	■

VCXG-91C	■	■	■	■	■	■	■	■	■	■	■
VCXG-124C / .I/.I.XT/.PTP/.I.PTP	■	■	■	■	■	■	■	■	■	■	■
VCXG-125C.R	■	■	■	■	■	■	■	■	■	■	■
VCXG-127C / .I/.I.XT	■	■	■	■	■	■	■	■	■	■	■
VCXG-201C.R / .I/.I.XT	■	■	■	■	■	■	■	■	■	■	■
VCXG-204C	■	■	■	■	■	■	■	■	■	■	■
VCXG-241C / .I/.I.XT	■	■	■	■	■	■	■	■	■	■	■

### 7.11.13.2 VCXU

Camera Type	Mono8	Mono10	Mono12	Mono12p	Bayer RG8	Bayer RG10	Bayer RG12	Bayer RG12p	RGB8	BGR8
<b>Monochrome</b>										
VCXU-02M	■	■	■	■	□	□	□	□	□	□
VCXU-04M	■	■	■	■	□	□	□	□	□	□
VCXU-13M	■	■	□	□	□	□	□	□	□	□
VCXU-15M	■	■	■	■	□	□	□	□	□	□
VCXU-22M.R	■	■	■	■	□	□	□	□	□	□
VCXU-23M	■	■	■	■	□	□	□	□	□	□
VCXU-24M	■	■	■	■	□	□	□	□	□	□
VCXU-25M	■	■	□	□	□	□	□	□	□	□
VCXU-31M	■	■	■	■	□	□	□	□	□	□
VCXU-32M	■	■	■	■	□	□	□	□	□	□
VCXU-50M	■	■	■	■	□	□	□	□	□	□
VCXU-50MP	■	■	■	■	□	□	□	□	□	□
VCXU-51M	■	■	■	■	□	□	□	□	□	□
VCXU-53M	■	■	□	□	□	□	□	□	□	□
VCXU-65M.R	■	■	■	■	□	□	□	□	□	□
VCXU-90M	■	■	■	■	□	□	□	□	□	□
VCXU-91M	■	■	■	■	□	□	□	□	□	□
VCXU-123M	■	■	■	■	□	□	□	□	□	□
VCXU-124M	■	■	■	■	□	□	□	□	□	□
VCXU-125M.R	■	■	■	■	□	□	□	□	□	□
VCXU-201M.R	■	■	■	■	□	□	□	□	□	□

Camera Type	Mono8	Mono10	Mono12	Mono12p	Bayer RG8	Bayer RG10	Bayer RG12	Bayer RG12p	RGB8	BGR8
<b>Color</b>										
VCXU-02C	■	■	□	□	■	■	□	□	■	■
VCXU-04C	■	■	■	■	■	■	■	■	■	■
VCXU-13C	■	■	□	□	■	■	□	□	■	■
VCXU-15C	■	■	■	■	■	■	■	■	■	■
VCXU-22C.R	■	■	■	■	■	■	■	■	■	■
VCXU-23C	■	■	■	■	■	■	■	■	■	■
VCXU-24C	■	■	■	■	■	■	■	■	■	■
VCXU-25C	■	■	□	□	■	■	□	□	■	■

VCXU-31C	■	■	■	■	■	■	■	■	■	■	■
VCXU-32C	■	■	■	■	■	■	■	■	■	■	■
VCXU-50C	■	■	■	■	■	■	■	■	■	■	■
VCXU-51C	■	■	■	■	■	■	■	■	■	■	■
VCXU-53C	■	■	□	□	■	■	□	□	■	■	■
VCXU-65C.R	■	■	■	■	■	■	■	■	■	■	■
VCXU-90C	■	■	■	■	■	■	■	■	■	■	■
VCXU-91C	■	■	■	■	■	■	■	■	■	■	■
VCXU-123C	■	■	■	■	■	■	■	■	■	■	■
VCXU-124C	■	■	■	■	■	■	■	■	■	■	■
VCXU-125C.R	■	■	■	■	■	■	■	■	■	■	■
VCXU-201C.R	■	■	■	■	■	■	■	■	■	■	■

### 7.11.14 ReverseX (mono cameras / pixel formats only)

Flip horizontally the image sent by the device. The Region of interest is applied before the flipping.

#### Notice

The camera must be stopped before this feature can be set.

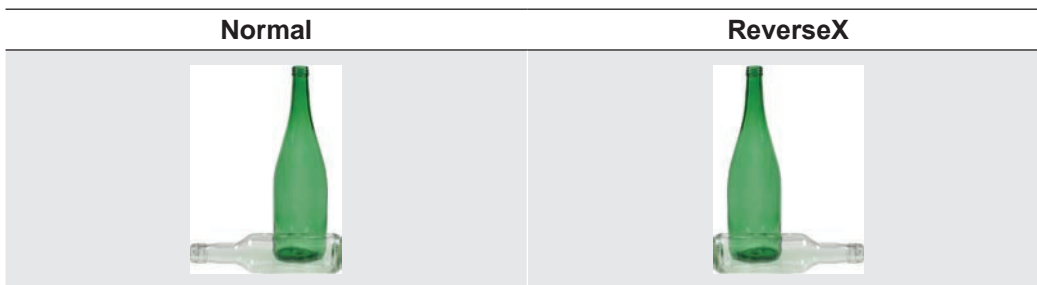

<b>Name</b>	ReverseX
<b>Category</b>	ImageFormatControl
<b>Interface</b>	IBoolean
<b>Access</b>	Read / Write
<b>Unit</b>	-
<b>Values</b>	true = 1 (On) false = 0 (Off)

### 7.11.15 ReverseY (monochrome cameras / pixel formats only)

Flip vertically the image sent by the device. The Region of interest is applied before the flipping.

#### Notice

The camera must be stopped before this feature can be set.

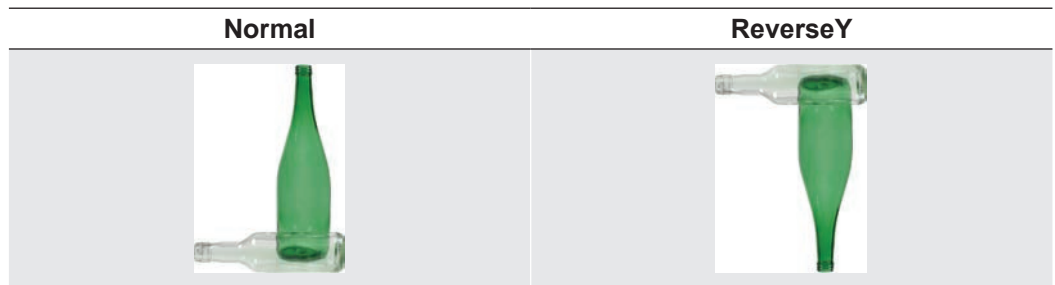

<b>Name</b>	ReverseY
<b>Category</b>	ImageFormatControl
<b>Interface</b>	IBoolean
<b>Access</b>	Read / Write
<b>Unit</b>	-
<b>Values</b>	true = 1 (On) false = 0 (Off)

### 7.11.16 SensorHeight

Effective height of the sensor in pixels.

<b>Name</b>	SensorHeight
<b>Category</b>	ImageFormatControl
<b>Interface</b>	IInteger
<b>Access</b>	Read only
<b>Unit</b>	-
<b>Values</b>	0 ... 65535 (Increment: 1)

### 7.11.17 SensorName (≥ Release 3 only)

Product name of the imaging Sensor.

<b>Name</b>	SensorName
<b>Category</b>	ImageFormatControl
<b>Interface</b>	IString
<b>Access</b>	Read only
<b>Unit</b>	-
<b>Values</b>	e. g. IMX174

### 7.11.18 SensorPixelHeight (≥ Release 3 only)

Physical size (pitch) in the y direction of a photo sensitive pixel unit.

<b>Name</b>	SensorPixelHeight
<b>Category</b>	ImageFormatControl
<b>Interface</b>	IFloat
<b>Access</b>	Read only
<b>Unit</b>	um
<b>Values</b>	0.000000 ... 255.000000 (Increment: 1)

### 7.11.19 SensorPixelWidth (≥ Release 3 only)

Physical size (pitch) in the x direction of a photo sensitive pixel unit.

<b>Name</b>	SensorPixelWidth
<b>Category</b>	ImageFormatControl
<b>Interface</b>	IFloat
<b>Access</b>	Read only
<b>Unit</b>	um
<b>Values</b>	0.000000 ... 255.000000 (Increment: 1)

### 7.11.20 SensorShutterMode

Sets the sensor shutter mode of the camera. The sensor shutter mode depends on the Trigger Mode.

<b>Name</b>	SensorShutterMode	
<b>Category</b>	ImageFormatControl	
<b>Interface</b>	IEnumeration	
<b>Access</b>	Read / Write	
<b>Unit</b>	-	
<b>Values</b>	GlobalReset	The shutter opens at the same time for all pixels but ends in a sequential manner. The pixels are exposed for different lengths of time.
	Rolling	The shutter opens and closes sequentially for groups (typically lines) of pixels. All the pixels are exposed for the same length of time but not at the same time.
	Global	The shutter opens and closes at the same time for all pixels. All the pixels are exposed for the same length of time at the same time.

#### V CXG / V CXU (only cameras with rolling shutter sensors)

Camera Type (Sensor)	Trigger Mode = On		Trigger Mode = Off	
	Shutter Mode	Readout Mode	Shutter Mode	Readout Mode
<b>Monochrome / Color</b>				
VCXG-22M.R	Global Reset	Non-overlapped	Global Reset	Non-overlapped
VCXG-22C.R	Rolling	Non-overlapped	Rolling	Overlapped
VCXU-22M.R	Global Reset	Non-overlapped	Global Reset	Non-overlapped
VCXU-22C.R	Rolling	Non-overlapped	Rolling	Overlapped
VCXG-65M.R	Global Reset	Non-overlapped	Global Reset	Non-overlapped
VCXG-65C.R	Rolling	Non-overlapped	Rolling	Overlapped
VCXU-65M.R	Global Reset	Non-overlapped	Global Reset	Non-overlapped
VCXU-65C.R	Rolling	Non-overlapped	Rolling	Overlapped
VCXG-201M.R / .I/.I.XT	Global Reset	Non-overlapped	Global Reset	Non-overlapped
VCXG-201C.R / .I/.I.XT	Rolling	Non-overlapped	Rolling	Overlapped
VCXG-125M.R	Global Reset	Non-overlapped	Global Reset	Non-overlapped
VCXG-125C.R	Rolling	Non-overlapped	Rolling	Overlapped
VCXU-125M.R	Global Reset	Non-overlapped	Global Reset	Non-overlapped
VCXU-125C.R	Rolling	Non-overlapped	Rolling	Overlapped
VCXU-201M.R	Global Reset	Non-overlapped	Global Reset	Non-overlapped
VCXU-201C.R	Rolling	Non-overlapped	Rolling	Overlapped

## Global Reset

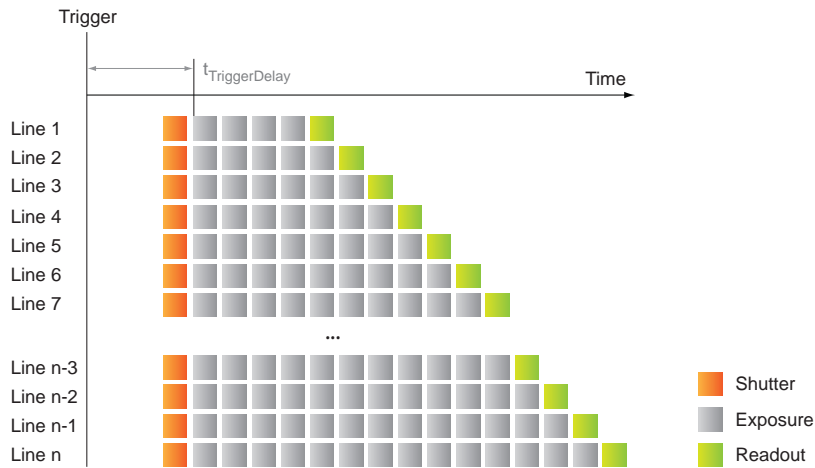

For cameras with rolling shutter sensor and set shutter mode Global Reset, for each frame all of the lines start exposure at the same time but the end of exposure is delayed by the offset of the previous line's readout. The exposure time for each line gradually lengthens. Data readout for each line begins immediately following the line's exposure. The readout time for each line is the same, but the start and end times are staggered.

An advantage of this shutter mode is a reduction in image artifacts typical of rolling shutters. However, because exposure lengthens throughout the frame, there may be a gradual increase in brightness from top to bottom of an image.

## Rolling Shutter

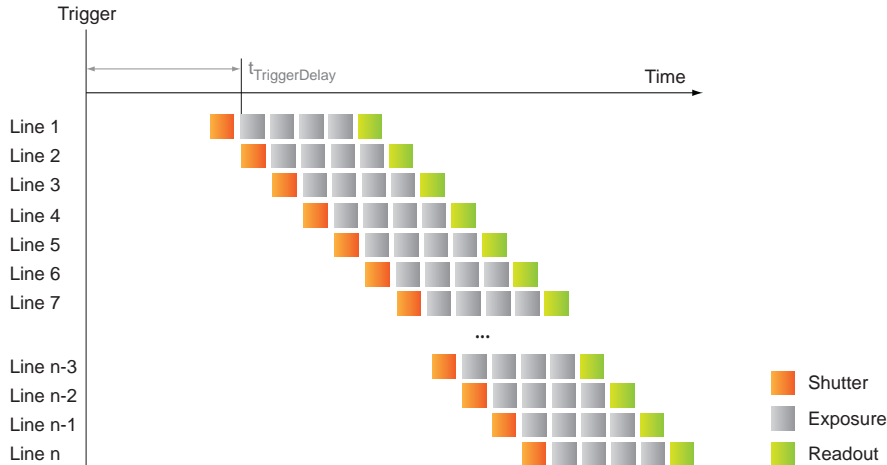

**Notice**

Due to technical issues of rolling shutter, a flash control depending on the exposure time does not make sense.

Such cameras should be used in a continuously illuminated environment.

For cameras with rolling shutter sensor and set shutter mode Rolling Shutter, for each frame each line begins exposure at an offset equal to each line's readout time. The exposure time for each line is the same, but the start and end times are staggered. Data readout for each line begins immediately following the line's exposure. The readout time for each line is the same, but the start and end times are staggered.

One advantage of a Rolling Shutter is increased sensitivity. However, because exposure starts at different times throughout the frame, there are known artifacts such as skew, wobble, and partial exposure.

### 7.11.21 SensorWidth

Effective width of the sensor in pixels.

<b>Name</b>	SensorWidth
<b>Category</b>	ImageFormatControl
<b>Interface</b>	IInteger
<b>Access</b>	Read only
<b>Unit</b>	-
<b>Values</b>	0 ... 65535 (Increment: 1)

### 7.11.22 TestPattern

Selects the type of test pattern that is generated by the device as image source.

<b>Name</b>	TestPattern
<b>Category</b>	ImageFormatControl
<b>Interface</b>	IEnumeration
<b>Access</b>	Read / Write
<b>Unit</b>	-
<b>Values</b>	see table below

GreyDiagonalRamp	Image is filled diagonally with an image that goes from the darkest possible value to the brightest.
GreyDiagonalRampHorizontalAndVerticalLineMoving	Image is filled diagonally with an image that goes from the darkest possible value to the brightest with moving horizontal and vertical lines.
GreyDiagonalRampHorizontalLineMoving	Image is filled diagonally with an image that goes from the darkest possible value to the brightest with moving horizontal lines.
GreyDiagonalRampVerticalLineMoving	Image is filled diagonally with an image that goes from the darkest possible value to the brightest with moving vertical lines.
GreyHorizontalRamp	Image is filled horizontally with an image that goes from the darkest possible value to the brightest.
GreyHorizontalRampHorizontalAndVerticalLineMoving	Image is filled horizontally with an image that goes from the darkest possible value to the brightest with moving horizontal and vertical lines.
GreyHorizontalRampHorizontalLineMoving	Image is filled horizontally with an image that goes from the darkest possible value to the brightest with moving horizontal lines.
GreyHorizontalRampVerticalLineMoving	Image is filled horizontally with an image that goes from the darkest possible value to the brightest with moving vertical lines.
GreyVerticalRamp	Image is filled vertically with an image that goes from the darkest possible value to the brightest.
GreyVerticalRampHorizontalAndVerticalLineMoving	Image is filled vertically with an image that goes from the darkest possible value to the brightest with moving horizontal and vertical lines.



GreyVerticalRampHorizontalLineMoving	Image is filled vertically with an image that goes from the darkest possible value to the brightest with moving horizontal lines.
GreyVerticalRampVerticalLineMoving	Image is filled vertically with an image that goes from the darkest possible value to the brightest with moving vertical lines.
HorizontalAndVerticalLineMoving	Image is filled with moving horizontal and vertical lines.
HorizontalLineMoving	Image is filled with moving horizontal lines.
Off	Image is coming from the sensor.
VerticalLineMoving	Image is filled with moving vertical lines.

### 7.11.23 TestPatternGeneratorSelector

Selects which test pattern generator is controlled by the *TestPattern* feature.

<b>Name</b>	TestPatternGeneratorSelector	
<b>Category</b>	ImageFormatControl	
<b>Interface</b>	IEnumeration	
<b>Access</b>	Read / Write	
<b>Unit</b>	-	
<b>Values</b>	ImageProcessor	TestPattern feature will control the image processor.
	Sensor Processor	TestPattern feature will control the sensor processor.

### 7.11.24 Width

Width of the image provided by the device (in pixels).

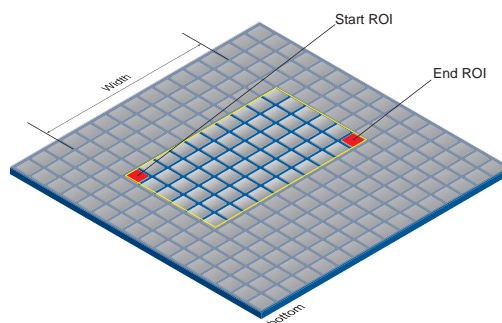

<b>Name</b>	Width
<b>Category</b>	ImageFormatControl
<b>Interface</b>	IInteger
<b>Access</b>	Read / Write
<b>Unit</b>	-
<b>Values</b>	see tables below

### 7.11.24.1 VCXG / .XC / .I / .I.XT / .PTP / .I.PTP

Camera Type	Values
<b>Monochrome</b>	
VCXG-02M	24 ... 640 (Increment: 8)
VCXG-04M	16 ... 720 (Increment: 16)
VCXG-13M / .I/.I.XT	24 ... 1280 (Increment: 8)
VCXG-13NIR	24 ... 1280 (Increment: 8)
VCXG-14SWIR.XC	16 ... 1296 (Increment: 16)
VCXG-15M / .I/.I.XT	16 ... 1440 (Increment: 32)
VCXG-22M.R	16 ... 1920 (Increment: 16)
VCXG-23M	16 ... 1920 (Increment: 16)
VCXG-24M	16 ... 1920 (Increment: 16)
VCXG-25M / .I/.I.XT	48 ... 1920 (Increment: 16)
VCXG-32M / .I/.I.XT/.PTP/.I.PTP	16 ... 2048 (Increment: 16)
VCXG-50MP	16 ... 2448 (Increment: 16)
VCXG-51M / .XC/.I/.I.XT/.PTP/.I.PTP	16 ... 2448 (Increment: 16)
VCXG-53M / .I/.I.XT	48 ... 2592 (Increment: 16)
VCXG-53NIR	48 ... 2592 (Increment: 16)
VCXG-65M.R	16 ... 3072 (Increment: 16)
VCXG-82M / .I/.I.XT	32 ... 2848 (Increment: 32)
VCXG-91M	16 ... 4096 (Increment: 16)
VCXG-124M / .I/.I.XT/.PTP/.I.PTP	16 ... 4096 (Increment: 16)
VCXG-125M.R	16 ... 4000 (Increment: 16)
VCXG-127M / .I/.I.XT	32 ... 4096 (Increment: 32)
VCXG-201M.R / .I/.I.XT	32 ... 5472 (Increment: 32)
VCXG-204M	32 ... 4480 (Increment: 32)
VCXG-241M / .I/.I.XT	32 ... 5312 (Increment: 32)
<b>Color</b>	
VCXG-02C	24 ... 640 (Increment: 8)
VCXG-04C	16 ... 720 (Increment: 16)
VCXG-13C / .I/.I.XT	24 ... 1280 (Increment: 8)
VCXG-15C / .I/.I.XT	16 ... 1440 (Increment: 32)
VCXG-22C.R	16 ... 1920 (Increment: 16)
VCXG-23C	16 ... 1920 (Increment: 16)
VCXG-24C	16 ... 1920 (Increment: 16)
VCXG-25C / .I/.I.XT	48 ... 1920 (Increment: 16)
VCXG-32C / .I/.I.XT/.PTP/.I.PTP	16 ... 2048 (Increment: 16)
VCXG-51C / .I/.I.XT/.PTP/.I.PTP	16 ... 2448 (Increment: 16)
VCXG-53C / .I/.I.XT	48 ... 2592 (Increment: 16)
VCXG-65C.R	16 ... 3072 (Increment: 16)
VCXG-82C / .I/.I.XT	32 ... 2848 (Increment: 32)
VCXG-91C	16 ... 4096 (Increment: 16)
VCXG-124C / .I/.I.XT/.PTP/.I.PTP	16 ... 4096 (Increment: 16)
VCXG-125C.R	16 ... 4000 (Increment: 16)
VCXG-127C / .I/.I.XT	32 ... 4096 (Increment: 32)
VCXG-201C.R / .I/.I.XT	32 ... 5472 (Increment: 32)
VCXG-204C	32 ... 4480 (Increment: 32)
VCXG-241C / .I/.I.XT	32 ... 5312 (Increment: 32)

## 7.11.24.2 VCXU

Camera Type	Values
<b>Monochrome</b>	
VCXU-02M	24 / 32* ... 640 (Increment: 8 / 16*)
VCXU-04M	16 ... 720 (Increment: 16)
VCXU-13M	24 / 32* ... 1280 (Increment: 8 / 16*)
VCXU-15M	16 ... 1440 (Increment: 32)
VCXU-22M.R	16 ... 1920 (Increment: 16)
VCXU-23M	16 ... 1920 (Increment: 16)
VCXU-24M	16 ... 1920 (Increment: 16)
VCXU-25M	48 ... 1920 (Increment: 16)
VCXU-31M	16 ... 2048 (Increment: 16)
VCXU-32M	16 ... 2048 (Increment: 16)
VCXU-50M	16 ... 2448 (Increment: 16)
VCXU-50MP	16 ... 2448 (Increment: 16)
VCXU-51M	16 ... 2448 (Increment: 16)
VCXU-53M	48 ... 2592 (Increment: 16)
VCXU-65M.R	16 ... 3072 (Increment: 16)
VCXU-90M	16 ... 4096 (Increment: 16)
VCXU-91M	16 ... 4096 (Increment: 16)
VCXU-123M	16 ... 4096 (Increment: 16)
VCXU-124M	16 ... 4096 (Increment: 16)
VCXU-125M.R	16 ... 4000 (Increment: 16)
VCXU-201M.R	16 ... 5472 (Increment: 16)
<b>Color</b>	
VCXU-02C	24 / 32* ... 640 (Increment: 8 / 16*)
VCXU-04C	16 ... 720 (Increment: 16)
VCXU-13C	24 / 32* ... 1280 (Increment: 8 / 16*)
VCXU-15C	16 ... 1440 (Increment: 32)
VCXU-22C.R	16 ... 1920 (Increment: 16)
VCXU-23C	16 ... 1920 (Increment: 16)
VCXU-24C	16 ... 1920 (Increment: 16)
VCXU-25C	48 ... 1920 (Increment: 16)
VCXU-31C	16 ... 2048 (Increment: 16)
VCXU-32C	16 ... 2048 (Increment: 16)
VCXU-50C	16 ... 2448 (Increment: 16)
VCXU-51C	16 ... 2448 (Increment: 16)
VCXU-53C	48 ... 2592 (Increment: 16)
VCXU-65C.R	16 ... 3072 (Increment: 16)
VCXU-90C	16 ... 4096 (Increment: 16)
VCXU-91C	16 ... 4096 (Increment: 16)
VCXU-123C	16 ... 4096 (Increment: 16)
VCXU-124C	16 ... 4096 (Increment: 16)
VCXU-125C.R	16 ... 4000 (Increment: 16)
VCXU-201C.R	16 ... 5472 (Increment: 16)

\*) ≥ Release 3

### 7.11.25 WidthMax

Maximum width of the image (in pixels). The dimension is calculated after horizontal binning, decimation or any other function changing the horizontal dimension of the image.

<b>Name</b>	WidthMax
<b>Category</b>	ImageFormatControl
<b>Interface</b>	Integer
<b>Access</b>	Read only
<b>Unit</b>	-
<b>Values</b>	Resolution of the sensor in X-direction. (see tables below)

#### 7.11.25.1 VCXG /.XC / .I / .I.XT / .PTP / .I.PTP

Camera Type	Values
<b>Monochrome</b>	
VCXG-02M	640
VCXG-04M	720
VCXG-13M / .I/.I.XT	1280
VCXG-13NIR	1280
VCXG-14SWIR.XC	1296
VCXG-15M / .I/.I.XT	1440
VCXG-22M.R	1920
VCXG-23M	1920
VCXG-24M	1920
VCXG-25M / .I/.I.XT	1920
VCXG-32M / .I/.I.XT/.PTP/.I.PTP	2048
VCXG-50MP	2448
VCXG-51M/.XC.I/.I.XT/.PTP/.I.PTP	2448
VCXG-53M / .I/.I.XT	2592
VCXG-53NIR	2592
VCXG-65M.R	3072
VCXG-82M / .I/.I.XT	2848
VCXG-91M	4096
VCXG-124M / .I/.I.XT/.PTP/.I.PTP	4096
VCXG-125M.R	4000
VCXG-127M / .I/.I.XT	4096
VCXG-201M.R / .I/.I.XT	5472
VCXG-204M	4480
VCXG-241M / .I/.I.XT	5312

Camera Type	Values
<b>Color</b>	
VCXG-02C	640
VCXG-04C	720
VCXG-13C / .I/.I.XT	1280
VCXG-15C / .I/.I.XT	1440
VCXG-22C.R	1920
VCXG-23C	1920
VCXG-24C	1920
VCXG-25C / .I/.I.XT	1920
VCXG-32C / .I/.I.XT/.PTP/.I.PTP	2048
VCXG-51C / .I/.I.XT/.PTP/.I.PTP	2448
VCXG-53C / .I/.I.XT	2592
VCXG-65C.R	3072
VCXG-82C / .I/.I.XT	2848
VCXG-91C	4096
VCXG-124C / .I/.I.XT/.PTP/.I.PTP	4096
VCXG-125C.R	4000
VCXG-127C / .I/.I.XT	4096
VCXG-201C.R / .I/.I.XT	5472
VCXG-204C	4480
VCXG-241C / .I/.I.XT	5312

### 7.11.25.2 VCXU

Camera Type	Values
<b>Monochrome</b>	
VCXU-02M	640
VCXU-04M	720
VCXU-13M	1280
VCXU-15M	1440
VCXU-22M.R	1920
VCXU-23M	1920
VCXU-24M	1920
VCXU-25M	1920
VCXU-31M	2048
VCXU-32M	2048
VCXU-50M	2448
VCXU-50MP	2448
VCXU-51M	2448
VCXU-53M	2592
VCXU-65M.R	3072
VCXU-90M	4096
VCXU-91M	4096
VCXU-123M	4096
VCXU-124M	4096
VCXU-125M.R	4000
VCXU-201M.R	5472

Camera Type	Values
<b>Color</b>	
VCXU-02C	640
VCXU-04C	720
VCXU-13C	1280
VCXU-15C	1440
VCXU-22C.R	1920
VCXU-23C	1920
VCXU-24C	1920
VCXU-25C	1920
VCXU-31C	2048
VCXU-32C	2048
VCXU-50C	2448
VCXU-51C	2448
VCXU-53C	2592
VCXU-65C.R	3072
VCXU-90C	4096
VCXU-91C	4096
VCXU-123C	4096
VCXU-124C	4096
VCXU-125C.R	4000
VCXU-201C.R	5472

## 7.12 Category: LUTControl

Features in this chapter describe the Look-up table (LUT) related features. For LUT related features, certain values are stored in the camera. This includes the coordinates of defective pixels so that they can be corrected.

### General information (Pixel Correction)

There is a certain probability of abnormal pixels – so-called defect pixels – occurring within sensors from all manufacturers. The charge quantity of these pixels is not linearly dependent on the exposure time.

The occurrence of these defect pixels is unavoidable and intrinsic to the manufacturing and aging process of the sensors.

The operation of the camera is not affected by these pixels. They only appear as brighter (warm pixel) or darker (cold pixel) spots on the recorded image.

Distinction of "hot" and "cold" pixels within the recorded image.

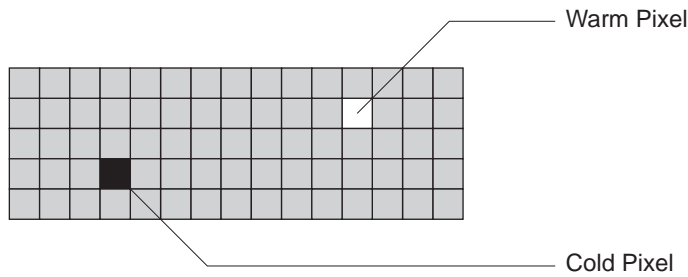

Charge quantity of "hot" and "cold" pixels compared with "normal" pixels:

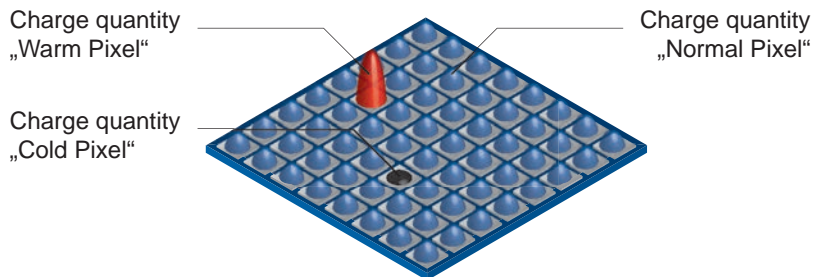

## Correction Algorithm (Pixel Correction)

On Baumer cameras the problem of defect pixels is solved as follows:

- Possible defect pixels are identified during the production process of the camera.
- The coordinates of these pixels are stored in the factory settings of the camera.
- Once the sensor readout is completed, correction takes place:
  - Before any other processing, the values of the neighboring pixels on the left and the right side of the defect pixels, will be read out. (within the same bayer phase for color)
  - Then the average value of these 2 pixels is determined to correct the first defect pixel
  - Finally, the value of the defect pixel is corrected by using the previously corrected pixel and the pixel of the other side of the defect pixel.

## Examples for the correction of defect pixels

- defect pixel
- corrected pixel (red)
- corrected pixel (green)

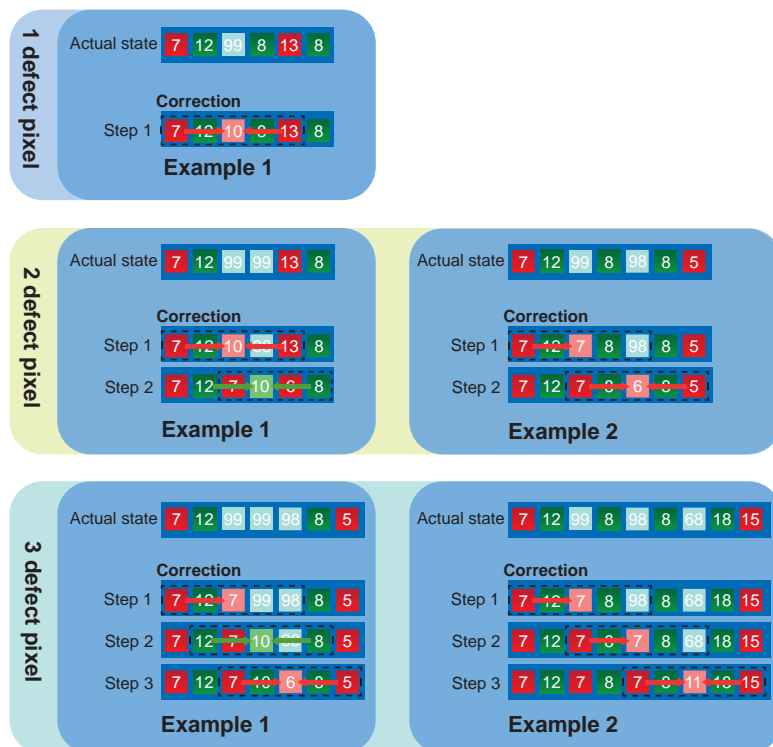

## General Information (Defect Pixel List)

As stated previously, this list is determined during the camera's production and stored in the factory settings.

Additional hot or cold pixels can develop during the lifecycle of a camera. If this happens, Baumer gives you the option to add their coordinates to the defect pixel list.

You can determine the coordinates<sup>1)</sup> of the affected pixels and add them to the list. Once the defect pixel list is stored in a user set, pixel correction is carried out for all coordinates on the defect pixel list.

### Notice

There are defect pixels, which occur only under certain environmental parameters. These include temperatures or exposure settings.

Complete defect pixels that occur in your application.

1) Position in relation to full frame format (raw data format)



## Add Defect Pixel to Defect Pixel List with Baumer Camera Explorer

### Notice

The addition of defect pixels must be done in FullFrame (without *Binning*, without *Width / Height / OffsetX / OffsetY*), in raw data format and without activated color calculation.

1. Start the *Camera Explorer*. Connect to the camera. Select the profile *GenICam Guru*.
2. Open the category *LUT Control*.
3. Locate an empty *Defect Pixel List Index*.  
*Defect Pixel List Entry PosX = 0*  
*Defect Pixel List Entry PosY = 0*  
Avoid using existing coordinates!
4. Determine the coordinates of the defect pixel. Keep the mouse pointer over the defect pixel. The coordinates of the defect pixel is displayed in the status bar.  
For simplification, you can enlarge the image.
5. Enter the determined coordinates for X (*Defect Pixel List Entry PosX*) and Y (*Defect Pixel List Entry PosY*).
6. Activate the registered *Defect Pixel List Index* (*Defect Pixel List Entry Active = True*).
7. Stop the camera and start them again to take over the updated coordinates.

### 7.12.1 DefectPixelCorrection

Enable the correction of defect pixels.

<b>Name</b>	DefectPixelCorrection
<b>Category</b>	LUTControl
<b>Interface</b>	IBoolean
<b>Access</b>	Read / Write
<b>Unit</b>	-
<b>Values</b>	true = 1 (On) false = 0 (Off)

### 7.12.2 DefectPixelListEntryActive

Determines if the pixel correction is active for the selected entry.

<b>Name</b>	DefectPixelListEntryActive
<b>Category</b>	LUTControl
<b>Interface</b>	IBoolean
<b>Access</b>	Read / Write
<b>Unit</b>	-
<b>Values</b>	true = 1 (On) false = 0 (Off)

### 7.12.3 DefectPixelListEntryPosX

X position of the defect pixel.

<b>Name</b>	DefectPixelListEntryPosX
<b>Category</b>	LUTControl
<b>Interface</b>	Integer
<b>Access</b>	Read / Write
<b>Unit</b>	-
<b>Values</b>	0 ... Resolution of the sensor in X-direction. (Increment: 1)

### 7.12.4 DefectPixelListEntryPosY

Y position of the defect pixel.

<b>Name</b>	DefectPixelListEntryPosY
<b>Category</b>	LUTControl
<b>Interface</b>	Integer
<b>Access</b>	Read / Write
<b>Unit</b>	-
<b>Values</b>	0 ... Resolution of the sensor in Y-direction. (Increment: 1)

### 7.12.5 DefectPixelListIndex

Index to the pixel correction list.

<b>Name</b>	DefectPixelListIndex
<b>Category</b>	LUTControl
<b>Interface</b>	Integer
<b>Access</b>	Read / Write
<b>Unit</b>	-
<b>Values</b>	0 ... 511 (Increment: 1)

### 7.12.6 DefectPixelListSelector

Selects which Defect Pixel List to control.

<b>Name</b>	DefectPixelListSelector
<b>Category</b>	LUTControl
<b>Interface</b>	Enumeration
<b>Access</b>	Read / Write
<b>Unit</b>	-
<b>Values</b>	Pixel          Selects Defect Pixel List for defect pixels.

### 7.12.7 Fixed Pattern Noise Correction (FPNC)

CMOS sensors exhibit nonuniformities that are called *Fixed Pattern Noise* (FPN). However it is no noise but a fixed variation from pixel to pixel that can be corrected. The advantage of using this correction is a more homogeneous picture which may simplify the image analysis. Variations from pixel to pixel of the dark signal are called dark signal nonuniformity (DSNU) whereas photo response nonuniformity (PRNU) describes variations of the sensitivity. DSNU is corrected via an offset while PRNU is corrected by a factor.

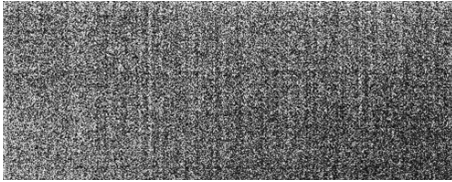

FPN Correction Off

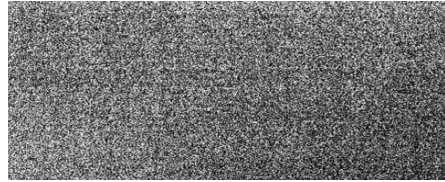

FPN Correction On

<b>Name</b>	Fixed Pattern Noise Correction
<b>Category</b>	LUTControl
<b>Interface</b>	IBoolean
<b>Access</b>	Read / Write
<b>Unit</b>	-
<b>Values</b>	true = 1 (On) false = 0 (Off)

#### 7.12.7.1 VCXG /.XC / .I / .I.XT / .PTP / .I.PTP

##### Notice

On cameras with Sony sensors additional FPN correction is not necessary.

Camera Type	FPNC
<b>Monochrome</b>	
VCXG-02M	<input checked="" type="checkbox"/>
VCXG-04M	<input type="checkbox"/>
VCXG-13M / .I/.I.XT	<input checked="" type="checkbox"/>
VCXG-13NIR	<input checked="" type="checkbox"/>
VCXG-14SWIR.XC	<input type="checkbox"/>
VCXG-15M / .I/.I.XT	<input type="checkbox"/>
VCXG-22M.R	<input type="checkbox"/>
VCXG-23M	<input type="checkbox"/>
VCXG-24M	<input type="checkbox"/>
VCXG-25M / .I/.I.XT	<input checked="" type="checkbox"/>
VCXG-32M / .I/.I.XT/.PTP/.I.PTP	<input type="checkbox"/>
VCXG-50MP	<input type="checkbox"/>
VCXG-51M /.XC / .I/.I.XT/.PTP/.I.PTP	<input type="checkbox"/>
VCXG-53M / .I/.I.XT	<input checked="" type="checkbox"/>
VCXG-53NIR	<input checked="" type="checkbox"/>
VCXG-65M.R	<input type="checkbox"/>
VCXG-82M / .I/.I.XT	<input type="checkbox"/>
VCXG-91M	<input type="checkbox"/>
VCXG-124M / .I/.I.XT/.PTP/.I.PTP	<input type="checkbox"/>
VCXG-127M / .I/.I.XT	<input type="checkbox"/>
VCXG-125M.R	<input type="checkbox"/>
VCXG-204M	<input type="checkbox"/>
VCXG-201M.R / .I/.I.XT	<input type="checkbox"/>
VCXG-241M / .I/.I.XT	<input type="checkbox"/>

Camera Type	FPNC
<b>Color</b>	
VCXG-02C	■
VCXG-04C	□
VCXG-13C / .I/.I.XT	■
VCXG-15C / .I/.I.XT	□
VCXG-22C.R	□
VCXG-23C	□
VCXG-24C	□
VCXG-25C / .I/.I.XT	■
VCXG-32C / .I/.I.XT/.PTP/.I.PTP	□
VCXG-51C / .I/.I.XT/.PTP/.I.PTP	□
VCXG-53C / .I/.I.XT	■
VCXG-65C.R	□
VCXG-82C / .I/.I.XT	□
VCXG-91C	□
VCXG-124C / .I/.I.XT/.PTP/.I.PTP	□
VCXG-125C.R	□
VCXG-127C / .I/.I.XT	□
VCXG-201C.R / .I/.I.XT	□
VCXG-204C	□
VCXG-241C / .I/.I.XT	□

### 7.12.7.2 VCXU

#### Notice

On cameras with Sony sensors additional FPN correction is not necessary.

Camera Type	FPNC
<b>Monochrome / Color</b>	
VCXU-02M / VCXU-02C	■
VCXU-04M / VCXU-04C	□
VCXU-13M / VCXU-13C	■
VCXU-15M / VCXU-15C	□
VCXU-22M.R / VCXU-22C.R	□
VCXU-23M / VCXU-23C	□
VCXU-24M / VCXU-24C	□
VCXU-25M / VCXU-25C	■
VCXU-31M / VCXU-31C	□
VCXU-32M / VCXU-32C	□
VCXU-50MP	□
VCXU-50M / VCXU-50C	□
VCXU-51M / VCXU-51C	□
VCXU-53M / VCXU-53C	■
VCXU-65M.R / VCXU-65C.R	□
VCXU-90M / VCXU-90C	□
VCXU-91M / VCXU-91C	□
VCXU-123M / VCXU-123C	□
VCXU-124M / VCXU-124C	□
VCXU-125M.R / VCXU-125C.R	□
VCXU-201M.R / VCXU-201C.R	□

### 7.12.8 LUTContent

Describes the content of the selected LUT.

<b>Name</b>	LUTContent	
<b>Category</b>	LUTControl	
<b>Interface</b>	IEnumeration	
<b>Access</b>	Read / Write	
<b>Unit</b>	-	
<b>Values</b>	Gamma	The content of the selected LUT is defined by the value of the feature Gamma.
	Userdefined LUT	The content of the selected LUT is user defined.

### 7.12.9 LUTEnable

Activates the selected The Look-Up-Table (LUT) The LUT is employed on Baumer mono-chrome and color cameras. It contains  $2^{12}$  (4096) values for the available levels. These values can be adjusted by the user.

For color cameras the LUT is applied for all color channels together.

<b>Name</b>	LUTEnable	
<b>Category</b>	LUTControl	
<b>Interface</b>	IBoolean	
<b>Access</b>	Read / Write	
<b>Unit</b>	-	
<b>Values</b>	true = 1 (On)	
	false = 0 (Off)	

### 7.12.10 LUTIndex

Control the index (offset) of the coefficient to access in the selected LUT.

<b>Name</b>	DefectPixelListEntryPosX	
<b>Category</b>	LUTControl	
<b>Interface</b>	IInteger	
<b>Access</b>	Read / Write	
<b>Unit</b>	-	
<b>Values</b>	0 ... 4095 (Increment: 1)	

### 7.12.11 LUTSelector

Selects which LUT to control.

<b>Name</b>	LUTContent
<b>Category</b>	LUTControl
<b>Interface</b>	IEnumeration
<b>Access</b>	Read / Write
<b>Unit</b>	-
<b>Values</b>	Luminance    Selects the Luminance LUT.

### 7.12.12 LUTValue

Returns the Value at entry LUTIndex of the LUT selected by LUTSelector.

<b>Name</b>	LUTValue
<b>Category</b>	LUTControl
<b>Interface</b>	IInteger
<b>Access</b>	Read / Write
<b>Unit</b>	-
<b>Values</b>	0 ... 4095 (Increment: 1)

## 7.13 Category: MemoryManagement (≥ Rel. 3 only)

Category to support the cameras buffer management in memory.

### 7.13.1 MemoryMaxBlocks

Maximum count of disposal memory blocks.

<b>Name</b>	MemoryMaxBlocks
<b>Category</b>	MemoryManagement
<b>Interface</b>	IInteger
<b>Access</b>	Read only
<b>Unit</b>	-
<b>Values</b>	0 ... 4294967295 (Increment: 1)

## 7.14 Category: SequencerControl (≥ Rel. 2 only)

Category for the Sequencer Control features.

The Sequencer enables the possibility of image series recording including automated re-parameterization of the camera based on different events and signals. Therefore the desired camera settings for each step are stored in so called sequencer sets.

Stringing together a number of these sequencer sets results in a sequence. The connection of sequences is done by using different paths. Alongside the camera features the path related features are also part of a sequencer set.

### Sequencer sets

Sequencer sets combine camera features – comparable with a user set – and sequencer (set and path) related parameters.

Settings for several camera features such as:

- Exposure time
- Gain
- Region of Interest (OffsetX / OffsetY / Width / Height)
- User output
- Counter

can be controlled by the sequencer and thus stored to a sequencer set as well as information for the set switch-over via four different paths.

**Notice**

With the Feature *SequencerFeatureSelector* you can see all available features of a Sequencer Set.

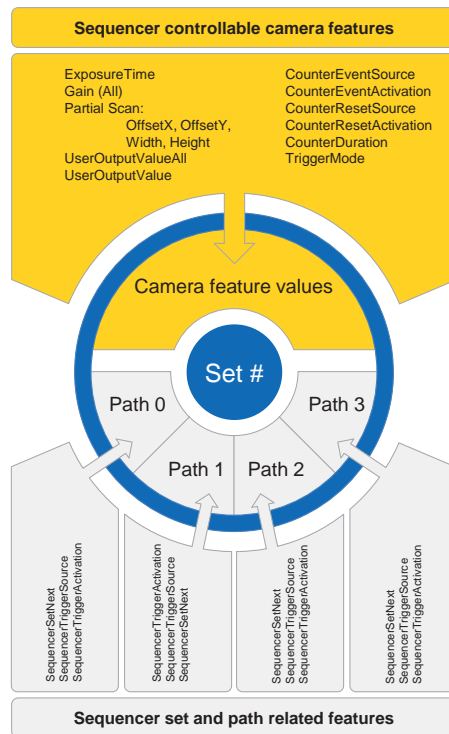

Each path involves:

- the destination for the set switch-over that is mapped by the SequencerSetNext feature
- the signal, whose change of state is used for triggering the set switch-over and that is mapped as SequencerTriggerSource
- the change of state triggering the set switch-over and that is mapped as 'Sequencer-TriggerActivation'

As with user sets the camera's current settings are overwritten once a sequencer set is loaded and the sequencer is activated.

## Sequencer configuration

In order to avoid overwriting current camera settings while configuring a sequencer, the camera needs to be set to the sequencer configuration mode.

Once the camera is set to the sequencer configuration mode, the individual sequencer sets can be selected via the SequencerSetSelector, configured and saved by executing SequencerSetSave.

Starting the configured sequence requires to switch the sequencer configuration mode off and to enable the sequencer mode.

### 7.14.1 SequencerConfigurationMode

Controls if the sequencer configuration mode is active.

<b>Name</b>	SequencerConfigurationMode	
<b>Category</b>	SequencerControl	
<b>Interface</b>	IEnumeration	
<b>Access</b>	Read / Write	
<b>Unit</b>	-	
<b>Values</b>	On	Enables the sequencer configuration mode.
	Off	Disables the sequencer configuration mode.

### 7.14.2 SequencerFeatureEnable

Enables the selected feature and make it active in all the sequencer sets.

<b>Name</b>	SequencerFeatureEnable	
<b>Category</b>	SequencerControl	
<b>Interface</b>	IBoolean	
<b>Access</b>	Read only	
<b>Unit</b>	-	
<b>Values</b>	true = 1 (On)	
	false = 0 (Off)	



### 7.14.3 SequencerFeatureSelector

Selects the camera features that are controlled by the sequencer.

<b>Name</b>	SequencerFeatureSelector	
<b>Category</b>	SequencerControl	
<b>Interface</b>	IEnumeration	
<b>Access</b>	Read / Write	
<b>Unit</b>	-	
<b>Values</b>	CounterDuration	Sets the duration (or number of events) before the CounterEnd event is generated.
	CounterEventActivation	Selects the Activation mode Event Source signal.
	CounterEventSource	Select the events that will be the source to increment the Counter.
	CounterResetActivation	Selects the Activation mode of the Counter Reset Source signal.
	CounterResetSource	Selects the signals that will be the source to reset the Counter.
	ExposureMode	Sets the operation mode of the Exposure (or shutter).
	ExposureTime	Returns the exposure time used to capture the image.
	Gain	Controls the selected gain as an absolute physical value.
	Height	Height of the image provided by the device (in pixels).
	OffsetX	Horizontal offset from the origin to the region of interest (in pixels).
	OffsetY	Vertical offset from the origin to the region of interest (in pixels).
	TriggerMode	Controls if the selected trigger is active.
	UserOutputValue	Sets the value of the bit selected by UserOutputSelector.
	UserOutputValueAll	Sets the value of all the bits of the User Output register.
	Width	Width of the image provided by the device (in pixels).

#### 7.14.4 SequencerMode

Controls if the sequencer mechanism is active.

##### Notice

To use this feature, the features *BalanceWhiteAuto* (color cameras only) and *SequencerConfigurationMode* must be off.

To write this feature, set `TLParamsLocked = 0`.

<b>Name</b>	SequencerMode
<b>Category</b>	SequencerControl
<b>Interface</b>	IEnumeration
<b>Access</b>	Read / Write
<b>Unit</b>	-
<b>Values</b>	On                    Enables the sequencer.
	Off                    Disables the sequencer.

#### 7.14.5 SequencerPathSelector

Selects the path that contains the settings coming afterward.

<b>Name</b>	SequencerPathSelector
<b>Category</b>	SequencerControl
<b>Interface</b>	IInteger
<b>Access</b>	Read / Write
<b>Unit</b>	-
<b>Values</b>	0 ... 3 (Increment: 1)

#### 7.14.6 SequencerSetActive

Contains the currently active sequencer set.

<b>Name</b>	SequencerSetActive
<b>Category</b>	SequencerControl
<b>Interface</b>	IInteger
<b>Access</b>	Read / Write
<b>Unit</b>	-
<b>Values</b>	0 ... 127 (Increment: 1)

### 7.14.7 SequencerSetLoad

Loads the sequencer set selected by SequencerSetSelector in the device.

<b>Name</b>	SequencerSetLoad
<b>Category</b>	SequencerControl
<b>Interface</b>	ICommand
<b>Access</b>	Write only
<b>Unit</b>	-
<b>Values</b>	-

### 7.14.8 SequencerSetNext

Specifies the next sequencer set.

<b>Name</b>	SequencerSetNext
<b>Category</b>	SequencerControl
<b>Interface</b>	IInteger
<b>Access</b>	Read / Write
<b>Unit</b>	-
<b>Values</b>	0 ... 127 (Increment: 1)

### 7.14.9 SequencerSetSave

Saves the current device state to the sequencer set selected by the SequencerSetSelector.

<b>Name</b>	SequencerSetSave
<b>Category</b>	SequencerControl
<b>Interface</b>	ICommand
<b>Access</b>	Write only
<b>Unit</b>	-
<b>Values</b>	-

### 7.14.10 SequencerSetSelector

Selects the sequencer set to which further feature settings applies.

<b>Name</b>	SequencerSetSelector
<b>Category</b>	SequencerControl
<b>Interface</b>	IInteger
<b>Access</b>	Read / Write
<b>Unit</b>	-
<b>Values</b>	0 ... 127 (Increment: 1)

### 7.14.11 SequencerSetStart

Sets the initial/start sequencer set, which is the first set used within a sequencer.

<b>Name</b>	SequencerSetStart
<b>Category</b>	SequencerControl
<b>Interface</b>	Integer
<b>Access</b>	Read / Write
<b>Unit</b>	-
<b>Values</b>	0 ... 127 (Increment: 1)

### 7.14.12 SequencerTriggerActivation

Defines the signals edge that triggers the sequencer.

<b>Name</b>	SequencerTriggerActivation	
<b>Category</b>	SequencerControl	
<b>Interface</b>	IEnumeration	
<b>Access</b>	Read / Write	
<b>Unit</b>	-	
<b>Values</b>	AnyEdge	Specifies that the trigger is considered valid on the falling or rising edge of the source signal.
	FallingEdge	Specifies that the trigger is considered valid on the falling edge of the source signal.
	LevelHigh*	Specifies that the trigger is considered valid as long as the level of the source signal is high.
	LevelLow*	Specifies that the trigger is considered valid as long as the level of the source signal is low.
	RisingEdge	Specifies that the trigger is considered valid on the rising edge of the source signal.

\*) ≥ Release 3

### 7.14.13 SequencerTriggerSource

Specifies the internal signal or physical input line to use as the sequencer trigger source.

<b>Name</b>	SequencerTriggerSource	
<b>Category</b>	SequencerControl	
<b>Interface</b>	IEnumeration	
<b>Access</b>	Read / Write	
<b>Unit</b>	-	
<b>Values</b>	Off	Disables the sequencer trigger.
	Counter-1End	Starts with the reception of the Counter End.
	Counter-2End	Starts with the reception of the Counter End.
	Line0	Specifies Line 0 as external trigger source.
	Line1*	Specifies Line 1 as external trigger source.
	Line2*	Specifies Line 2 as external trigger source.
	Line3**	Specifies Line 3 as external trigger source.
	Exposure-Active	Starts with the reception of the Exposure Active.
	ReadOutActive	Starts with the reception of the Read Out Active.
	Timer1End	Starts with the reception of the Timer End.

\*) ≥ Release 3

\*\*) only VCXG.I / .XT / .PTP / .I.PTP

## 7.15 Category: TransportLayerControl

This chapter provides the Transport Layer control features.

### 7.15.1 EnergyEfficientEthernetEnable (≥ Rel. 3 only)

Controls whether the Energy Efficient / Green Ethernet mode (802.3az) in the PHY is activated or not.

#### Notice

A device reboot is needed for changes to take effect.

<b>Name</b>	EnergyEfficientEthernetEnable	
<b>Category</b>	TransportLayerControl	
<b>Interface</b>	IBoolean	
<b>Access</b>	Read / Write	
<b>Unit</b>	-	
<b>Values</b>	true = 1 (On)	
	false = 0 (Off)	

## 7.15.2 Category: TransportLayerControl → GigE Vision

Category that contains the features pertaining to the GigE Vision transport layer of the device.

### 7.15.2.1 GVSPConfigurationBlockID64Bit

Enables the 64 bit block ID length.

<b>Name</b>	GVSPConfigurationBlockID64Bit
<b>Category</b>	TransportLayerControl → GigE Vision
<b>Interface</b>	IBoolean
<b>Access</b>	Read only
<b>Unit</b>	-
<b>Values</b>	true = 1 (On) false = 0 (Off)

### 7.15.2.2 GevCCP

Controls the device access privilege of an application.

<b>Name</b>	GevCCP
<b>Category</b>	TransportLayerControl → GigE Vision
<b>Interface</b>	IEnumeration
<b>Access</b>	Read / Write
<b>Unit</b>	-
<b>Values</b>	OpenAccess      Open Access. ExclusiveAccess      Exclusive Access. ControlAccess      Control Access.

### 7.15.2.3 GevCurrentDefaultGateway

Reports the default gateway IP address to be used on the given logical link.

<b>Name</b>	GevCurrentDefaultGateway
<b>Category</b>	TransportLayerControl → GigE Vision
<b>Interface</b>	IInteger
<b>Access</b>	Read only
<b>Unit</b>	-
<b>Values</b>	IP address

#### 7.15.2.4 GevCurrentIPAddress

Reports the IP address for the given logical link.

<b>Name</b>	GevCurrentIPAddress
<b>Category</b>	TansportLayerControl → GigEVision
<b>Interface</b>	IInteger
<b>Access</b>	Read only
<b>Unit</b>	-
<b>Values</b>	IP address

#### 7.15.2.5 GevCurrentIPConfigurationDHCP

Controls whether the DHCP IP configuration scheme is activated on the given logical link.

<b>Name</b>	GevCurrentIPConfigurationDHCP
<b>Category</b>	TansportLayerControl → GigEVision
<b>Interface</b>	IBoolean
<b>Access</b>	Read / Write
<b>Unit</b>	-
<b>Values</b>	true = 1 (On) false = 0 (Off)

#### 7.15.2.6 GevCurrentIPConfigurationLLA

Controls whether the Link Local Address IP configuration scheme is activated on the given logical link.

<b>Name</b>	GevCurrentIPConfigurationLLA
<b>Category</b>	TansportLayerControl → GigEVision
<b>Interface</b>	IBoolean
<b>Access</b>	Read only
<b>Unit</b>	-
<b>Values</b>	true = 1 (On) false = 0 (Off)

### 7.15.2.7 **GevCurrentIPConfigurationPersistentIP**

Controls whether the PersistentIP configuration scheme is activated on the given logical link.

<b>Name</b>	GevCurrentIPConfigurationPersistentIP
<b>Category</b>	TransportLayerControl → GigEVision
<b>Interface</b>	IBoolean
<b>Access</b>	Read / Write
<b>Unit</b>	-
<b>Values</b>	true = 1 (On) false = 0 (Off)

### 7.15.2.8 **GevCurrentSubnetMask**

Reports the subnet mask of the given logical link.

<b>Name</b>	GevCurrentSubnetMask
<b>Category</b>	TransportLayerControl → GigEVision
<b>Interface</b>	IInteger
<b>Access</b>	Read only
<b>Unit</b>	-
<b>Values</b>	IP address

### 7.15.2.9 **GevFirstURL**

Indicates the first URL to the GenICam XML device description file. The first URL is used as the first choice by the application to retrieve the GenICam XML device description file.

<b>Name</b>	GevFirstURL
<b>Category</b>	TransportLayerControl → GigEVision
<b>Interface</b>	IString
<b>Access</b>	Read only
<b>Unit</b>	-
<b>Values</b>	URL

### 7.15.2.10 **GevGVCPExtendedStatusCodes**

Enables the generation of extended status codes.

<b>Name</b>	GevGVCPExtendedStatusCodes
<b>Category</b>	TransportLayerControl → GigEVision
<b>Interface</b>	IBoolean
<b>Access</b>	Read / Write
<b>Unit</b>	-
<b>Values</b>	true = 1 (On) false = 0 (Off)



### 7.15.2.11 GevGVCPExtendedStatusCodesSelector

Selects the GigE Vision version to control extended status codes for.

<b>Name</b>	GevGVCPExtendedStatusCodesSelector	
<b>Category</b>	TansportLayerControl → GigEVision	
<b>Interface</b>	IEnumeration	
<b>Access</b>	Read / Write	
<b>Unit</b>	-	
<b>Values</b>	Version1_1	Version1_1.
	Version2_0	Version2_0.

### 7.15.2.12 GevGVCPPendingAck

Enables the generation of PENDING\_ACK.

<b>Name</b>	GevGVCPPendingAck	
<b>Category</b>	TansportLayerControl → GigEVision	
<b>Interface</b>	IBoolean	
<b>Access</b>	Read / Write	
<b>Unit</b>	-	
<b>Values</b>	true = 1 (On)	
	false = 0 (Off)	

### 7.15.2.13 GevIPConfigurationStatus

Reports the current IP configuration status.

<b>Name</b>	GevIPConfigurationStatus	
<b>Category</b>	TansportLayerControl → GigEVision	
<b>Interface</b>	IEnumeration	
<b>Access</b>	Read only	
<b>Unit</b>	-	
<b>Values</b>	None	None.
	PersistentIP	Persistent IP.
	DHCP	DHCP.
	LLA	LLA.
	ForceIP	Force IP.

#### 7.15.2.14 **GevInterfaceSelector**

Selects which logical link to control.

<b>Name</b>	GevInterfaceSelector
<b>Category</b>	TansportLayerControl → GigEVision
<b>Interface</b>	lInteger
<b>Access</b>	Read / Write
<b>Unit</b>	-
<b>Values</b>	≥ 0

#### 7.15.2.15 **GevMACAddress**

MAC address of the logical link.

<b>Name</b>	GevMACAddress
<b>Category</b>	TansportLayerControl → GigEVision
<b>Interface</b>	lInteger
<b>Access</b>	Read only
<b>Unit</b>	-
<b>Values</b>	≥ 0

#### 7.15.2.16 **GevMCDA**

Controls the destination IP address for the message channel.

<b>Name</b>	GevMCDA
<b>Category</b>	TansportLayerControl → GigEVision
<b>Interface</b>	lInteger
<b>Access</b>	Read / Write
<b>Unit</b>	-
<b>Values</b>	≥ 0

#### 7.15.2.17 **GevMCPHostPort**

Controls the port to which the device must send messages.

<b>Name</b>	GevMCPHostPort
<b>Category</b>	TansportLayerControl → GigEVision
<b>Interface</b>	lInteger
<b>Access</b>	Read / Write
<b>Unit</b>	-
<b>Values</b>	≥ 0

### 7.15.2.18 GevMCRC

Controls the number of retransmissions allowed when a message channel message times out.

<b>Name</b>	GevMCRC
<b>Category</b>	TansportLayerControl → GigEVision
<b>Interface</b>	Integer
<b>Access</b>	Read / Write
<b>Unit</b>	-
<b>Values</b>	$\geq 0$

### 7.15.2.19 GevMCSP

This feature indicates the source port for the message channel.

<b>Name</b>	GevMCSP
<b>Category</b>	TansportLayerControl → GigEVision
<b>Interface</b>	Integer
<b>Access</b>	Read only
<b>Unit</b>	-
<b>Values</b>	$\geq 0$

### 7.15.2.20 GevMCTT

Provides the transmission timeout value in milliseconds.

<b>Name</b>	GevMCTT
<b>Category</b>	TansportLayerControl → GigEVision
<b>Interface</b>	Integer
<b>Access</b>	Read only
<b>Unit</b>	ms
<b>Values</b>	$> 0$

### 7.15.2.21 GevNumberOfInterfaces

Indicates the number of logical links supported by this device.

<b>Name</b>	GevNumberOfInterfaces
<b>Category</b>	TansportLayerControl → GigEVision
<b>Interface</b>	Integer
<b>Access</b>	Read only
<b>Unit</b>	-
<b>Values</b>	$> 0$

### 7.15.2.22 **GevPAUSEFrameReception**

Controls whether incoming PAUSE Frames are handled on the given logical link.

<b>Name</b>	GevPAUSEFrameReception
<b>Category</b>	TansportLayerControl → GigE Vision
<b>Interface</b>	IBoolean
<b>Access</b>	Read only
<b>Unit</b>	-
<b>Values</b>	true = 1 (On) false = 0 (Off)

### 7.15.2.23 **GevPersistentDefaultGateway**

Controls the persistent default gateway for this logical link. It is only used when the device boots with the Persistent IP configuration scheme.

<b>Name</b>	GevPersistentDefaultGateway
<b>Category</b>	TansportLayerControl → GigE Vision
<b>Interface</b>	Integer
<b>Access</b>	Read / Write
<b>Unit</b>	-
<b>Values</b>	≥ 0

### 7.15.2.24 **GevPersistentIPAddress**

Controls the Persistent IP address for this logical link. It is only used when the device boots with the Persistent IP configuration scheme.

<b>Name</b>	GevPersistentIPAddress
<b>Category</b>	TansportLayerControl → GigE Vision
<b>Interface</b>	Integer
<b>Access</b>	Read / Write
<b>Unit</b>	-
<b>Values</b>	≥ 0

### 7.15.2.25 **GevPersistentSubnetMask**

Controls the Persistent subnet mask associated with the Persistent IP address on this logical link. It is only used when the device boots with the Persistent IP configuration scheme.

<b>Name</b>	GevPersistentSubnetMask
<b>Category</b>	TansportLayerControl → GigE Vision
<b>Interface</b>	Integer
<b>Access</b>	Read / Write
<b>Unit</b>	-
<b>Values</b>	≥ 0

### 7.15.2.26 **GevPrimaryApplicationIPAddress**

Returns the address of the primary application.

<b>Name</b>	GevPrimaryApplicationIPAddress
<b>Category</b>	TansportLayerControl → GigEVision
<b>Interface</b>	Integer
<b>Access</b>	Read only
<b>Unit</b>	-
<b>Values</b>	≥ 0

### 7.15.2.27 **GevPrimaryApplicationSocket**

Returns the UDP source port of the primary application.

<b>Name</b>	GevPrimaryApplicationSocket
<b>Category</b>	TansportLayerControl → GigEVision
<b>Interface</b>	Integer
<b>Access</b>	Read only
<b>Unit</b>	-
<b>Values</b>	≥ 0

### 7.15.2.28 **GevPrimaryApplicationSwitchoverKey**

Controls the key to use to authenticate primary application switchover requests.

<b>Name</b>	GevPrimaryApplicationSwitchoverKey
<b>Category</b>	TansportLayerControl → GigEVision
<b>Interface</b>	Integer
<b>Access</b>	Write only
<b>Unit</b>	-
<b>Values</b>	≥ 0

### 7.15.2.29 **GevSCDA**

Controls the destination IP address of the selected stream channel to which a GVSP transmitter must send data stream or the destination IP address from which a GVSP receiver may receive data stream.

<b>Name</b>	GevSCDA
<b>Category</b>	TansportLayerControl → GigEVision
<b>Interface</b>	Integer
<b>Access</b>	Read / Write
<b>Unit</b>	-
<b>Values</b>	≥ 0

### 7.15.2.30 GevSCFTD

This feature indicates the delay (in timestamp counter unit) to insert between each block (image) for this stream channel.

<b>Name</b>	GevSCFTD
<b>Category</b>	TransportLayerControl → GigEVision
<b>Interface</b>	Integer
<b>Access</b>	Read / Write
<b>Unit</b>	-
<b>Values</b>	0 ... 4294967295 (Increment: 1)

### 7.15.2.31 GevSCPD

Controls the delay (in timestamp counter unit) to insert between each packet for this stream channel. This can be used as a crude flow-control mechanism if the application or the network infrastructure cannot keep up with the packets coming from the device.

<b>Name</b>	GevSCPD
<b>Category</b>	TransportLayerControl → GigEVision
<b>Interface</b>	Integer
<b>Access</b>	Read / Write
<b>Unit</b>	-
<b>Values</b>	0 ... 4294967295 (Increment: 1)

### 7.15.2.32 GevSCPHostPort

Controls the port of the selected channel to which a GVSP transmitter must send data stream or the port from which a GVSP receiver may receive data stream. Setting this value to 0 closes the stream channel.

<b>Name</b>	GevSCPHostPort
<b>Category</b>	TransportLayerControl → GigEVision
<b>Interface</b>	Integer
<b>Access</b>	Read / Write
<b>Unit</b>	-
<b>Values</b>	0 ... 65535 (Increment: 1)

### 7.15.2.33 GevSCPIInterfaceIndex

Index of the logical link to use.

<b>Name</b>	GevSCPIInterfaceIndex
<b>Category</b>	TransportLayerControl → GigEVision
<b>Interface</b>	Integer
<b>Access</b>	Read / Write
<b>Unit</b>	-
<b>Values</b>	0 ... 3 (Increment: 1)

### 7.15.2.34 **GevSCPSDoNotFragment**

The state of this feature is copied into the "do not fragment" bit of IP header of each stream packet. It can be used by the application to prevent IP fragmentation of packets on the stream channel.

<b>Name</b>	GevSCPSDoNotFragment
<b>Category</b>	TansportLayerControl → GigEVison
<b>Interface</b>	IBoolean
<b>Access</b>	Read / Write
<b>Unit</b>	-
<b>Values</b>	true = 1 (On) false = 0 (Off)

### 7.15.2.35 **GevSCPSFireTestPacket**

Sends a test packet. When this feature is set, the device will fire one test packet.

<b>Name</b>	GevSCPSFireTestPacket
<b>Category</b>	TansportLayerControl → GigEVison
<b>Interface</b>	IBoolean
<b>Access</b>	Read / Write
<b>Unit</b>	-
<b>Values</b>	true = 1 (On) false = 0 (Off)

### 7.15.2.36 **GevSCSPPacketSize**

Specifies the stream packet size, in bytes, to send on the selected channel for a GVSP transmitter or specifies the maximum packet size supported by a GVSP receiver.

<b>Name</b>	GevSCSPPacketSize
<b>Category</b>	TansportLayerControl → GigEVison
<b>Interface</b>	IInteger
<b>Access</b>	Read / Write
<b>Unit</b>	Byte
<b>Values</b>	576 ... 16110 (Increment: 2)

### 7.15.2.37 **GevSCSP**

Indicates the source port of the stream channel.

<b>Name</b>	GevSCSP
<b>Category</b>	TansportLayerControl → GigEVison
<b>Interface</b>	IInteger
<b>Access</b>	Read only
<b>Unit</b>	-
<b>Values</b>	≥ 0

### 7.15.2.38 **GevSecondURL**

Indicates the second URL to the GenICam XML device description file. This URL is an alternative if the application was unsuccessful to retrieve the device description file using the first URL.

<b>Name</b>	GevSecondURL
<b>Category</b>	TansportLayerControl → GigEVision
<b>Interface</b>	IString
<b>Access</b>	Read only
<b>Unit</b>	-
<b>Values</b>	URL

### 7.15.2.39 **GevStreamChannelSelector**

Selects the stream channel to control.

<b>Name</b>	GevStreamChannelSelector
<b>Category</b>	TansportLayerControl → GigEVision
<b>Interface</b>	IInteger
<b>Access</b>	Read / Write
<b>Unit</b>	-
<b>Values</b>	≥ 0

### 7.15.2.40 **GevSupportedOption**

Returns if the selected GEV option is supported.

<b>Name</b>	GevSupportedOption
<b>Category</b>	TansportLayerControl → GigEVision
<b>Interface</b>	IBoolean
<b>Access</b>	Read only
<b>Unit</b>	-
<b>Values</b>	true = 1 (On) false = 0 (Off)



### 7.15.2.41 GevSupportedOptionSelector

Selects the GEV option to interrogate for existing support.

<b>Name</b>	GevSupportedOptionSelector
<b>Category</b>	TransportLayerControl → GigEVison
<b>Interface</b>	IEnumeration
<b>Access</b>	Read / Write
<b>Unit</b>	-
<b>Values</b>	see table below

Action	PacketResend
CCPApplicationSocket	PendingAck
CommandsConcatenation	PrimaryApplicationSwitchover
DiscoveryAckDelay	ScheduledAction
DiscoveryAckDelayWritable	SerialNumber
DynamicLAG	SingleLink
Event	StandardIDMode
EventData	StaticLAG
ExtendedStatusCodes	StreamChannel0AllInTransmission
ExtendedStatusCodesVersion2_0	StreamChannel0BigAndLittleEndian
HeartbeatDisable	StreamChannel0ExtendedChunkData
IEEE1588	StreamChannel0IPReassembly
IPConfigurationDHCP	StreamChannel0MultiZone
IPConfigurationLLA	StreamChannel0PacketResendDestination
IPConfigurationPersistentIP	StreamChannel0UnconditionalStreaming
LinkSpeed	StreamChannelSourceSocket
ManifestTable	TestData
MessageChannelSourceSocket	UnconditionalAction
MultiLink	UserDefinedName
PAUSEFrameGeneration	WriteMem
PAUSEFrameReception	

### 7.15.2.42 InterfaceSpeedMode

Show the interface speed mode as string.

<b>Name</b>	InterfaceSpeedMode	
<b>Category</b>	TansportLayerControl → GigEVison	
<b>Interface</b>	IEnumeration	
<b>Access</b>	Read only	
<b>Unit</b>	-	
<b>Values</b>	Ethernet100Mbps	Operation at 100 Mbps.
	Ethernet10Gbps	Operation at 10 Gbps.
	Ethernet1Gbps	Operation at 1 Gbps.
	Ethernet2_5Gbps	Operation at 2.5 Gbps.
	Ethernet5Gbps	Operation at 5 Gbps.

### 7.15.3 PayloadSize

Provides the number of bytes transferred for each image or chunk on the stream channel at the current settings. This includes any end-of-line, end-of-frame statistics or other stamp data. This is the total size of data payload for a data block.

<b>Name</b>	PayloadSize
<b>Category</b>	TansportLayerControl
<b>Interface</b>	Integer
<b>Access</b>	Read only
<b>Unit</b>	Byte
<b>Values</b>	0 ... depends on current settings (Increment: 1)

### 7.15.4 Category: Category: TransportLayerControl → PtpControl (.PTP only)

Category that contains the features related to the Precision Time Protocol (PTP) of the device.

#### General Information

IEEE 1588 Precision Time Protocol (PTP) manages clock synchronization of multiple devices across an Ethernet network. On a local area network, it achieves clock accuracy in the sub-microsecond range, making it suitable for measurement and control systems.

PTP was designed to improve on existing clock synchronization methods such as Network Time Protocol (NTP) and Global Positioning System (GPS). NTP suffers from poor accuracy, often quoted to be several milliseconds using a fast Ethernet network. GPS provides nanosecond precision using atomic clock and satellite triangulation; however, it is an expensive component to incorporate into a camera.

PTP provides microsecond precision without increasing component cost, providing better accuracy than NTP at a lower cost than GPS.

The diagram below shows the steps taken to synchronize the slave clock to that of the master.

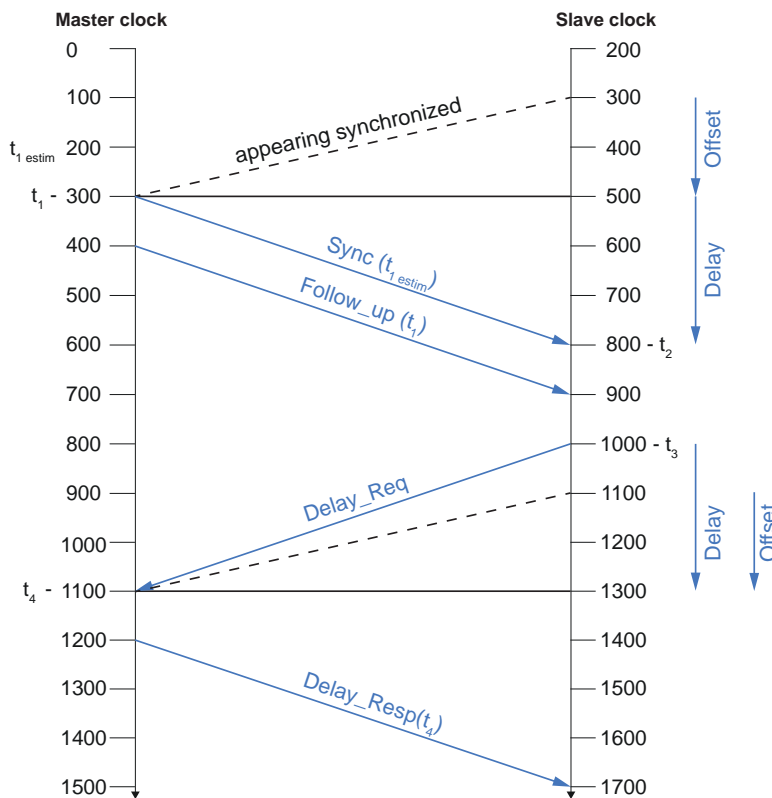

#### PTP synchronization

Synchronization begins when the device configured as the Master PTP clock transmits a *Sync* telegram using multicast messaging. Devices configured as Slave PTP clocks calculate the time difference between their clock and the Master PTP clock, and adjust accordingly.

Slave clock frequencies are constantly adjusted, through follow up and delay messages, to keep their clock value as close as possible to the master clock. While all Slave clocks are within 1  $\mu$ s of the master, PTP sync is achieved.

## Network Topology without GPS Clock

Achieving PTP synchronization between multiple cameras requires all cameras to be on the same network/subnet. The IEEE 1588 best master clock algorithm will select a camera as the master clock. Each camera will synchronize to this master clock.

This restriction is due to the current inability of any network card hardware to forward PTP sync multicast packets between ports within the 1  $\mu$ s requirement.

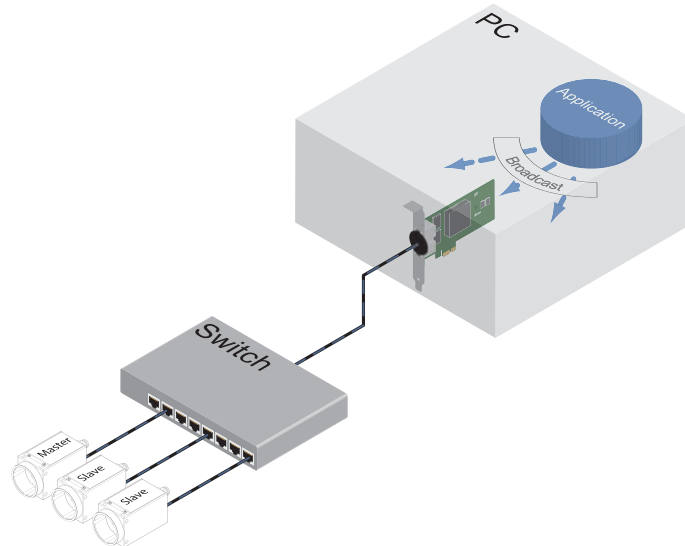

## Network Topology with GPS Clock

The cameras can be synchronized to a GPS timer, allowing “real world time” synchronization. Configure *PtpMode* on all of the cameras to *Slave* or *Auto*. In *Auto*, the IEEE 1588 best master clock algorithm will elect the GPS clock as the master. Each camera will synchronize to the GPS master clock.

### Notice

To ensure a reliable synchronization, the GPS master clock must be configured with a Sync interval between 0.5 s and 2 s (according to the Default PTP profile for use with the delay request-response mechanism).

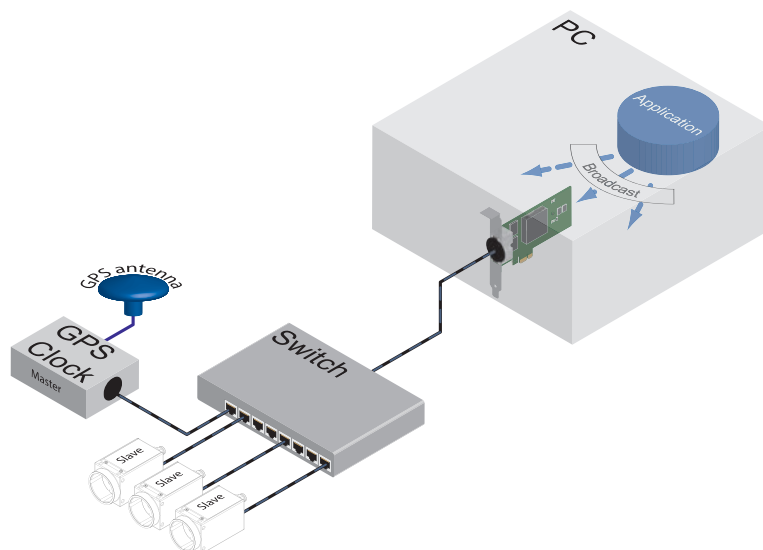

### 7.15.4.1 PtpClockAccuracy

Indicates the expected accuracy of the device PTP clock when it is the grandmaster, or in the event it becomes the grandmaster.

<b>Name</b>	PtpClockAccuracy
<b>Category</b>	TansportLayerControl → PtpControl
<b>Interface</b>	IEnumeration
<b>Access</b>	Read only
<b>Unit</b>	-
<b>Values</b>	Within1us Within2p5u

### 7.15.4.2 PtpClockID

Returns the latched clock ID of the PTP device. PTP Parent Clock ID.

<b>Notice</b>
Byte 0 of the IEEE ClockIdentity field is mapped to the MSB.

<b>Name</b>	PtpClockID
<b>Category</b>	TansportLayerControl → PtpControl
<b>Interface</b>	IInteger
<b>Access</b>	Read only
<b>Unit</b>	MacAdress
<b>Values</b>	80-00-00-00-00-00 ... 7F-FF-FF-FF-FF-FF-FF (Increment: 1)

### 7.15.4.3 PtpDataSetLatch

Latches the current values from the device's PTP clock data set.

<b>Name</b>	PtpDataSetLatch
<b>Category</b>	TansportLayerControl → PtpControl
<b>Interface</b>	ICommand
<b>Access</b>	Write only
<b>Unit</b>	-
<b>Values</b>	-

#### 7.15.4.4 PtpEnable

Enables the Precision Time Protocol (PTP).

##### Notice

To write this feature, set `TLParamsLocked = 0`.

<b>Name</b>	PtpEnableEnable
<b>Category</b>	TansportLayerControl → PtpControl
<b>Interface</b>	IBoolean
<b>Access</b>	Read/Write
<b>Unit</b>	-
<b>Values</b>	true = 1 (On)
	false = 0 (Off)

#### 7.15.4.5 PtpGrandmasterClockID

Returns the latched grandmaster clock ID of the PTP device. The grandmaster clock ID is the clock ID of the current grandmaster clock.

##### Notice

Byte 0 of the IEEE ClockIdentity field is mapped to the MSB.

<b>Name</b>	PtpGrandmasterClockID
<b>Category</b>	TansportLayerControl → PtpControl
<b>Interface</b>	Integer
<b>Access</b>	Read only
<b>Unit</b>	MacAddress
<b>Values</b>	80-00-00-00-00-00 ... 7F-FF-FF-FF-FF-FF-FF (Increment: 1)

#### 7.15.4.6 PtpMode

Selects the PTP clock type the device will act as.

<b>Name</b>	PtpMode	
<b>Category</b>	TansportLayerControl → PtpControl	
<b>Interface</b>	IEnumeration	
<b>Access</b>	Read/Write	
<b>Unit</b>	-	
<b>Values</b>	Auto	The device uses the IEEE 1588 best master clock algorithm to determine which device is master, and which devices are slaves. In case the device is not the best master, it will act as a PTP slave.
	Slave	The device's clock will act as a PTP slave only to align with a master device's clock.

### 7.15.4.7 PtpOffsetFromMaster

Returns the latched offset from the PTP master clock in nanoseconds.

<b>Name</b>	PtpOffsetFromMaster
<b>Category</b>	TansportLayerControl → PtpControl
<b>Interface</b>	Integer
<b>Access</b>	Read only
<b>Unit</b>	ns
<b>Values</b>	-9223372036854775808 ... 9223372036854775808 (Increment: 1)

### 7.15.4.8 PtpParentClockID

Returns the latched parent clock ID of the PTP device. The parent clock ID is the clock ID of the current master clock.

#### Notice

Byte 0 of the IEEE ClockIdentity field is mapped to the MSB.

<b>Name</b>	PtpParentClockID
<b>Category</b>	TansportLayerControl → PtpControl
<b>Interface</b>	Integer
<b>Access</b>	Read only
<b>Unit</b>	MacAdress
<b>Values</b>	80-00-00-00-00-00 ... 7F-FF-FF-FF-FF-FF-FF (Increment: 1)

### 7.15.4.9 PtpServoStatus

#### Notice

PTPServoStatus may change temporarily when changing the IP address.

Returns the latched state of the clock servo.

When the servo is in a locked state, the value returned is 'Locked'. When the servo is in a non-locked state, a device-specific value can be returned to give specific information. If no device-specific value is available to describe the current state of the clock servo, the value should be 'Unknown'.

<b>Name</b>	PtpServoStatus
<b>Category</b>	TansportLayerControl → PtpControl
<b>Interface</b>	IEnumeration
<b>Access</b>	Read only
<b>Unit</b>	-
<b>Values</b>	Unknown
	Locked

### 7.15.4.10 PtpStatus

Returns the latched state of the PTP clock.

<b>Name</b>	PtpStatus	
<b>Category</b>	TansportLayerControl → PtpControl	
<b>Interface</b>	IEnumeration	
<b>Access</b>	Read only	
<b>Unit</b>	-	
<b>Values</b>	Disabled	PTP is disabled.
	Faulty	The fault state of the protocol.
	Initializing	PTP is being initialized.
	Listening	Device is listening for other PTP enabled devices.
	Master	Device acting as master clock.
	Passive	If there are 2 or more devices with PtpMode = Master, this device has an inferior clock and is not synchronized to the master.
	Pre_Master	The port shall behave in all respects as though it were in the MASTER state except that it shall not place any messages on its communication path except for Pdelay_Req, Pdelay_Resp, Pdelay_Resp_Follow_Up, signaling, or management messages.
	Slave	PTP synchronization between this device and master is achieved.
	Uncalibrated	PTP synchronization not yet achieved.

### 7.15.5 Category: TransportLayerControl → USB3Vision

Category that contains the features pertaining to the USB3 Vision transport layer of the device.

#### 7.15.5.1 InterfaceSpeedMode

Show the interface speed mode as string.

<b>Name</b>	InterfaceSpeedMode	
<b>Category</b>	TansportLayerControl → USB3Vision	
<b>Interface</b>	IEnumeration	
<b>Access</b>	Read only	
<b>Unit</b>	-	
<b>Values</b>	FullSpeed	USB operation at 12 Mbps.
	HighSpeed	USB operation at 480 Mbps.
	LowSpeed	USB operation at 1.5 Mbps.
	SuperSpeed	USB operation at 5 Gbps.



### 7.15.5.2 SIControl

Controls streaming operation.

<b>Name</b>	SIControl	
<b>Category</b>	TansportLayerControl → USB3Vision	
<b>Interface</b>	IEnumeration	
<b>Access</b>	Read only	
<b>Unit</b>	-	
<b>Values</b>	StreamDisabled	Disable Streaming.
	StreamEnabled	Enable Streaming.

### 7.15.5.3 SIPayloadFinalTransfer1Size

Size of first final Payload Transfer.

<b>Name</b>	SIPayloadFinalTransfer1Size	
<b>Category</b>	TansportLayerControl → USB3Vision	
<b>Interface</b>	Integer	
<b>Access</b>	Read only	
<b>Unit</b>	Byte	
<b>Values</b>	0 - 4294967295 (Increment: 1)	

### 7.15.5.4 SIPayloadFinalTransfer2Size

Size of second final Payload Transfer.

<b>Name</b>	SIPayloadFinalTransfer2Size	
<b>Category</b>	TansportLayerControl → USB3Vision	
<b>Interface</b>	Integer	
<b>Access</b>	Read only	
<b>Unit</b>	Byte	
<b>Values</b>	0 - 4294967295 (Increment: 1)	

### 7.15.5.5 SIPayloadTransferCount

Expected number of Payload Transfers.

<b>Name</b>	SIPayloadTransferCount	
<b>Category</b>	TansportLayerControl → USB3Vision	
<b>Interface</b>	Integer	
<b>Access</b>	Read only	
<b>Unit</b>	-	
<b>Values</b>	0 - 4294967295 (Increment: 1)	

### 7.15.5.6 SIPayloadTransferSize

Expected size of a single Payload Transfer.

<b>Name</b>	SIPayloadTransferSize
<b>Category</b>	TransportLayerControl → USB3Vision
<b>Interface</b>	Integer
<b>Access</b>	Read only
<b>Unit</b>	Byte
<b>Values</b>	0 - 4294967295 (Increment: 1)

## 7.16 Category: UserSetControl

Category that contains the User Set control features. It allows loading or saving factory or user-defined settings.

Loading the factory default User Set guarantees a state where a continuous acquisition can be started using only the mandatory features.

These user sets are stored within the camera and can be loaded, saved and transferred to other cameras.

By using *User Set Default* one of these four user sets can be set as the default, which means that the camera starts up with these adjusted parameters.

### 7.16.1 UserSetDefault

Four user sets are available for this camera. *User Set 1*, *User Set 2*, *User Set 3* are user-specific and can contain user-definable parameters.

Selects the feature *UserSet* to load and make active by default when the device is reset. The factory settings are stored in the user set *Default*. This is the only user set that cannot be edited.

#### Notice

All saved user sets can be set as default.

<b>Name</b>	UserSetDefault
<b>Category</b>	UserSetControl
<b>Interface</b>	IEnumeration
<b>Access</b>	Read / Write
<b>Unit</b>	-
<b>Values</b>	Default      Select the factory setting user set.
	User Set 1      Select the User Set 1 (available when saved).
	User Set 2      Select the User Set 2 (available when saved).
	User Set 3      Select the User Set 3 (available when saved).

### 7.16.2 UserSetFeatureEnable

Enables the selected feature and make it active in all the UserSets.

<b>Name</b>	UserSetFeatureEnable
<b>Category</b>	UserSetControl
<b>Interface</b>	IBoolean
<b>Access</b>	Read only
<b>Unit</b>	-
<b>Values</b>	true = 1 (On) false = 0 (Off)

### 7.16.3 UserSetFeatureSelector

Selects which individual UserSet feature to control.

<b>Name</b>	UserSetFeatureSelector
<b>Category</b>	UserSetControl
<b>Interface</b>	IEnumeration
<b>Access</b>	Read / Write
<b>Unit</b>	-
<b>Values</b>	see tables below

#### Notice

##### Compatibility Gain

A *Gain* saved with Release 2 cameras in the UserSet is not compatible with Release 3 cameras.

**VCXG/.XC/.I/.XT**

<b>Parameter</b>		
AcquisitionFrameCount	DefectPixelCorrection	PixelFormat
AcquisitionFrameRate	DeviceTemperature-StatusTransition	ReadoutMode
AcquisitionFrameRate-Enable	EventNotification	ReverseX
AcquisitionMode	ExposureMode	ReverseY
ActionDeviceKey	ExposureTime	SensorShutterMode (≥ Rel. 3)
ActionGroupKey	FixedPatternNoiseCorrection	SequencerSetNext (≥ Rel. 2)
ActionGroupMask	FrameCounter	SequencerSetStart (≥ Rel. 2)
AutoFeatureHeight (≥ Rel. 3)	Gain	SequencerTrigger-Activation (≥ Rel. 2)
AutoFeatureOffsetX (≥ Rel. 3)	GainAuto (≥ Rel. 3)	SequencerTrigger-Source (≥ Rel. 2)
AutoFeatureOffsetY (≥ Rel. 3)	GainAutoMaxValue (≥ Rel. 3)	TestPattern
AutoFeatureWidth (≥ Rel. 3)	GainAutoMinValue (≥ Rel. 3)	TimerDelay
BalanceWhiteAuto	Gamma	TimerDuration
BinningHorizontal	GevSCFTD	TimerTriggerActivation
BinningHorizontalMode	GevSCPD	TimerTriggerSource
BinningVertical	Height	TriggerActivation
BinningVerticalMode	LUTContent	TriggerDelay
BlackLevel	LUTEnable	TriggerMode
BrightnessAutoNominalValue	LUTValue	TriggerSource
BrightnessAutoPriority	LineDebouncerHighTimeAbs	UserOutputValue
ChunkEnable	LineDebouncerLowTimeAbs	UserOutputValueAll
ChunkModeActive	LineInverter	Width
ColorTransformation-Value	LineMode (≥ Rel. 3)	
CounterDuration	LinePWMDuration (VCXG.I / .XT only)	
CounterEventActivation	LinePWMMaxDuration (VCXG.I / .XT only)	
CounterEventSource	LinePWMMode (VCXG.I / .XT only)	
DeviceLinkThroughput-Limit	LineSource	
CounterResetActivation	OffsetX	
CounterResetSource	OffsetY	

## VCXU

Parameter		
AcquisitionFrameCount	ExposureAuto	ReverseY
AcquisitionFrameRate	ExposureAutoMaxValue	SensorShutterMode (≥ Rel. 3)
AcquisitionFrameRate- Enable	ExposureAutoMinValue	SequencerSetNext (≥ Rel. 2)
AcquisitionMode	ExposureMode	SequencerSetStart (≥ Rel. 2)
AutoFeatureHeight (≥ Rel. 3)	ExposureTime	SequencerTrigger- Activation (≥ Rel. 2)
AutoFeatureOffsetX (≥ Rel. 3)	FixedPatternNoise- Correction	SequencerTrigger- Source (≥ Rel. 2)
AutoFeatureOffsetY (≥ Rel. 3)	FrameCounter	TestPattern
AutoFeatureWidth (≥ Rel. 3)	Gain	TimerDelay
BinningHorizontal	GainAuto (≥ Rel. 3)	TimerDuration
BinningHorizontalMode	GainAutoMaxValue (≥ Rel. 3)	TimerTriggerActivation
BinningVertical	GainAutoMinValue (≥ Rel. 3)	TimerTriggerSource
BinningVerticalMode	Gamma	TriggerActivation
BlackLevel	Height	TriggerDelay
BrightnessAutoNominal- Value	LUTContent	TriggerMode
BrightnessAutoPriority	LUTEnable	TriggerSource
ChunkEnable	LUTValue	UserOutputValue
ChunkModeActive		UserOutputValueAll
ColorTransformationAuto	LineDebouncerHigh-Time- Abs	Width
CounterDuration	LineDebouncerLow- TimeAbs	
CounterEventActivation	LineInverter	
CounterEventSource	LineMode (≥ Rel. 3)	
CounterResetActivation	LineSource	
CounterResetSource	OffsetX	
DefectPixelCorrection	OffsetY	
DeviceLinkThroughputLimit	PixelFormat	
DeviceTemperatureStatus- Transition	ReadoutMode	
EventNotification	ReverseX	

### 7.16.4 UserSetLoad

Loads the *UserSet* specified by *UserSetSelector* to the device and makes it active.

#### Notice

Loading a *UserSet* requires the stop of the camera.

<b>Name</b>	UserSetLoad
<b>Category</b>	UserSetControl
<b>Interface</b>	ICommand
<b>Access</b>	Write only
<b>Unit</b>	-
<b>Values</b>	-

### 7.16.5 UserSetSave

Save the User Set specified by *UserSetSelector* to the non-volatile memory of the device.

#### Notice

The factory settings are stored in the user set *Default*. This is the only user set that cannot be edited. Select at *UserSetSelector* *UserSet1*, *UserSet2* or *UserSet3*.

<b>Name</b>	UserSetSave
<b>Category</b>	UserSetControl
<b>Interface</b>	ICommand
<b>Access</b>	Write only
<b>Unit</b>	-
<b>Values</b>	-

### 7.16.6 UserSetSelector

Selects the Feature User Set to load, save or configure. The factory settings are stored in the user set *Default*. This is the only user set that cannot be edited.

<b>Name</b>	UserSetSelector	
<b>Category</b>	UserSetControl	
<b>Interface</b>	IEnumeration	
<b>Access</b>	Read / Write	
<b>Unit</b>	-	
<b>Values</b>	Default	Select the factory setting user set.
	User Set 1	Select the User Set 1.
	User Set 2	Select the User Set 2.
	User Set 3	Select the User Set 3.

## 8. VCXG /.XC/.I/.I.XT/.PTP /.I.PTP – Interface Functionalities

### 8.1 Device Information

This Gigabit Ethernet-specific information on the device is part of the Discovery-Acknowledge of the camera.

Included information:

- MAC address
- Current IP configuration (persistent IP / DHCP / LLA)
- Current IP parameters (IP address, subnet mask, gateway)
- Manufacturer's name
- Manufacturer-specific information
- Device version
- Serial number
- User-defined name (user programmable string)

### 8.2 Packet Size and Maximum Transmission Unit (MTU)

Network packets can be of different sizes. The size depends on the network components employed. When using GigE Vision® compliant devices, it is generally recommended to use larger packets. On the one hand the overhead per packet is smaller, on the other hand larger packets cause less CPU load.

The packet size of UDP packets can differ from 576 Bytes up to the MTU.

The MTU describes the maximal packet size which can be handled by all network components involved.

In principle modern network hardware supports a packet size of 1500 Byte, which is specified in the GigE network standard. "Jumboframes" merely characterizes a packet size exceeding 1500 Bytes.

Baumer VCXG cameras can handle a MTU of up to 16384 Bytes.

### 8.3 Inter Packet Gap (IPG)

To achieve optimal results in image transfer, several Ethernet-specific factors need to be considered.

Upon starting the image transfer of a camera, the data packets are transferred at maximum transfer speed (1 Gbit/sec). In accordance with the network standard, Baumer employs a minimal separation of 12 Bytes between two packets. This separation is called "inter packet gap" (IPG). In addition to the minimal IPG, the GigE Vision® standard stipulates that the IPG be scalable (user-defined).

#### Notice

According to the Ethernet standard,  $IPG_{min}$  can not be lower than 12 Bytes.

**IPG:**  
*The IPG is measured in ticks.  
An easy rule of thumb is:  
  
1 Tick is equivalent to 1 Bit of data.  
You should also not forget to add the various ethernet headers to your calculation.*

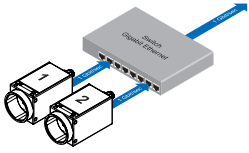

Operation of two cameras employing a Gigabit Ethernet switch. Data processing within the switch is displayed in the next two figures.

### 8.3.1 Example 1: Multi Camera Operation – Minimal IPG

Setting the IPG to minimum means every image is transferred at maximum speed. Even by using a frame rate of 1 fps this results in full load on the network. Such "bursts" can lead to an overload of several network components and a loss of packets. This can occur, especially when using several cameras.

In the case of two cameras sending images at the same time, this would theoretically occur at a transfer rate of 2 Gbits/sec. The switch has to buffer this data and transfer it at a speed of 1 Gbit/sec afterwards. Depending on the internal buffer of the switch, this operates without any problems up to n cameras (n ≥ 1). More cameras would lead to a loss of packets. These lost packets can however be saved by employing an appropriate resend mechanism, but this leads to additional load on the network components.

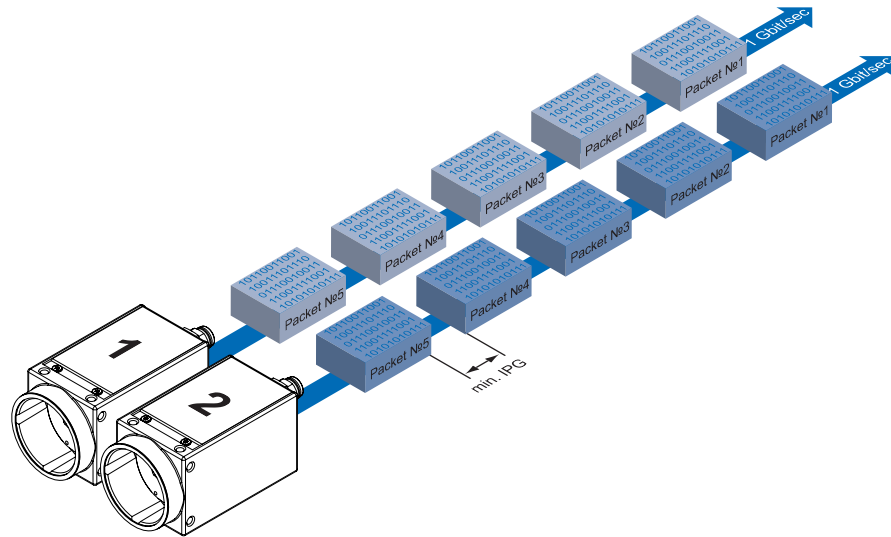

Operation of two cameras employing a minimal inter packet gap (IPG).

### 8.3.2 Example 2: Multi Camera Operation – Optimal IPG

A better method is to increase the IPG to a size of

$$\text{optimal IPG} = (\text{number of cameras} - 1) * \text{packet size} + 2 \times \text{minimal IPG}$$

In this way both data packets can be transferred successively (zipper principle), and the switch does not need to buffer the packets.

**Max. IPG:**  
On the Gigabit Ethernet the max. IPG and the data packet must not exceed 1 Gbit. Otherwise data packets can be lost.

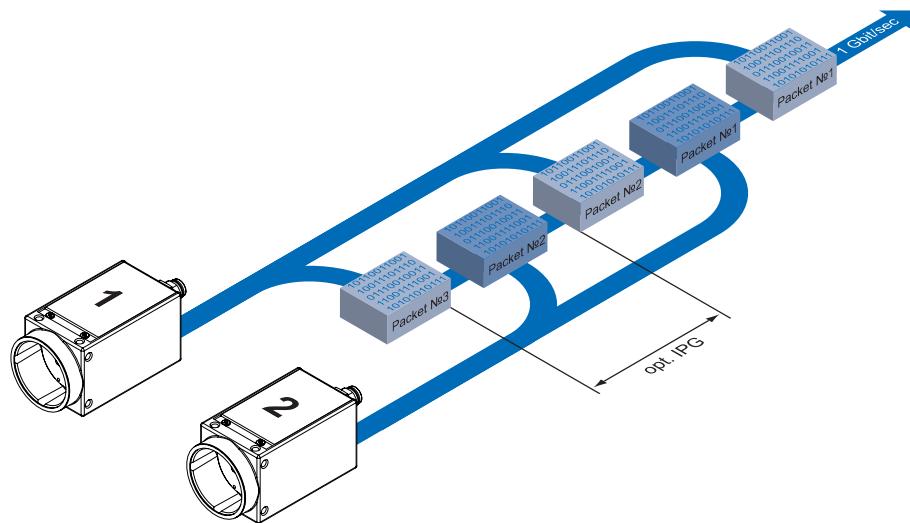

Operation of two cameras employing an optimal inter packet gap (IPG).



## 8.4 Transmission Delay

Another approach for packet sorting in multi-camera operation is the so-called Transmission Delay.

Due to the fact, that the currently recorded image is stored within the camera and its transmission starts with a predefined delay, complete images can be transmitted to the PC at once.

The following figure should serve as an example:

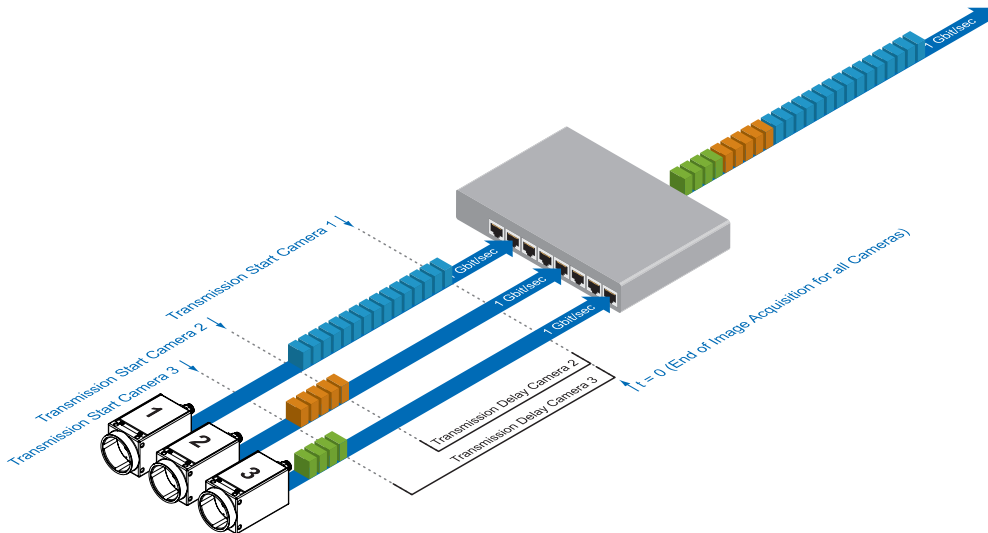

Principle of the transmission delay.

For the image processing three cameras are employed – for example camera 1: VCXG-53M, camera 2: VCXG-13M, camera 3: VCXG-23M.

Due to process-related circumstances, the image acquisitions of all cameras end at the same time. Now the cameras are not trying to transmit their images simultaneously, but – according to the specified transmission delays – subsequently. Thereby the first camera starts the transmission immediately – with a transmission delay "0".

### 8.4.1 Time Saving in Multi-Camera Operation

As previously stated, the transmission delay feature was especially designed for multi-camera operation with employment of different camera models. Just here an significant acceleration of the image transmission can be achieved:

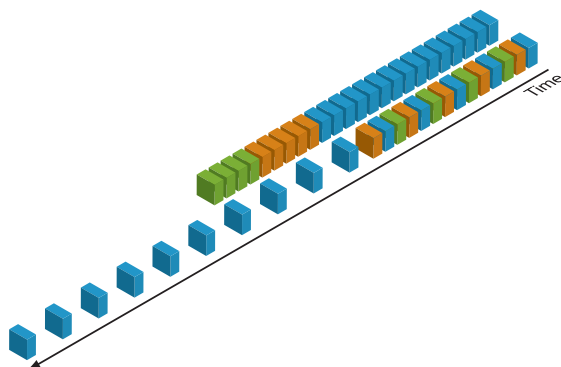

Comparison of transmission delay and inter packet gap, employed for a multi-camera system with different camera models.

For the above mentioned example, the employment of the transmission delay feature results in a time saving – compared to the approach of using the inter packet gap – of approx. 45% (applied to the transmission of all three images).

## 8.4.2 Configuration Example

For the three employed cameras the following data are known:

Camera Model	Sensor Resolution [pixel]	Pixel Format (Pixel Depth) [bit]	Resulting Data Volume [bit]	Readout Time [msec]	Exposure Time [msec]	Transfer Time (GigE) [msec]
VCXG-53M	2592 x 2048	8	42467328	35.3	20	≈ 42.47
VCXG-13M	1280 x 1024	8	10485760	6.74	20	≈ 10.48
VCXG-23M	1920 x 1200	8	18432000	12.2	20	≈ 18.43

- The sensor resolution and the readout time ( $t_{\text{readout}}$ ) can be found in the respective Technical Data Sheet (TDS). For the example a full frame resolution is used.
- The exposure time ( $t_{\text{exposure}}$ ) is manually set to 20 msec.
- The resulting data volume is calculated as follows:  

$$\text{Resulting Data Volume} = \text{horizontal Pixels} \times \text{vertical Pixels} \times \text{Pixel Depth}$$
- The transfer time ( $t_{\text{transferGigE}}$ ) for full GigE transfer rate is calculated as follows:  

$$\text{Transfer Time (GigE)} = \text{Resulting Data Volume} / 1000^3 \times 1000 [\text{msec}]$$

All the cameras are triggered simultaneously.

The transmission delay is realized as a counter, that is started immediately after the sensor readout is started.

Timings:
A - exposure start for all cameras
B - all cameras ready for transmission
C - transmission start camera 2
D - transmission start camera 3

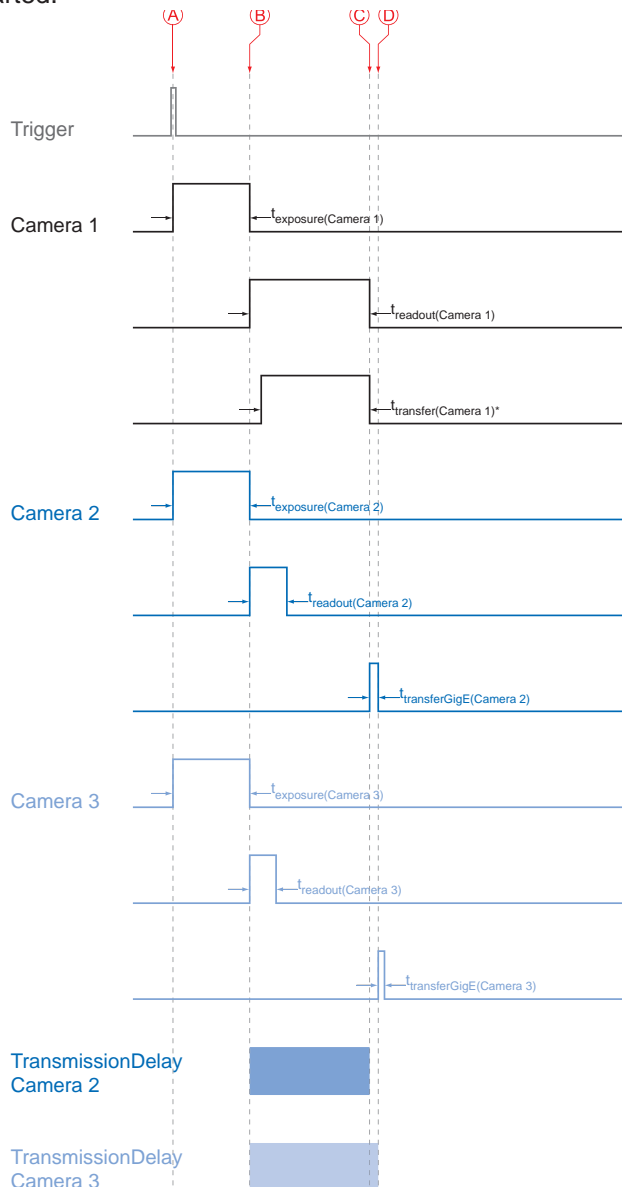

\* Due to technical issues the data transfer of camera 1 does not take place with full GigE speed.

Timing diagram for the transmission delay of the three employed cameras, using even exposure times.

In general, the transmission delay is calculated as:

$$t_{TransmissionDelay(Camera\ n)} = t_{exposure(Camera\ 1)} + t_{readout(Camera\ 1)} - t_{exposure(Camera\ n)} + \sum_{n=3}^n t_{transferGigE(Camera\ n-1)}$$

Therewith for the example, the transmission delays of camera 2 and 3 are calculated as follows:

$$t_{TransmissionDelay(Camera\ 2)} = t_{exposure(Camera\ 1)} + t_{readout(Camera\ 1)} - t_{exposure(Camera\ 2)}$$

$$t_{TransmissionDelay(Camera\ 3)} = t_{exposure(Camera\ 1)} + t_{readout(Camera\ 1)} - t_{exposure(Camera\ 3)} + t_{transferGige(Camera\ 2)}$$

Solving this equations leads to:

$$\begin{aligned} t_{TransmissionDelay(Camera\ 2)} &= 20\ msec + 35.3\ msec - 20\ msec \\ &= 35.3\ msec \\ &= 35300000\ ticks \end{aligned}$$

$$\begin{aligned} t_{TransmissionDelay(Camera\ 3)} &= 20\ msec + 35.3\ msec - 20\ msec + 10.48\ msec \\ &= 45.78\ msec \\ &= 45780000\ ticks \end{aligned}$$

#### Notice

In Baumer GAPI the delay is specified in ticks. How do convert microseconds into ticks?

$$1\ tick = 1\ ns$$

$$1\ msec = 1000000\ ns$$

$$1\ tick = 0,000001\ msec$$

$$ticks = t_{TransmissionDelay} [msec] / 0.000001 = t_{TransmissionDelay} [ticks]$$

## 8.5 Multicast

Multicasting offers the possibility to send data packets to more than one destination address – without multiplying bandwidth between camera and Multicast device (e.g. Router or Switch).

The data is sent out to an intelligent network node, an IGMP (Internet Group Management Protocol) capable Switch or Router and distributed to the receiver group with the specific address range.

In the example on the figure below, multicast is used to process image and message data separately on two different PC's.

### Multicast Addresses:

For multicasting Bauer suggests an address range from 232.0.1.0 to 232.255.255.255.

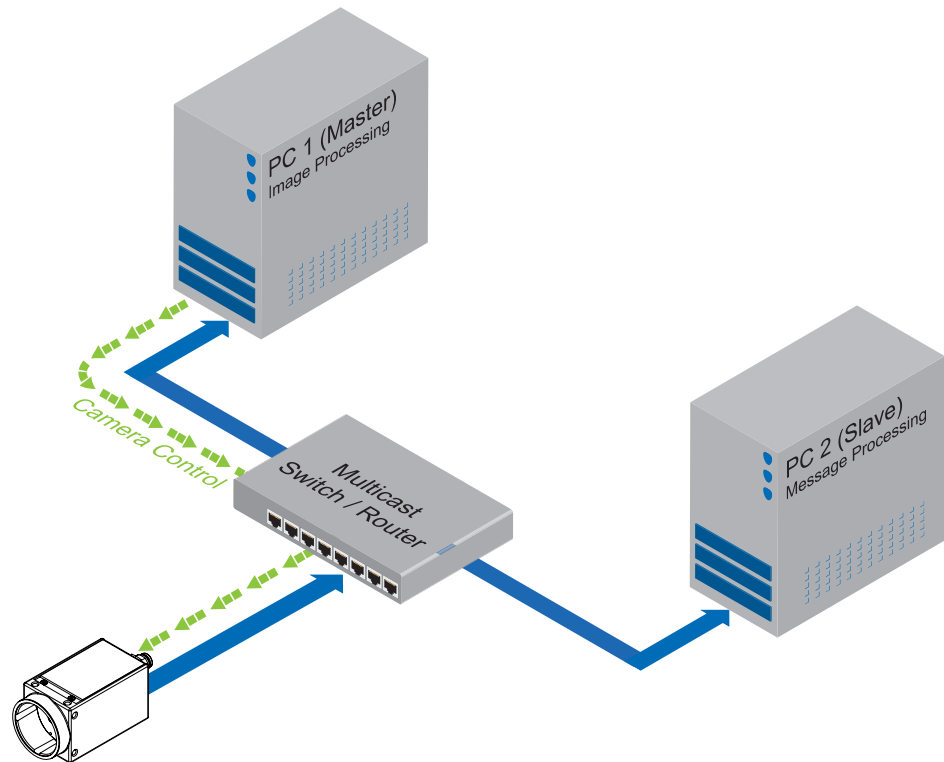

## 8.6 IP Configuration

### 8.6.1 Persistent IP

A persistent IP address is assigned permanently. Its validity is unlimited.

#### Notice

Please ensure a valid combination of IP address and subnet mask.

IP range:	Subnet mask:
0.0.0.0 – 127.255.255.255	255.0.0.0
128.0.0.0 – 191.255.255.255	255.255.0.0
192.0.0.0 – 223.255.255.255	255.255.255.0

These combinations are not checked by Baumer GAPI, Baumer GAPI Viewer or camera on the fly. This check is performed when restarting the camera, in case of an invalid IP - subnet combination the camera will start in LLA mode.

\* This feature is disabled by default.

### 8.6.2 DHCP (Dynamic Host Configuration Protocol)

The DHCP automates the assignment of network parameters such as IP addresses, subnet masks and gateways. This process takes up to 12 sec.

Once the device (client) is connected to a DHCP-enabled network, four steps are processed:

- DHCP Discovery

In order to find a DHCP server, the client sends a so called DHCPDISCOVER broadcast to the network.

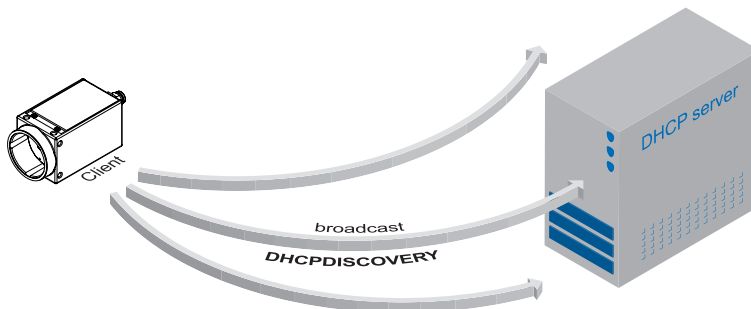

- DHCP Offer

After reception of this broadcast, the DHCP server will answer the request by an unicast, known as DHCP OFFER. This message contains several items of information, such as:

Information for the client	MAC address
	offered IP address
Information on server	IP address
	subnet mask
	duration of the lease

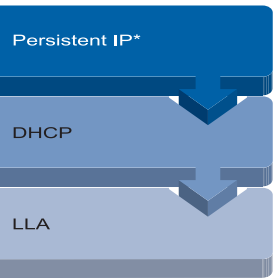
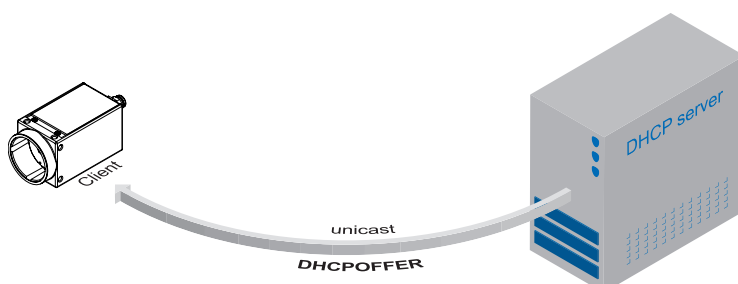

Connection pathway for Baumer Gigabit Ethernet cameras:

The device connects step by step via the three described mechanisms.

**DHCP:**  
Please pay attention to the DHCP Lease Time.

DHCP Discovery  
(broadcast)

DHCP offer (unicast)

- **DHCP Request**  
Once the client has received this DHCP OFFER, the transaction needs to be confirmed. For this purpose the client sends a so called DHCPREQUEST broadcast to the network. This message contains the IP address of the offering DHCP server and informs all other possible DHCP servers that the client has obtained all the necessary information, and there is therefore no need to issue IP information to the client.

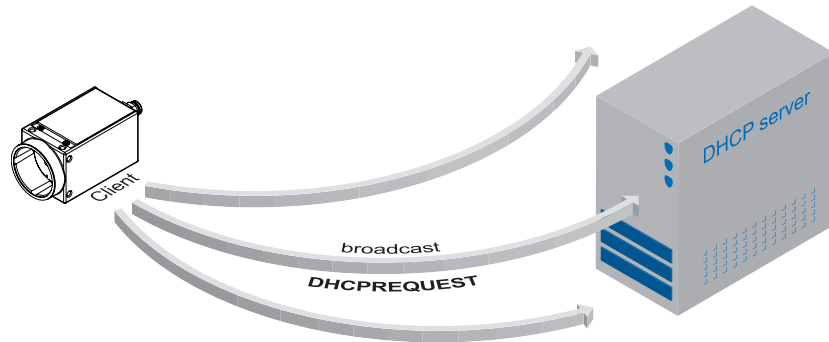

DHCP Request  
(broadcast)

- **DHCP Acknowledgement**  
Once the DHCP server obtains the DHCPREQUEST, an unicast containing all necessary information is sent to the client. This message is called DHCPACK. According to this information, the client will configure its IP parameters and the process is complete.

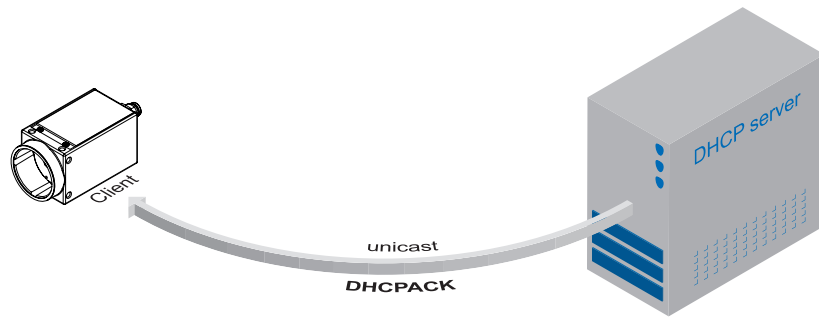

DHCP Acknowledgement  
(unicast)

**DHCP Lease Time:**

The validity of DHCP IP addresses is limited by the lease time. When this time is elapsed, the IP configuration needs to be redone. This causes a connection abort.

**8.6.3 LLA**

LLA (Link-Local Address) refers to a local IP range from 169.254.0.1 to 169.254.254.254 and is used for the automated assignment of an IP address to a device when no other method for IP assignment is available.

The IP address is determined by the host, using a pseudo-random number generator, which operates in the IP range mentioned above.

Once an address is chosen, this is sent together with an ARP (Address Resolution Protocol) query to the network to check if it already exists. Depending on the response, the IP address will be assigned to the device (if not existing) or the process is repeated. This method may take some time - the GigE Vision® standard stipulates that establishing connection in the LLA should not take longer than 40 seconds, in the worst case it can take up to several minutes.

**8.6.4 Force IP<sup>1)</sup>**

Inadvertent faulty operation may result in connection errors between the PC and the camera. In this case "Force IP" may be the last resort. The Force IP mechanism sends an IP address and a subnet mask to the MAC address of the camera. These settings are sent without verification and are adapted immediately by the client. They remain valid until the camera is de-energized.

1) In the GigE Vision® standard, this feature is defined as "Static IP".

## 8.7 Packet Resend

Due to the fact, that the GigE Vision® standard stipulates using a UDP - a stateless user datagram protocol - for data transfer, a mechanism for saving the "lost" data needs to be employed.

Here, a resend request is initiated if one or more packets are damaged during transfer and - due to an incorrect checksum - rejected afterwards.

On this topic one must distinguish between three cases:

### 8.7.1 Normal Case

In the case of unproblematic data transfer, all packets are transferred in their correct order from the camera to the PC. The probability of this happening is more than 99%.

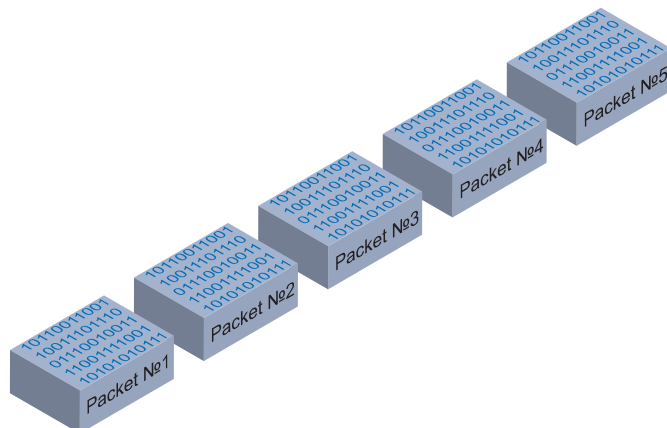

Data stream without damaged or lost packets.

### 8.7.2 Fault 1: Lost Packet within Data Stream

If one or more packets are lost within the data stream, this is detected by the fact, that packet number  $n$  is not followed by packet number  $(n+1)$ . In this case the application sends a resend request (A). Following this request, the camera sends the next packet and then resends (B) the lost packet.

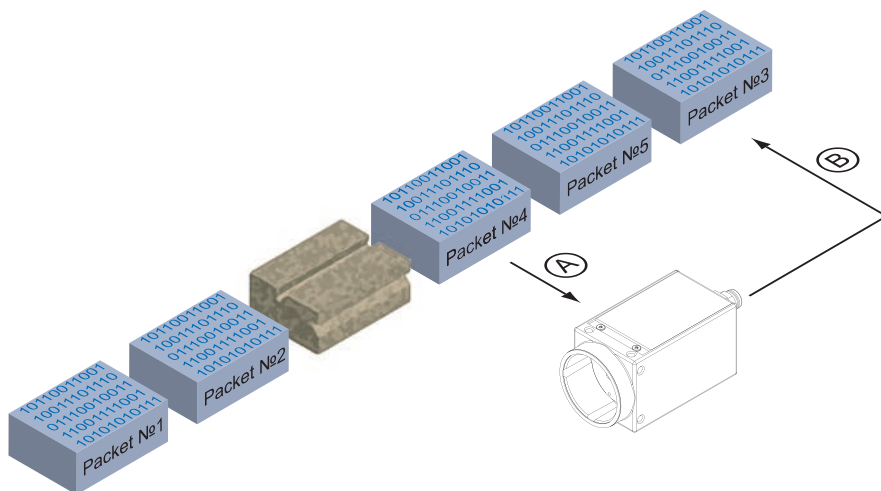

Resending lost packets within the data stream.

In our example packet no. 3 is lost. This fault is detected on packet no. 4, and the resend request triggered. Then the camera sends packet no. 5, followed by resending packet no. 3.

### 8.7.3 Fault 2: Lost Packet at the End of the Data Stream

In case of a fault at the end of the data stream, the application will wait for incoming packets for a predefined time. When this time has elapsed, the resend request is triggered and the "lost" packets will be resent.

Resending of lost packets at the end of the data stream.

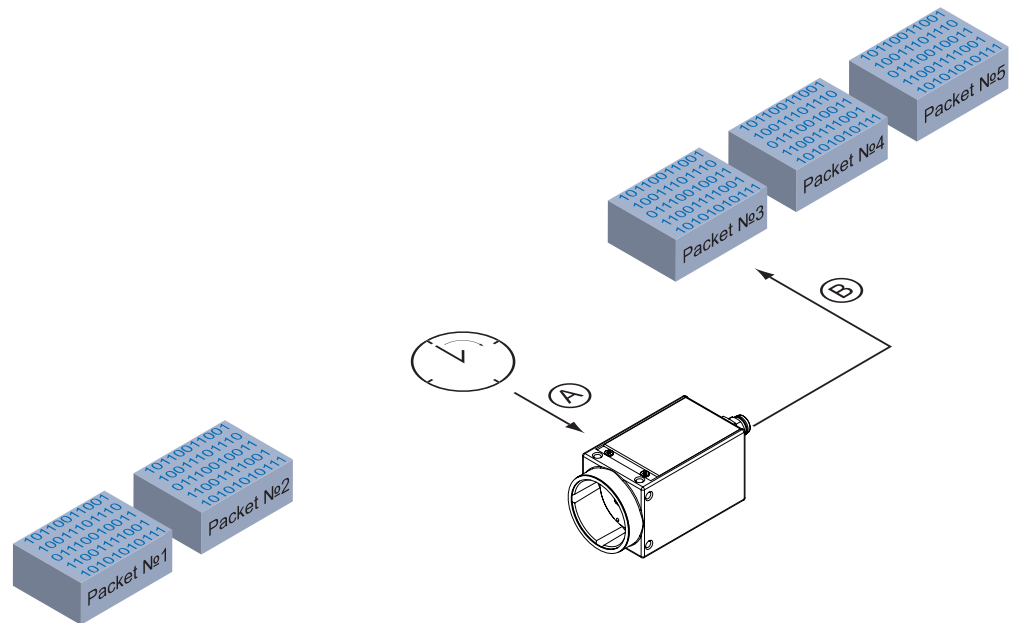

In our example, packets from no. 3 to no. 5 are lost. This fault is detected after the predefined time has elapsed and the resend request (A) is triggered. The camera then resends packets no. 3 to no. 5 (B) to complete the image transfer.

### 8.7.4 Termination Conditions

The resend mechanism will continue until:

- all packets have reached the pc
- the maximum of resend repetitions is reached
- the resend timeout has occurred or
- the camera returns an error.



## 8.8 Message Channel

The asynchronous message channel is described in the GigE Vision® standard and offers the possibility of event signaling. There is a timestamp (64 bits) for each announced event, which contains the accurate time the event occurred.

Each event can be activated and deactivated separately.

### 8.8.1 Event Generation

Event	Description
<b>GenICam™</b>	
ExposureStart	Exposure started
ExposureEnd	Exposure ended
FrameStart	Acquisition of a frame started
FrameEnd	Acquisition of a frame ended
Line0RisingEdge	Rising edge detected on IO-Line 0
Line0FallingEdge	Falling edge detected on IO-Line 0
Line1RisingEdge	Rising edge detected on IO-Line 1
Line1FallingEdge	Falling edge detected on IO-Line 1
Line2RisingEdge	Rising edge detected on IO-Line 2
Line2FallingEdge	Falling edge detected on IO-Line 2
Line3RisingEdge	Rising edge detected on IO-Line 3
Line3FallingEdge	Falling edge detected on IO-Line 3
Line4RisingEdge	Rising edge detected on IO-Line 4
Line4FallingEdge	Falling edge detected on IO-Line 4
Line5RisingEdge	Rising edge detected on IO-Line 5
Line5FallingEdge	(VCXG.I / .XT /.PTP / .I.PTP only) Falling edge detected on IO-Line 5
Line6RisingEdge	Rising edge detected on IO-Line 6
Line6FallingEdge	Falling edge detected on IO-Line 6
Line7RisingEdge	Rising edge detected on IO-Line 7
Line7FallingEdge	Falling edge detected on IO-Line 7
<b>Vendor-specific</b>	
EventError	Error in event handling.
EventLost	Occured event not analyzed.
TriggerReady	$t_{\text{notready}}$ elapsed, camera is able to process incoming trigger.
TriggerOverlapped	Overlapped Mode detected.
TriggerSkipped	Camera overtriggered.
FrameTransferSkipped	Frame lost in the camera.
TransferBufferFull	No free buffer in camera memory.
TransferBufferReady	Buffer available in camera memory.
HeartBeatTimeout	The device runs in heartbeat timeout.
PrimaryApplicationSwitch	For systems where redundancy and fault recovery are required, it is often necessary for a second application to take control over the camera that is already under the control of a primary application. In order to notify the primary application that a switchover has occurred, send this event before granting access to new primary application.

## 8.9 Action Command / Trigger over Ethernet

The basic idea behind this feature was to achieve a simultaneous trigger for multiple cameras.

### Action Command:

Since hardware release 2.1 the implementation of the Action Command follows the regulations of the GigE Vision® standard 1.2.

Therefore a broadcast Ethernet packet was implemented. This packet can be used to induce a trigger as well as other actions.

Due to the fact that different network components feature different latencies and jitters, the trigger over the Ethernet is not as synchronous as a hardware trigger. Nevertheless, applications can deal with these jitters in switched networks, and therefore this is a comfortable method for synchronizing cameras with software additions.

The action command is sent as a broadcast. In addition it is possible to group cameras, so that not all attached cameras respond to a broadcast action command.

Such an action command contains:

- a Device Key - for authorization of the action on this device
- an Action ID - for identification of the action signal
- a Group Key - for triggering actions on separated groups of devices
- a Group Mask - for extension of the range of separate device groups
- a Action Time - only present for Scheduled Action Commands when a future action time is specified (.PTP only)

### 8.9.1 Example: Triggering Multiple Cameras

The figure below displays three cameras, which are triggered synchronously by a software application.

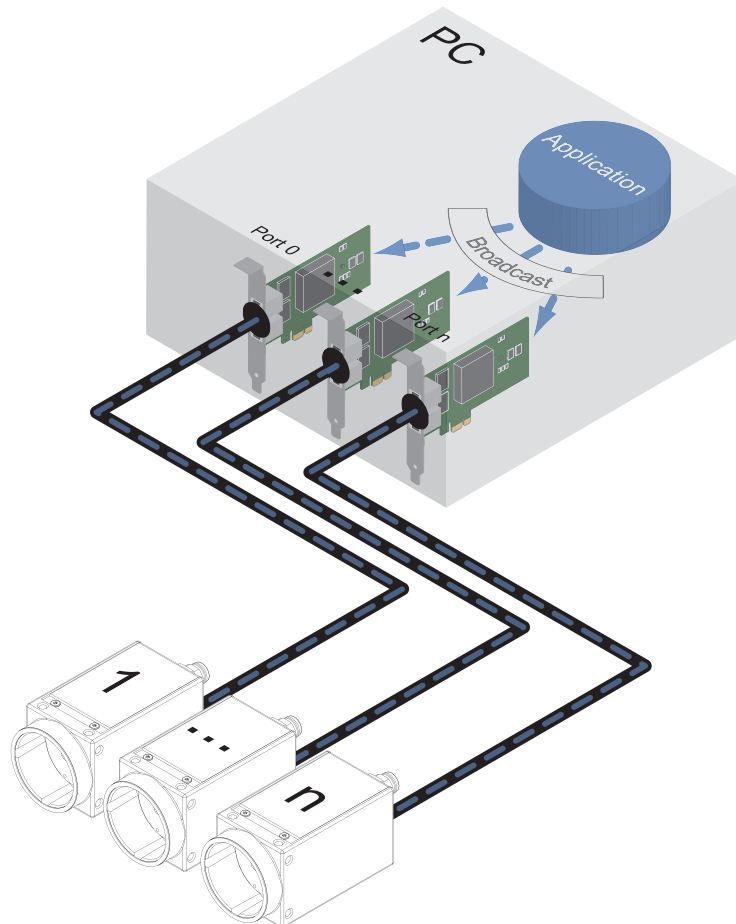

Triggering of multiple cameras via trigger over Ethernet (ToE).

Another application of action command is that a secondary application or PC or one of the attached cameras can actuate the trigger.

## 9. VCXU – Interface Functionalities

### 9.1 Device Information

This information on the device is part of the camera's USB descriptor.

Model Name	Baumer USB Vendor ID [Hexadecimal]	Baumer USB Product ID [Hexadecimal]
VCXU-02M	2825	137
VCXU-02C	2825	136
VCXU-04M	2825	159
VCXU-04C	2825	15A
VCXU-13M	2825	13B
VCXU-13C	2825	13A
VCXU-15M	2825	13D
VCXU-15C	2825	13C
VCXU-23M	2825	0128
VCXU-23C	2825	0129
VCXU-24M	2825	0130
VCXU-24C	2825	0131
VCXU-25M	2825	13F
VCXU-25C	2825	13E
VCXU-31M	2825	141
VCXU-31C	2825	140
VCXU-32M	2825	143
VCXU-32C	2825	142
VCXU-50M	2825	12A
VCXU-50MP	2825	162
VCXU-50C	2825	12B
VCXU-51M	2825	145
VCXU-51C	2825	144
VCXU-53M	2825	12E
VCXU-53C	2825	12F
VCXU-65M.R	2825	153
VCXU-65C.R	2825	154
VCXU-90M	2825	147
VCXU-90C	2825	146
VCXU-123M	2825	14B
VCXU-123C	2825	14A
VCXU-124M	2825	15B
VCXU-124C	2825	15C
VCXU-125M.R	2825	155
VCXU-125C.R	2825	156
VCXU-201M.R	2825	157
VCXU-201C.R	2825	158

Included information:

- Vendor ID (VID)
- Product ID (PID)
- General Unique Identifier (GUID)
- Device vendor name (Manufacturer)
- Serial number (iSerialNumber)

