

Quickstart



DST53-AxxxU

Strain sensor with voltage output and IO-Link

Dimensional drawing

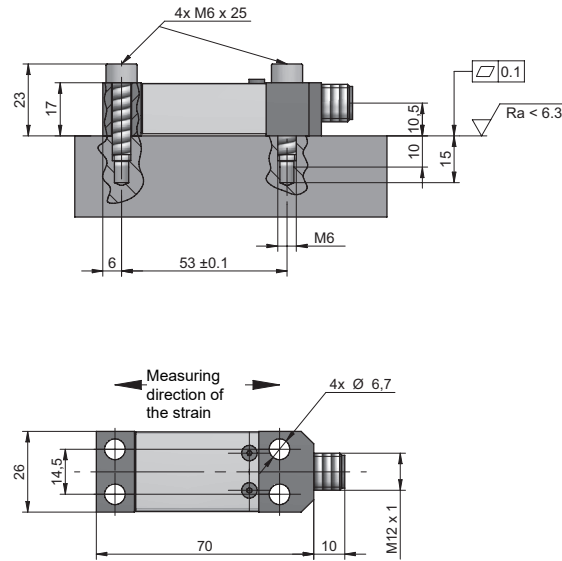

Applicable documents

- Download from www.baumer.com:
 - Operating manual
 - Data sheet
 - EU Declaration of Conformity
- Attached to product:
 - General information sheet (11042373)

Scope of delivery

- 1 x sensor
- 4 x screws M6x25, quality 12.9

Structure

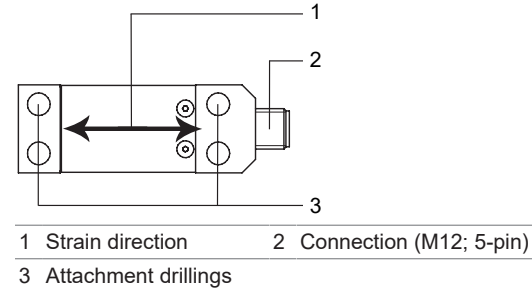

- 1 Strain direction
- 2 Connection (M12; 5-pin)
- 3 Attachment drillings

Functionality

The sensor is screwed to a machine element and measures its strain. Changes in the strain are measured with strain gauges and converted into an electrical signal. If the sensor experiences a tensile force, the signal is positive; if it experiences a compression, the signal is negative. The signal output is either an analog or digital (IO-Link) signal. The sensor is parameterized via the integrated IO-Link interface.

FAQ

The sensor does not output a stable signal. What is the reason for this?

The sensor is not screwed on tightly. To obtain stable measurement results, the sensor must be firmly screwed onto a machine element.

EN

Baumer Electric AG

Hummelstrasse 17
 CH-8501 Frauenfeld, Switzerland
 ☎ +41 (0) 52 728 11 55
 info@baumer.com

For further Baumer contacts go to:
www.baumer.com

Right of modifications reserved
 3/2/2022, 81376273, V2
 ID 18014398672252171

Dehnungssensor / strain sensor

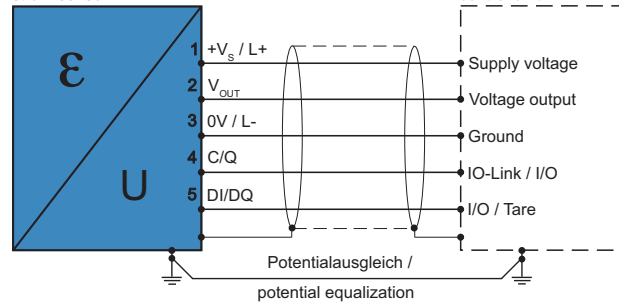

Output signal: $V_{OUT} = \pm 10$ V, parameterizable
 Operating voltage range: $+Vs = 18$ to 30 VDC

Disconnect the system from power before connecting the device. Power supply according to UL 1310, Class 2 or external protection via a UL-approved or listed fuse with max. 100 W/Vp or max. 5 A below 20 V.
 Note on electromagnetic compatibility: Shielded connection cable is recommended. Ground the cable shield on both sides over a large surface and ensure potential equalization.
 Connection cable length max. 20 m.

1	+Vs / L+
2	V_{OUT}
3	0V / L-
4	C/Q (IO-Link / SIO1)
5	DI/DQ (SIO2)
Housing	Shield

Factory settings (for standard type)

Output signal (at V_{OUT}):	± 10 VDC
SIO1:	Inactive
SIO2:	Teach-in offset, tare

Preparing the installation

Baumer recommends mounting on structures with blind holes. For thin structures, the sensor can also be mounted with through holes. In this case, make sure that the structure is sufficiently rigid.

NOTICE

The sensor supplies imprecise measurement results if the measuring surface is soiled or if the sensor is installed incorrectly.

- Prevent soiling from grease and oil.
- Mount the sensor on a machined, flat surface.
- Observe the surface roughness.

Mounting option with blind holes

Instruction:

- Check the flatness tolerance.
Flatness tolerance ≤ 0.1 mm

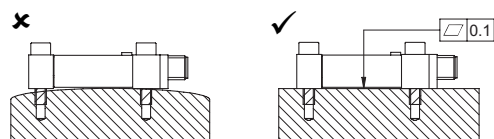

- Check the surface roughness.
Surface roughness ≤ 6.3 μm

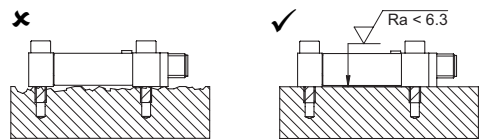

- Drill 4 threads into the machine element. Make sure to drill the holes perpendicular to the contact surface of the sensor.
 - Drill hole spacing: $53 \text{ mm} \pm 0.1$; $14.5 \text{ mm} \pm 0.2$
 - Depth of drill holes: ≥ 15 mm
 - Depth of thread: ≥ 10 mm

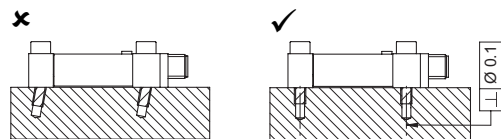
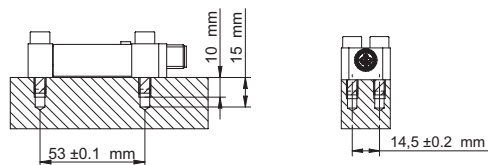

Mounting option with through holes

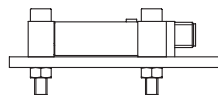

Mounting the sensor

INFO

The supplied screws (M6×25) are designed for mounting on steel. Use longer screws (M6×30) for mounting on light or non-ferrous metals.

The following describes mounting on steel:

Instruction:

- Make sure that the machine element is not loaded.
- Screw in the screws hand-tight.
- Tighten the screws (hexagon socket SW5) cross-wise in 2 stages with a torque wrench to a tightening torque of 18 Nm.

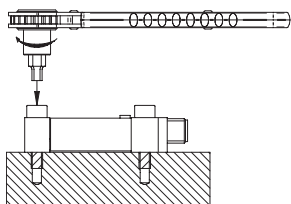

Putting the sensor into operation for the first time

For commissioning, the sensor is connected directly to the controller. The output signal is an analog signal and is proportional to the strain.

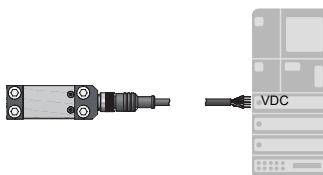

Instruction:

- To minimize the effect of settlement, fully load the sensor 10 times, if possible.
- With the power supply switched on, allow the sensor to warm up for 5 minutes to stabilize the zero point.
- Tare the sensor at zero load to compensate for signal changes due to mounting.

Result:

- ✓ The sensor is ready for operation.

Operation

Taring the sensor

Tare the sensor cyclically in the unloaded state to compensate for zero drift or temperature influences.

Instruction:

- Make sure that the sensor does not experience any change in strain.
- Make sure that the machine element is at the correct zero position.
- Tare the sensor at zero load (voltage signal *High* or via IO-Link).

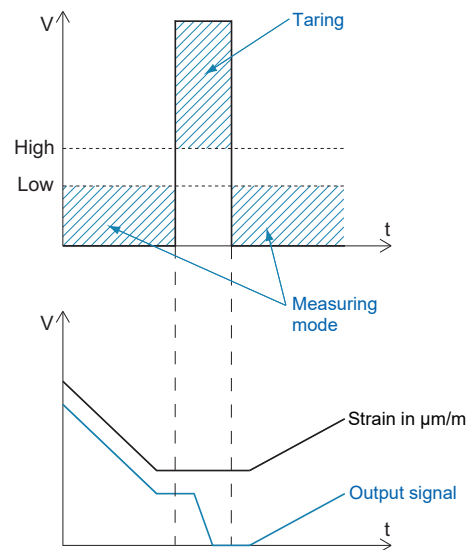

NOTICE

SIO1 and SIO2 with input function

SIOs operated as input must not be floating but always be assigned to a defined level *High* or *Low*. Default SIO2 parameterization is as input *Teach-In Offset/Tare* function. If this functionality is not required, assign the input permanently to GND to prevent unintended taring.

Parameterization (optional)

To achieve even better measurement results, you have the option of parameterizing the sensor with the integrated amplifier electronics via the IO-Link interface to suit the application. For this purpose, the sensor is connected to an IO-Link master.



The operating manual, the IODD file for parameterizing the sensor, and information on accessories can be found at:

- www.baumer.com (-> product detail page) and
- ioddfinder.io-link.com

In the following, you will find a selection of the parameterizable functions of the sensor:

- Define the unit of the output process value (N, kN, $\mu\text{m}/\text{m}$, ...)
- Tare the sensor, e.g. after it has been mounted (distortion, *Teach-in offset*)
- Calibrate the sensor to a known force on the machine (*Teach-in by Reference*)
- Adapt the analog output signal to the actual strain present (e.g. max. output signal at $350 \mu\text{m}/\text{m}$)
- Peak value memory for reliable maximum value recognition in real time
- Low-pass filter for optimized signal-to-noise ratio and smoothing in case of signal fluctuations
- Sample & hold for precise measured values at defined times for precise settings
- Configurable switching outputs
- Diagnostic data (detailed device status, operating hours counter, quality bit)
- Error detection (alarm bit for display of invalid measuring signals, freely configurable signal value at analog output for error detection)

Preventive maintenance

The sensor is maintenance-free. No special preventive maintenance is required. Regular cleaning and regular checking of the plug connections are recommended.