

Through beam fiber optics

FSE 025B1001

dimension drawing

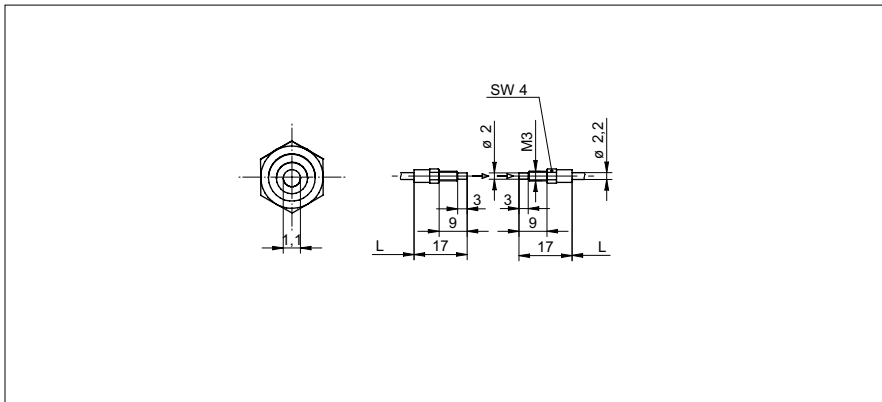

general data

type	through beam sensor
actual range Sb	140 mm
response time / release time	0,1 ... 1 ms
type of head (fiber optic cable)	cylindrical threaded (axial)
width / diameter (head)	3 mm
height / length (head)	17 mm
material (head)	brass
bending radius	7,5 mm (stat.) 15 mm (dynam.)
cable jacket diameter	2,5 mm
material cable jacket	PVC
fiber cross section	1 mm ²
material (fiber optic cable)	glass
length (fiber optic cable)	250 mm
operating temperature	-25 ... +70 °C

Sensing distance/response time:
For the definitive sensing distance/response time please see table below "fitting fiber optic sensors".

photo



fitting fiber optic sensors	actual range Sb (0,1 ms)	actual range Sb (0,25 ms)	actual range Sb (0,5 ms)	actual range Sb (1 ms)
FVDM 15	125 mm	-	-	140 mm