

CFDK 25G3125/LN1

Näherungsschalter

Proximity sensor

DéTECTEUR de proximité



11093422



Baumer Electric AG · CH-8501 Frauenfeld
Phone +41 (0)52 728 1122 · Fax +41 (0)52 728 1144

*Abmessungen
Dimensions
Dimensions*

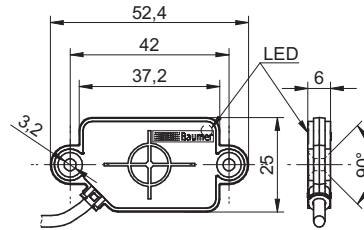

- Alle Masse in mm
- All dimension in mm
- Toutes les dimensions en mm

*Elektrischer Anschluss
Connection diagram
Schéma de raccordement*

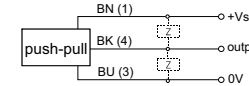

BN = Braun/brown/brun
BK = Schwarz/black/noir
BU = Blau/blue/bleu

- Vor dem Anschliessen des Sensors die Anlage spannungsfrei schalten.
- Disconnect power before connecting the sensor.
- Mettre l'installation hors tension avant le raccordement du détecteur.

Canada
Baumer Inc.
CA-Burlington, ON L7M 4B9
Phone +1 (1)905 335-8444

Italy
Baumer Italia S.r.l.
IT-20090 Assago, MI
Phone +39 (0)2 45 70 60 65

China
Baumer (China) Co., Ltd.
CN-201612 Shanghai
Phone +86 (0)21 6768 7095

Singapore
Baumer (Singapore) Pte. Ltd.
SG-339412 Singapore
Phone +65 6396 4131

Denmark
Baumer A/S
DK-8210 Aarhus V
Phone: +45 (0)8931 7611

Sweden
Baumer A/S
SE-56133 Huskvarna
Phone +46 (0)36 13 94 30

France
Baumer SAS
FR-74250 Fillinges
Phone +33 (0)450 392 466

Switzerland
Baumer Electric AG
CH-8501 Frauenfeld
Phone +41 (0)52 728 1313

Germany
Baumer GmbH
DE-61169 Friedberg
Phone +49 (0)6031 60 07 0

United Kingdom
Baumer Ltd.
GB-Watchfield, Swindon, SN6 8TZ
Phone +44 (0)1793 783 839

India
Baumer India Private Limited
IN-411058 Pune
Phone +91 20 66292400

USA
Baumer Ltd.
US-Southington, CT 06489
Phone +1 (1)860 621-2121

www.baumer.com/worldwide

Technische Daten

Technical data

Données techniques

Nennschaltabstand Sn	Nominal sensing distance Sn	Portée nominale Sn	2 mm
Einbautart	Mounting type	Type de montage	bündig/flush/noyé
Ausgangsschaltung	Output circuit	Circuit de sortie	Gegentakt Öffner/push-pull NC
Betriebsspannungsbereich +Vs	Voltage supply range +Vs	Plage de tension +Vs	10...30 VDC (UL Class 2)
Stromaufnahme max.	Current consumption max.	Consommation max.	< 15 mA
Ausgangsstrom	Output current	Courant de sortie	100 mA
Schaltfrequenz	Switching frequency	Fréquence de commutation	< 35 Hz
Kurzschlussfest	Short circuit protection	Protégé contre courts-circuits	Ja/yes/oui
Verpolungsfest	Reverse polarity protection	Protégé contre inversion polarité	Ja/yes/oui
Material (aktive Fläche)	Material (sensing face)	Matériau (face active)	PA 12
Gehäusematerial	Housing material	Matériau du boîtier	PA 12
Schutzklasse	Protection class	Classe de protection	IP65
Arbeitstemperatur	Operating temperature	Température de fonctionnement	-25...+75°C

Montagearten
Mounting versions
Types de montage

Mit Senkkopfschrauben
 With countersunk screw
 Avec vis à tête fraisée

Mit Kabelbinder
 With cable ties
 Avec colliers serre-câbles

Mit Klettband
 With Velcro strip
 Avec bande Velcro

Kaskadierte Montage
 Cascaded mounting
 Montage en cascade

Fixierung mit Klebepads oder Klebstoff
 Fixation with adhesive pads or glue
 Fixation avec supports adhésifs ou avec de la colle

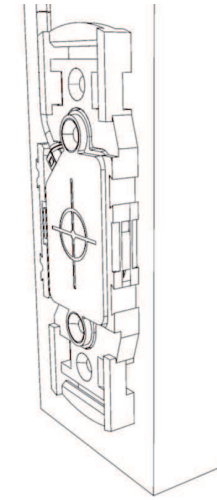
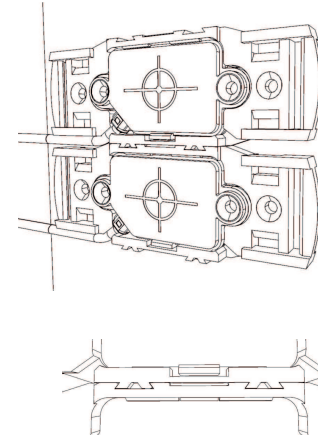
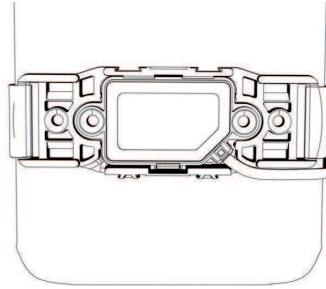
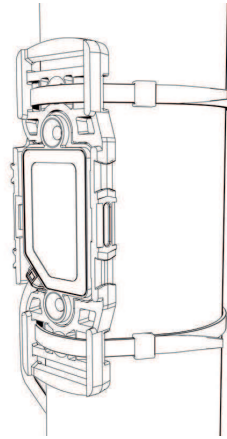
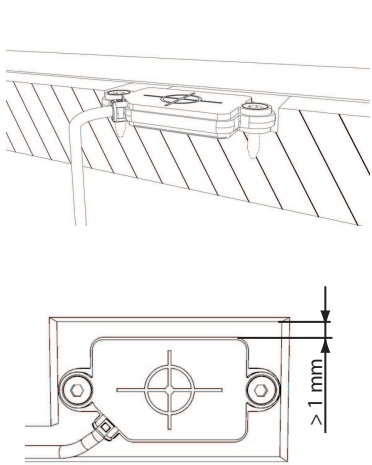

Zubehör
Accessories
Accessoires

Montagekit für CFDK 25
 Mounting kit for CFDK 25
 Kit de montage pour CFDK 25

Bestehend aus / consisting of / composé de:
 - 1x Montagerahmen HC25 / mounting frame HC25 / cadre de montage HC25
 - 2x Kabelbinder 186x4,7mm / cable ties 186x4,7mm / colliers serre-câbles 186x4,7mm
 - 2x Klebepads / adhesive pads / supports adhésifs /
 - 2x Distanznocken / spacers / entretoises

Bestellbezeichnung / order reference / référence de la commande
 HC25-1 Kit CFDK 25

Klettband für Montagerahmen HC25
 Velcro strip for mounting frame HC25
 Bande Velcro pour cadre de montage HC25

Bestellbezeichnung / order reference / référence de la commande

BX 20-360-1	l = 360 mm
BX 20-1200-1	l = 1200 mm
BX 20-2000-1	l = 2000 mm
BX 20-4000-1	l = 4000 mm

Snap-in Ohne Werkzeug
 Without tools
 Sans outils

1. Rahmen befestigen
1. Fix the frame
1. Fixer le cadre

2. Sensor einklicken
2. Snap in the sensor
2. Encliqueter le détecteur

3. Fertig
3. Ready
3. Terminé

